

Icon Index



Recessed Installation



Surface mounted installation



Track installation



Suspended installation



Wall mounted



Spike light installation

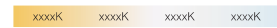

Color temperature



Beam Angle



Voltage



Power Factor



CRI



Ingress Protection



IK Rating



Dimmable



2.4G Intelligent Control



Wifi Intelligent Control



Remote Control



Sensor Control



Bluetooth Control



Music Functionality



SENSOR FUNCTION



Emergency Function



Smart Lighting



Unified Glare Rating



Wall Switch CCT Changeable Function



RGB Color Adjustable Function



Slide Switch CCT Changeable Function



Tunable White



Dim to Warm



Installed Directly into the Insulation



Standard Deviation Colour Matching



Classification TP(a)



Classification TP(b)



Vertical Rotation



Horizontal Rotation

CONTENTS

LED DOWNLIGHTS

Ultrathin Series
P06-23



LED DOWNLIGHTS

Integrated Series
P24-35



LED DOWNLIGHTS

COB Series
P36-75



CONTENTS

LED DOWNLIGHTS

COB Series
P36-75



RL01-C / P70



CL99 / P71



CL67 / P72



CL68 / P73



RD02&RD03 / P74



RD04&RD05 / P75

LED DOWNLIGHTS

Deep-down Series
P76-82



DL178 / P76



DL179 / P77



DL138A / P78



DL138B / P78



DL98A / P79



DL98B / P79



DL98C / P80



DL83 / P81



CL94 / P82

LED DOWNLIGHTS

Surface mounted
&Pendant Series
P84-99



DL207 / P84



DL176 / P86



DL38 / P87



DL129 / P88



DL130 / P89



DL160 / P90



DL51 / P92



DL52 / P93



DL115A / P94



DL115B / P94



PD05A / P95

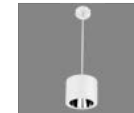

PD05B / P95

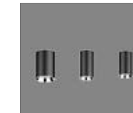

PD02A / P96



PD02B / P97



PD12 / P98



PD12B / P99

LED DOWNLIGHTS

Surface mounted
&Pendant Series
P84-99



AL53 / P102



AL54 / P103



AL08 / P104



AL12 / P105



AL37 / P106



AL38 / P107



AL85 / P108



AL87 / P109



AL24A / P110



AL24B / P111



AL41A / P112



AL41B / P113



AL47 / P114



AL47S / P115



AL25 / P116



AL45 / P117



AL02A / P118



AL02B / P119



AL51 / P120



AL52 / P121



AL71 / P122



AL55A / P123



AL55B / P123



AL42 / P124



AL48 / P125

LED CEILING LIGHT

P100 -125

CONTENTS

LED TRACK LIGHT

P126-169



LED TRACK LIGHT

P126-169



LED PANEL LIGHTS

P170-195

CONTENTS

LED LINEAR BATTEN LIGHT

P196-215

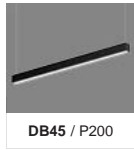

LED TUBE LIGHT

P216-223

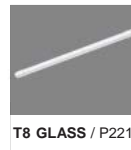
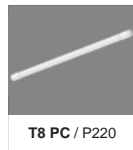
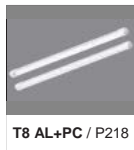

LED WALL & SPIKE LIGHT

P224-243

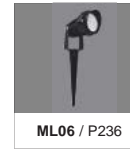

LED WALL & SPIKE LIGHT

P224-243



LED SPOT LIGHTS

P244-252



Tunable white Function introduced:



2-channel modules – wide range of colour temperatures

The 2-channel modules optimally cover the colour spectrum from 2,700 to 6,500 Kelvin. The different colour temperatures are generated using cool white and warm white LEDs, with two terminals available for each.

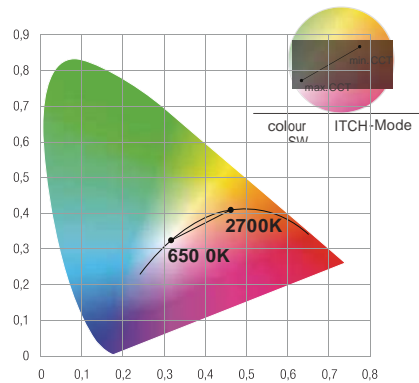

2-channel driver DT8 – constant colorimetric locus across all dimming levels

The second generation drivers guarantee even greater room for maneuver in terms of design with the enhanced dimming range of 3% to 100%. Colour temperatures are controlled precisely and with infinite variability, while the drivers reliably maintain the selected range across all dimming levels. The colour SWITCH function makes it possible to select the colour temperature, while the light can be dimmed with the switch DIM function. With the PREMIUM category drivers, the Tunable White solution can be controlled via DT8 using a push button or touch panel.

Tunable white Technology application:



Healthcare

- Improved patient rest and recovery
- Assists shift workers with staying alert while on duty
- Integrates simply with existing Controls



Behavioral Health

- Reduces sleep disturbance
- Helps prepare residents for sleep (circadian entrainment)
- Reduces depression



Senior Care

- Reduces agitation
- Improves sleep quality
- Reduces reliance on certain medications



Education

- Promotes higher level of student alertness
- Promotes higher cognitive performance in the classroom
- Improves testing and focus



Correctional

- Keeps staff mentally alert during overnight shifts
- Helps inmates maintain daily circadian rhythms
- Reduces agitation and irritability



Clean room/Vivarium

- Office workers with lighting that mimics natural patterns experience better sleep and less depression
- Helps entrain laboratory animals ensuring more accurate research outcomes

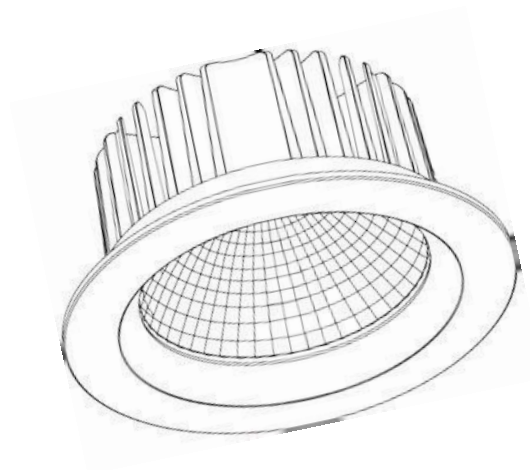

LED Downlight /Series/

LED downlight series provide turn-key lighting solutions in domestic and commercial applications. Our downlight is a combination of technique and emotion. We offer our customers a platform to experience the good quality and lighting effects with unique design, 100lm/w and more, UGR<19, Ra80 and Ra90, smart function. ELWA LED downlight family provides different solutions for project and distribution with different product types: COB/SMD version, IP54/IP44/ IP20, recessed/surface mounted/pendant, different sizes, different watts.



DL210 Downlight



DL210 LED downlight boosts its ultra slim design and flat cover, which adopts high lumen SMD LED and PC diffuser to ensure the soft and uniform light. ADC12 Aluminum profile provides excellent heat dissipation. IP54 waterproof for front side, it can be widely used for indoor lighting.

Model	Watt	Size(AxBmm)	Cut-out(mm)	Lumen(±5)	N.W/pc(kgs)	Q'ty/CTN
DL210-3-10W	10W	Ø110x30	Ø90-95	960lm	0.25	36PCS
DL210-3-12W	12W	Ø110x30	Ø90-95	1150lm	0.25	36PCS
DL210-4-12W	12W	Ø145x30	Ø120-130	1270lm	0.35	30PCS
DL210-4-18W	18W	Ø145x30	Ø120-130	1980lm	0.35	30PCS
DL210-6-18W	18W	Ø190x30	Ø160-170	1930lm	0.5	18PCS
DL210-6-25W	25W	Ø190x30	Ø160-170	2750lm	0.5	18PCS
DL210-8-25W	25W	Ø225x34	Ø200-210	2630lm	0.65	12PCS
DL210-8-35W	35W	Ø225x34	Ø200-210	3570lm	0.65	12PCS

CCT



Finish



DL97 Downlight

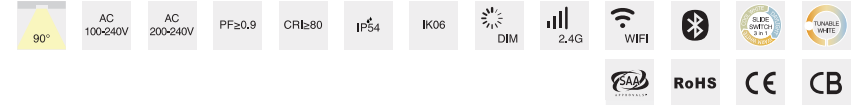

DL97 Down light adopts high lumen SMD LED, PC diffuser with even light output. White & silver treatment are available for customer's preference. Triac dimmable, 0-10V dimmable and DALI dimmable version share great popularity for excellent dimming effect.

Model	Watt	Size(AxBmm)	Cut-out(mm)	Lumen(±5)	N.W/pc(kgs)	Q'ty/CTN
DL97-2.5-7W	7W	Ø85x39	Ø70-75	590lm	0.2	50PCS
DL97-3-10W	10W	Ø100x38	Ø90-95	980lm	0.25	36PCS
DL97-3-13W	13W	Ø100x38	Ø90-95	1300lm	0.25	36PCS
DL97-3.5-13W	13W	Ø120x45	Ø100-110	1230lm	0.31	30PCS
DL97-4-15W	15W	Ø145x45	Ø120-130	1600lm	0.46	30PCS
DL97-5-18W	18W	Ø170x45	Ø140-150	2070lm	0.52	30PCS
DL97-6-18W	18W	Ø190x45	Ø160-170	1900lm	0.66	20PCS
DL97-6-25W	25W	Ø190x45	Ø160-170	2680lm	0.66	20PCS
DL97-6-35W	35W	Ø190x45	Ø160-170	3900lm	0.66	20PCS
DL97-8-18W	18W	Ø228x45	Ø200-210	2050lm	0.81	10PCS
DL97-8-25W	25W	Ø228x45	Ø200-210	2650lm	0.81	10PCS
DL97-8-35W	35W	Ø228x45	Ø200-210	4025lm	0.81	10PCS

CCT



Finish



CL59 Downlight



CL59 LED Downlight adopts high lumen SMD LED, PMMA diffuser with even light output. It's the top-selling downlight in 2018, which boosts its complete size and functions, such as wall switch, slide switch, wifi, 2.4G, emergency and sensor. IP20/IP44 for indoor use only. Triac dimmable, 0-10V dimmable and DALI dimmable version share great popularity.

Model	Watt	Size(AxBmm)	Cut-out(mm)	Lumen(±5)	N.W/pc(kgs)	Q'ty/CTN
CL59-2-7W	7W	Ø80x39	Ø60-70	480lm	0.28	50PCS
CL59-2.5-10W	10W	Ø85x39.5	Ø70-75	730lm	0.24	50PCS
CL59-3-10W/-F	10W	Ø100x38	Ø90-100	720lm	0.28	24PCS
CL59-3-12W/-F	12W	Ø110x38	Ø90-100	1170lm	0.28	24PCS
CL59-3-13W/-F	13W	Ø110x38	Ø90-100	950lm	0.28	24PCS
CL59-3.5-13W	13W	Ø120x39	Ø100-110	1150lm	0.45	24PCS
CL59-4-13W	13W	Ø145x45	Ø120-130	950lm	0.59	30PCS
CL59-4-18W	18W	Ø145x45	Ø120-130	1450lm	0.59	30PCS
CL59-5-18W	18W	Ø170x45	Ø140-150	1550lm	0.695	30PCS
CL59-5-25W	25W	Ø170x45	Ø140-150	2100lm	0.695	30PCS
CL59-6-18W	18W	Ø190x45	Ø160-170	1560lm	0.825	20PCS
CL59-6-25W	25W	Ø190x45	Ø160-170	2130lm	0.825	20PCS
CL59-6-35W	35W	Ø190x45	Ø160-170	2830lm	0.825	20PCS
CL59-8-18W	18W	Ø228x45	Ø200-210	1540lm	0.94	10PCS
CL59-8-25W	25W	Ø228x45	Ø200-210	2130lm	0.94	10PCS
CL59-8-35W	35W	Ø228x45	Ø200-210	2790lm	0.94	10PCS
CL59-10-45W	45W	Ø280x52	Ø230-260	4170lm	1.6	10PCS

CCT



Finish



DL04 Downlight



DL04 SMD LED Downlight is flat-cover design with great heat dissipation. It adopts high lumen SMD LED, UL94-V2 diffuser with even light output. White, silver surface treatments are available for wide choice. Triac dimmable, 0-10V dimmable and DALI dimmable version share great popularity.

Model	Watt	Size(AxBmm)	Cut-out(mm)	Lumen(±5)	N.W/pc(kgs)	Q'ty/CTN
DL04-4-12W	12W	Ø145x31.5	Ø120-135	1170lm	0.38	30PCS
DL04-6-18W	18W	Ø199x34.5	Ø170-190	1800lm	0.82	20PCS
DL04-8-24W	24W	Ø245x34.5	Ø210-235	2500lm	0.92	20PCS

CCT



Finish



DL147C Downlight



DL147C Round color changeable downlight with flicker free driver is controlled by slide switch, which aims to reduce your stock and enables end users to choose suitable color for different applications. It adopts high lumen SMD LED & PC 94-V0 diffuser with even light output.

Model	Watt	Size(AxBmm)	Cut-out(mm)	Lumen(±5)	N.W/pc(kgs)	Q'ty/CTN
DL147C-3-10W	10W	Ø103x38	Ø90-95	1000lm	0.32	24PCS

CCT



Finish



DL147F Downlight



DL147F Square color changeable downlight controlled by slide switch, which aims to reduce your stock and enables end users to choose suitable color for different applications. It adopts high lumen SMD LED & PC 94-V0 diffuser with even light output. Flicker-free driver are available.

Model	Watt	Size(AxAxBmm)	Cut-out(mm)	Lumen(±5)	N.W/pc(kgs)	Q'ty/CTN
DL147F-3-10W	10W	104x104x38	Ø90-95	1000lm	0.34	24PCS

CCT



Finish



CL22 Downlight

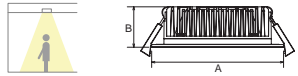

CL22 Downlight adopts high lumen SMD LED, PMMA diffuser with even light output. White, silver, chrome surface treatments are available. Triac dimmable, 0-10V dimmable and DALI dimmable version share great popularity by excellent dimming effect.

Model	Watt	Size(AxBmm)	Cut-out(mm)	Lumen(±5)	N.W/pc(kgs)	Q'ty/CTN
CL22-2.5-7W	7W	Ø85x31	Ø70-75	480lm	0.35	50PCS
CL22-2.5-10W	10W	Ø85x31	Ø70-75	740lm	0.35	50PCS
CL22-3-10W	10W	Ø104x31	Ø90-95	900lm	0.38	24PCS
CL22-3-13W	13W	Ø104x31	Ø90-95	1075lm	0.38	24PCS

CCT



Finish



DL44 Downlight

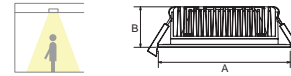

DL44 downlight is structural designed with integration of heatsink and surface cover, which aims to offer excellent dissipation. IP54 waterproof for indoor and outdoor use. PC 94-V0 diffuser provides high light transmittance and even light output. It is an ideal replacement for residential and commercial lighting.

Model	Watt	Size(AxBmm)	Cut-out(mm)	Lumen(±5)	N.W/pc(kgs)	Q'ty/CTN
DL44-3-10W	10W	Ø104x31	Ø90-95	790lm	0.26	24PCS
DL44-3-13W	13W	Ø104x31	Ø90-95	1070lm	0.26	24PCS

CCT



Finish



DL141 Downlight



DL141 downlight features PA46+Aluminum lamp body which provides excellent heat dissipation. PC diffuser ensures comfortable and uniform light. It can be with function of dimming, color changeable, Tuya etc. IP54 waterproof from front side, it can be widely used for indoor lighting.

Model	Watt	Size(AxBmm)	Cut-out(mm)	Lumen(±5)	N.W/pc(kgs)	Q'ty/CTN
DL141-3-10W	10W	Ø110x39.5	Ø90-100	830lm	0.18	24PCS
DL141B-3-10W	10W	Ø110x48	Ø90-100	950lm	0.21	24PCS

CCT

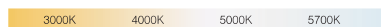

Finish



DL34 Downlight

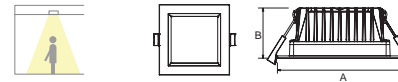

DL34 square LED downlight adopts high lumen SMD LED, PMMA diffuser with even light output. Triac dimmable, 0-10V dimmable and DALI dimmable version share great popularity by the excellent dimming effect.

Model	Watt	Size(AxAxBmm)	Cut-out(±5mm)	Lumen(±5)	N.W/pc(kgs)	Q'ty/CTN
DL34-3-13W	13W	110x110x44	90-95	940lm	0.4	24PCS
DL34-6-25W	25W	190x190x54	160-170	2300lm	1.11	12PCS

CCT



Finish



CL30 Downlight



CL30 tilted LED downlight as recessed design, adopts high lumen SMD LED, PMMA diffuser with even light output. Triac dimmable, 0-10V dimmable and DALI dimmable version share great popularity by excellent dimming effect.

Model	Watt	Size(AxBmm)	Cut-out(±5mm)	Lumen(±5)	N.W/pc(kgs)	Q'ty/CTN
CL30-13W	13W	Ø110x41.5	Ø95-100	900lm	0.4	24PCS

CCT



Finish



CL88 Downlight



CL88 downlight is designed as flat cover, tilted angle in horizontal rotation is 25 degree, creating diversified lighting effects. PMMA diffuser with high reflective transmittance creates even light output. It's an ideal replacement for customers who are environmentalists.

Model	Watt	Size(AxBmm)	Cut-out(mm)	Lumen(±5)	N.W/pc(kgs)	Q'ty/CTN
CL88-70-7W	7W	Ø85x28	Ø68	550lm	0.2	50PCS
CL88-90-10W	10W	Ø104x30	Ø90	800lm	0.28	34PCS

CCT



Finish



DL94 Downlight



ELWA ultra-thin LED downlight DL94 adopts side-emitting design, high lumen SMD LED, PMMA LGP with even light output. Equipped with AL6061 heating sink, 94-V0 rated PC housing and internal driver.

Model	Watt	Size(AxBmm)	Cut-out(±5mm)	Lumen(±5)	N.W/pc(kgs)	Q'ty/CTN
DL94-3-7W	7W	Ø110x30	Ø90-95	580lm	0.15	48PCS
DL94-6-16W	16W	Ø190x33	Ø160-170	1730lm	0.395	24PCS
DL94-8-20W	20W	Ø230x33	Ø200-210	2315lm	0.52	24PCS

CCT



Finish



DL110 Downlight



ELWA IP65 waterproof LED Down light DL110 adopts high lumen SMD LED, PMMA diffuser with even light output. Lamp body with IP65 rating designed can be widely used in indoor and outdoor applications.

Model	Watt	Size(AxBmm)	Cut-out(mm)	Lumen(±5)	N.W/pc(kgs)	Q'ty/CTN
DL110-3-13W	13W	Ø115x55.5	Ø95-100	1320lm	0.4	24PCS
DL110-4-18W	18W	Ø155x67	Ø120-130	1830lm	0.61	24PCS
DL110-6-25W	25W	Ø195x46.5	Ø175-185	2550lm	0.75	12PCS
DL110-8-35W	35W	Ø235x54.5	Ø205-215	3570lm	1.08	12PCS

CCT



Finish



DL161 Downlight

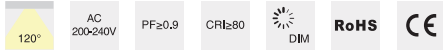

DL161 is a new designed downlight with indirect illumination. The light will be refracted by the lens and reflected back on the reflector to achieve the uniform illumination. It can fit perfectly with the ceiling.

Model	Watt	Size(AxBmm)	Cut-out(mm)	Lumen(±5)	N.W/pc(kgs)	Q'ty/CTN
DL161-6-10W	10W	Ø185x67	Ø160-170	700lm	0.42	12PCS
DL161-8-20W	20W	Ø228x88.4	Ø200-210	1520lm	0.59	12PCS

CCT



Finish



DL190 Downlight



DL190 LED recessed downlight adopts super slim (60mm thickness) and compact design, perfectly suitable for the narrow ceiling installation; the SMD LED combine with the lens bring the uniform lighting output.

Model	Watt	Size(AxBmm)	Cut-out(mm)	Lumen(±5)	N.W/pc(kgs)	Q'ty/CTN
DL190-3-10W	10W	Ø100x60	Ø88-93	1040lm	0.223	24PCS

CCT



Finish



DL96 Downlight



Round designed DL96 downlight is less than 40mm thickness with built-in driver, Grilling design effectively reduce the UGR index. Luminous efficiency 110lm/w. Equipped with push button looping connection terminal (LL-NN-EE), the simple structure provides easy access to installation and high security.

Model	Watt	Size(AxBmm)	Cut-out(mm)	Lumen(±5)	N.W/pc(kgs)	Q'ty/CTN
DL96-3-10W	10W	Ø110x40	Ø90-95	1070lm	0.22	30PCS
DL96-6-18W	18W	Ø190x40	Ø160-170	2070lm	0.44	24PCS
DL96-8-25W	25W	Ø228x40	Ø200-210	3000lm	0.7	20PCS

CCT



Finish



DL105 Downlight

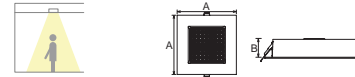

Square designed DL105 is less than 43.5mm thickness with built-in driver, Grilling design effectively reduces the UGR index. Luminous efficiency 110lm/w. Equipped with push button looping connection terminal (LL-NN-EE), the simple structure provides easy installation and high security.

Model	Watt	Size(AxAxBmm)	Cut-out(mm)	Lumen(±5)	N.W/pc(kgs)	Q'ty/CTN
DL105-3-10W	10W	110x110x39	90-95	1070lm	0.24	30PCS
DL105-6-18W	18W	190x190x43.5	160-170	2070lm	0.54	24PCS
DL105-8-25W	25W	228x228x43.5	200-210	3000lm	0.84	20PCS

CCT



Finish



DL134 Downlight



DL134 SMD LED downlight adopts high lumen SMD LED, PC diffuser with even light output. It is the special design with reflector to reduce the UGR index. Dimmable driver shares great popularity by the excellent dimming effect.

Model	Watt	Size(AxBmm)	Cut-out(mm)	Lumen(±5)	N.W/pc(kgs)	Q'ty/CTN
DL134-3-10W	10W	Ø115x83.4	Ø90-95	880lm	0.165	30PCS
DL134-4-13W	13W	Ø145x97.5	Ø125-130	1230lm	0.25	24PCS
DL134-6-16W	16W	Ø190x115.3	Ø160-170	1720lm	0.4	12PCS
DL134-8-20W	20W	Ø240x132.5	Ø200-210	2150lm	0.55	12PCS

CCT



Finish



DL41-S1 Downlight



DL41-S1 LED downlight with PIR sensor, Adopts advanced PIR sensor and PWM optic control module to reach a comfortable lighting effect. Uses a Fresnel lens with sensitive induction, wide detective beam angle and distance.

Model	Watt	Size(AxBmm)	Cut-out(mm)	Lumen(±5)	N.W/pc(kgs)	Q'ty/CTN
DL41-3-8W-S1	8W	Ø115x70	Ø90-95	730lm	0.2	30PCS
DL41-3-10W-S1	10W	Ø115x73	Ø90-95	880lm	0.2	30PCS

CCT



Finish



DL41/-B Downlight



DL41 SMD LED Down light as flat cover adopts high lumen SMD LED, PC diffuser with even light output and plastic coated aluminum housing. It is our most economical and practical downlight version with driver built-in. Dimmable driver shares great popularity by the excellent dimming effect.

Model	Watt	Size(AxBmm)	Cut-out(mm)	Lumen(±5)	N.W/pc(kgs)	Q'ty/CTN
DL41-2.5-7W	7W	Ø85x55	Ø70-75	620lm	0.12	50PCS
DL41-2.5-7W-P3	7W	Ø85x63	Ø70-75	650lm	0.12	50PCS
DL41-3-8W-D	8W	Ø115x58	Ø90-95	750lm	0.2	30PCS
DL41-3-8W-P3	8W	Ø115x61	Ø90-95	800lm	0.2	30PCS
DL41-3-10W	10W	Ø115x58	Ø90-95	880lm	0.2	30PCS
DL41-3-10W-P3	10W	Ø115x61	Ø90-95	940lm	0.2	30PCS
DL41B-4-13W-P3	13W	Ø145x62.5	Ø120-130	1320lm	0.22	30PCS
DL41B-6-16W-P3	16W	Ø190x75.5	Ø160-170	1840lm	0.51	30PCS
DL41B-8-20W-P3	20W	Ø225x84	Ø200-210	2200lm	0.635	20PCS

CCT



Finish

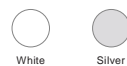

DL41D Downlight



DL41D SMD LED Down light adopts high lumen SMD LED, high light transmittance lens with even light output, plastic coated aluminum housing with internal driver design, triac dimmable version available; it shares great popularity by the excellent dimming effect.

Model	Watt	Size(AxBmm)	Cut-out(mm)	Lumen(±5)	N.W/pc(kgs)	Q'ty/CTN
DL41D-3-10W-D	10W	Ø115x58	Ø90-95	900lm	0.2	30PCS
DL41D-3-10W-P3	10W	Ø115x61	Ø90-95	980lm	0.2	30PCS

CCT



Finish



DL54 Downlight

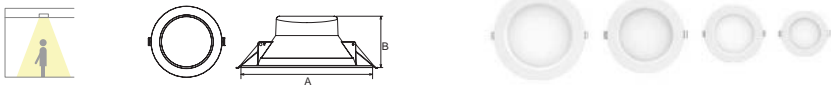

DL54 SMD LED Down light as recessed cover adopts high lumen SMD LED, PC diffuser and plastic coated aluminum housing. It is our most economical and practical downlight version with driver built-in. Dimmable driver shares great popularity by the excellent dimming effect.

Model	Watt	Size(AxBmm)	Cut-out(mm)	Lumen(±5)	N.W/pc(kgs)	Q'ty/CTN
DL54-3-10W	10W	Ø115x61	Ø90-95	920lm	0.2	30PCS
DL54-4-13W	13W	Ø145x61	Ø120-130	1100lm	0.28	30PCS
DL54-6-16W	16W	Ø190x74	Ø160-170	1550lm	0.51	30PCS
DL54-8-20W	20W	Ø225x84	Ø200-210	1840lm	0.635	20PCS
DL54B-3-8W	8W	Ø115x61	Ø90-95	750lm	0.2	30PCS
DL54B-3-10W	10W	Ø115x61	Ø90-95	920lm	0.2	30PCS
DL54B-4-13W	13W	Ø145x61	Ø120-130	1110lm	0.28	30PCS
DL54B-6-16W	16W	Ø190x74	Ø160-170	1570lm	0.51	30PCS
DL54B-8-20W	20W	Ø225x84	Ø200-210	1860lm	0.635	20PCS

CCT



Finish



DL102 Downlight

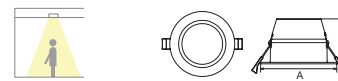

DL102 LED downlight complies with IC-4 certification requirements. The front cover and heat sink is a whole entity which can improve heat dissipation performance. With IP54 waterproof from front side, it can be widely applied to damp applications.

Model	Watt	Size(AxBmm)	Cut-out(mm)	Lumen(±5)	N.W/pc(kgs)	Q'ty/CTN
DL102-2.5-6W	6W	Ø85x65	Ø70-75	480lm	0.15	50PCS
DL102-3-8W	8W	Ø110x65	Ø90-95	640lm	0.22	36PCS

CCT



Finish



CL101 Downlight

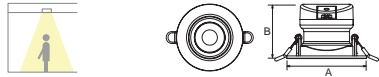

CL101 LED down light, adopts thermal plastic for better thermal dissipation and weight reduction, improves the stability, security, environmental protection of lamps. Lighting direction could be 0-30° adjustable which meet various illuminating demands.

Model	Watt	Size(AxBmm)	Cut-out(mm)	Lumen(±5)	N.W/pc(kgs)	Q'ty/CTN
CL101-2.5-7W	7W	Ø85x64.5	Ø70-75	660lm	0.2	36PCS
CL101-3-10W	10W	Ø105x71.5	Ø90-95	950lm	0.25	36PCS

CCT



Finish



White

DL91 Downlight

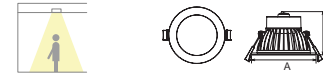

DL91 is an integrated led downlight, the PA46+Aluminum profile provides excellent thermal dissipation and cost saving. PC diffuser results comfortable and uniform light, 2 CCT changeable & 3 CCT changeable are available. IP54 design for room size.

Model	Watt	Size(AxBmm)	Cut-out(mm)	Lumen(±5)	N.W/pc(kgs)	Q'ty/CTN
DL91-3-8W-P2	8W	Ø107.5x71.5	Ø90-95	780lm	0.29	30PCS
DL91-3-10W-P2	10W	Ø107.5x71.5	Ø90-95	900lm	0.29	30PCS
DL91-3-8W-P3	8W	Ø107.5x71.5	Ø90-95	800lm	0.29	30PCS
DL91-3-10W-P3	10W	Ø107.5x71.5	Ø90-95	900lm	0.29	30PCS

CCT



Finish



White

DL121 Downlight

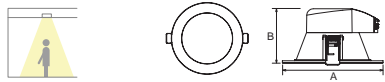

DL121 is an integrated led downlight with fast connector. Double L\N block terminal loop-in and loop-out toolless wiring makes it easy and fast for installation. It is with plastic body for cost saving. PC diffuser as uniform light, dimming version and color changeable available.

Model	Watt	Size(AxBmm)	Cut-out(mm)	Lumen(±5)	N.W/pc(kgs)	Q'ty/CTN
DL121-3-10W	10W	Ø115x62.5	Ø90-95	880lm	0.25	30PCS
DL121-3-10W-P3	10W	Ø115x64	Ø90-95	940lm	0.25	30PCS

CCT



Finish



DL86 Downlight

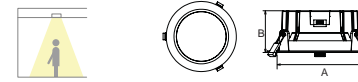

DL86 LED downlight complies with IC-4 certification requirements with integrated driver. The front cover and heat sink are a whole entity which can improve heat dissipation performance. With IP54 waterproof from front side, it can be widely applied to damp applications.

Model	Watt	Size(AxBmm)	Cut-out(mm)	Lumen(±5)	N.W/pc(kgs)	Q'ty/CTN
DL86-3-10W	10W	Ø110x60	Ø90-100	950lm	0.21	48PCS
DL86-6-20W	20W	Ø190x75	Ø160-170	2120lm	0.61	24PCS

CCT



Finish



DL143&DL144 Downlight

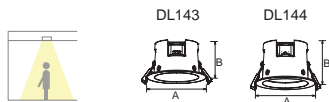

DL143 RGB LED down light adopts bluetooth wireless control system, which brings the management and regulating of lighting. Bluetooth RGB dimming Mesh Networking based on the development of a smart light control APP, which hundreds of devices can be with fast and stable connection. ADC12 material makes sure the perfect heat dissipation.

- Features:
1. Easy and convenient to control APP, support IOS/Android bluetooth 4.0 BLE protocol;
 2. Fully compatible with Bluetooth 4.0 BLE protocol;
 3. Max. 256pcs led lights in a network;
 4. Multi-function: group controlling, timing, scene setting, RGB & music melodies;
 5. Internal driver and control devices design makes the installation easier.

Model	Watt	Size(AxBmm)	Cut-out(mm)	Lumen(±5)	N.W/pc(kgs)	Q'ty/CTN
DL143-3-10W	10W	Ø110x64	Ø90-95	850lm	0.22	36PCS
DL144-3-10W	10W	Ø110x74	Ø90-95	780lm	0.24	36PCS

CCT

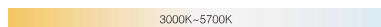

Finish

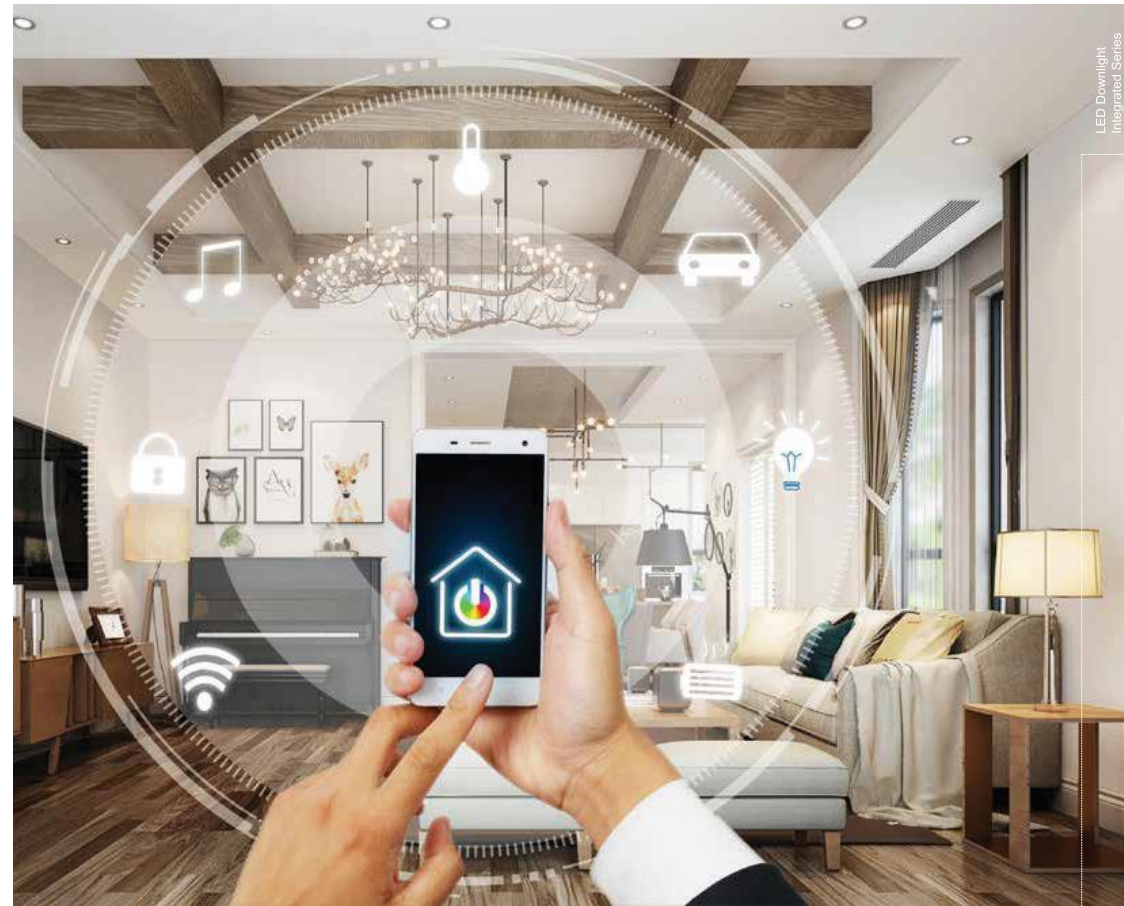

DL22 Downlight

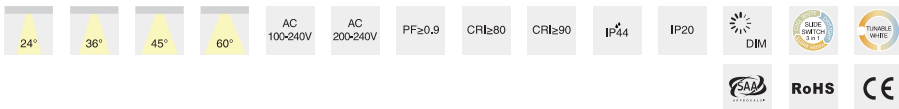

DL22 down light adopts brand CITIZEN COB, ADC12 aluminum ensures excellent heat dissipation, there are 3 different driver solutions for options:

C3: CCT switchable (Non-dimmable driver with external slide switch)

P3: CCT switchable+Triac dimmable (Triac dimmable driver with external slide switch)

TW: Tunable white (with Dual DALI driver which can meet DALI2 standard)

Model	Watt	Size(AxBmm)	Cut-out(mm)	Lumen(±5)	N.W/pc(kgs)	Q'ty/CTN
DL22-3-10W	10W	Ø110x53	Ø90-100	800lm	0.35	30PCS
DL22-3-13W	13W	Ø110x53	Ø90-100	1100lm	0.35	30PCS
DL22-4-18W	18W	Ø145x65	Ø120-130	2105lm	0.85	20PCS
DL22-4-25W	25W	Ø145x65	Ø120-130	2580lm	0.85	20PCS
DL22-6-18W	18W	Ø190x75	Ø160-170	2160lm	1.04	12PCS
DL22-6-25W	25W	Ø190x75	Ø160-170	2875lm	1.04	12PCS
DL22-6-35W	35W	Ø190x75	Ø160-170	3955lm	1.08	12PCS
DL22-6-45W	45W	Ø190x75	Ø160-170	4770lm	1.08	12PCS
DL22-8-18W	18W	Ø225x87	Ø200-210	2160lm	1.48	12PCS
DL22-8-25W	25W	Ø225x87	Ø200-210	2800lm	1.48	12PCS
DL22-8-35W	35W	Ø225x87	Ø200-210	3955lm	1.48	12PCS
DL22-8-45W	45W	Ø225x87	Ø200-210	4770lm	1.48	12PCS

CCT



Finish



DL113 Downlight

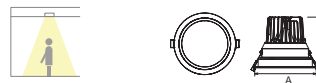

DL113 down light is unique designed with reflector and COB high power LED chip. ADC12 Aluminum profile provides excellent thermal dissipation. It is an ideal choice for commercial lighting.

Model	Watt	Size(AxBmm)	Cut-out(mm)	Lumen(±5)	N.W/pc(kgs)	Q'ty/CTN
DL113-4-13W	13W	Ø150x123	Ø135-140	1520lm	0.85	12PCS
DL113-4-20W	20W	Ø150x123	Ø135-140	2280lm	0.85	12PCS
DL113-4-25W	25W	Ø150x123	Ø135-140	2810lm	0.85	12PCS

CCT



Finish



DL77 Downlight

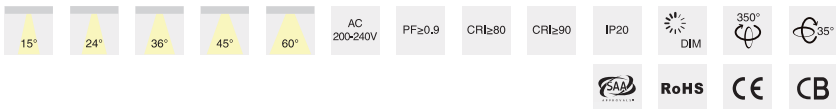

DL77 down light is unique designed with reflector. It adopts Citizen COB and ADC12 die-casting aluminium body. Adjustable lighting direction provides all possible lighting effects. Isolated driver solution both in dimmable and non-dimmable version achieves great dimming compatibility with worldwide brand dimmers.

Model	Watt	Size(AxBmm)	Cut-out(mm)	Lumen(±5)	N.W/pc(kgs)	Q'ty/CTN
DL77-2.5-10W	10W	Ø96x68	Ø85-90	800lm	0.25	36PCS
DL77-4-15W	15W	Ø145x102	Ø120-130	1800lm	0.57	18PCS
DL77-4-20W	20W	Ø145x102	Ø120-130	2100lm	0.57	18PCS
DL77-6-35W	35W	Ø180x128.5	Ø165-170	3800lm	1.07	12PCS
DL77-6-45W	45W	Ø180x128.5	Ø165-170	5080lm	1.07	12PCS

CCT



Finish



DL31 Downlight

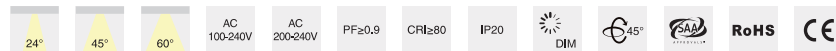

ELWA DL31 COB downlight is unique designed with reflector and Citizen COB high power LED chip. ADC12 die-casting aluminium profile provides excellent thermal dissipation. Adjustable lighting direction provides all possible lighting effects. Isolated driver solution both in dimmable and non-dimmable version achieves great dimming compatibility with worldwide brand dimmers.

Model	Watt	Size(AxBmm)	Cut-out(mm)	Lumen(±5)	N.W/pc(kgs)	Q'ty/CTN
DL31-2.5-13W	13W	Ø96x67	Ø85-88	945lm	0.39	24PCS
DL31-6-18W	18W	Ø180x100	Ø160-170	1500lm	1.41	12PCS
DL31-6-25W	25W	Ø180x100	Ø160-170	2550lm	1.41	12PCS
DL31-6-35W	35W	Ø180x100	Ø160-170	3550lm	1.41	12PCS

CCT



Finish



CL108 Downlight



CL108 is scoop design COB down light which can be spliced; High quality COB ensures reliable quality, ADC12 die-casting aluminium profile provides excellent thermal dissipation. Adjustable lighting direction provides all possible lighting effects. 15°/24°/36°/45°/60° beam angle are all available. Isolated driver solution both in dimmable and non-dimmable version achieves great dimming compatibility with worldwide brand dimmers.

Model	Watt	Size(AxAxBmm)	Cut-out(mm)	Lumen(±5)	N.W/pc(kgs)	Q'ty/CTN
CL108-2.5-10W	10W	100x100x70	85-85	780lm	0.29	36PCS
CL108-4-15W	15W	145x145x107	125-125	1290lm	0.6	18PCS
CL108-4-20W	20W	145x145x107	125-125	2100lm	0.6	18PCS
CL108-6-35W	35W	180x180x129	165-165	3800lm	1.07	12PCS
CL108-6-45W	45W	180x180x129	165-165	4350lm	1.07	12PCS

CCT



Finish



DL122 Downlight



DL122 is a led COB downlight with interchangeable reflector design, 3 different beam angle reflectors for optional. Adjustable lighting direction design can meet various demands. Triac dimmable version achieves great dimming compatibility with worldwide brand dimmers. Aluminium profile provides excellent thermal dissipation.

Model	Watt	Size(AxBmm)	Cut-out(mm)	Lumen(±5)	N.W/pc(kgs)	Q'ty/CTN
DL122-4-18W	18W	Ø150x116	Ø130-140	1820lm	0.71	12PCS
DL122-4-25W	25W	Ø150x116	Ø130-140	2430lm	0.71	12PCS
DL122-6-25W	25W	Ø185x130	Ø160-170	2420lm	1.1	12PCS
DL122-6-35W	35W	Ø185x130	Ø160-170	3260lm	1.1	12PCS
DL122-6-42W	42W	Ø185x130	Ø160-170	3780lm	1.1	12PCS

CCT



Finish



CL113A Downlight

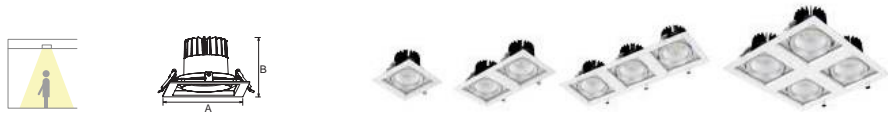

CL113A is a recessed commercial down light, modular splicing available. It adopts brand CITIZEN COB, high reflective rate reflector and ADC12 Aluminum heat sink. The module can be adjusted from any directions to 30 degrees, practical for accent lighting and decorative lighting.

Model	Watt	Size(AxAxBmm)	Cut-out(mm)	Lumen(±5)	N.W/pc(kgs)	Q'ty/CTN
CL113A-6-25W	25W	175x175x110	150-160	2750lm	0.83	18PCS
CL113A-6-35W	35W	175x175x110	150-160	3850lm	0.83	18PCS

CCT

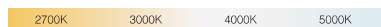

Finish



CL113B Downlight



CL113B is a recessed commercial down light. It adopts brand CITIZEN COB chip, high reflective rate reflector and ADC12 Aluminum heat sink. The module can be adjusted from any directions to 30 degrees, and practical for accent lighting and decorative lighting.

Model	Watt	Size(AxBmm)	Cut-out(mm)	Lumen(±5)	N.W/pc(kgs)	Q'ty/CTN
CL113B-6-25W	25W	Ø180x110	Ø150-160	2750lm	0.79	18PCS
CL113B-6-35W	35W	Ø180x110	Ø150-160	3850lm	0.79	18PCS

CCT



Finish



DL170 Downlight

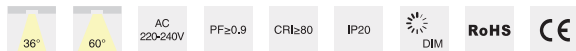

L1

R1



L

R

DL170 is a trim cover exchangeable modular downlight. It adopts AL6063 Aluminum heat sink and brand Citizen COB LED. The modular comes with two optional optical modules: reflector type and lens type. Different cover options.

Model	Watt	Size(AxBxCmm)	Cut-out(mm)	Lumen(±5)	N.W/pc(kgs)	Q'ty/CTN
DL170-10W	10W	Ø50x61	Trim	1000lm	0.17	100PCS
DL170-13W	13W	Ø50x61	Trim	1490lm	0.17	100PCS
DL170-18W	18W	Ø50x81	Trim	2130lm	0.25	50PCS
DL170-75-A	Trim	Ø85x46.8x75	Ø75-80	Trim	0.075	100PCS
DL170-90-A	Trim	Ø100x45.8x90	Ø90-95	Trim	0.09	100PCS
DL170-100-A	Trim	110x35x95	95-100	Trim	0.16	80PCS
DL170-90-B	Trim	Ø100x64x90	Ø90-95	Trim	0.095	100PCS
DL170-75-B1	Trim	Ø85x34.5x70	Ø70-80	Trim	0.11	100PCS
DL170-75-B2	Trim	Ø85x34.5x70	Ø70-80	Trim	0.11	100PCS
DL170-75-C	Trim	Ø90x24.8x70	Ø70-80	Trim	0.07	100PCS
DL170-90-D	Trim	Ø110x32x90	Ø90-95	Trim	0.105	100PCS
DL170-90-E	Trim	100x50x90	90-95	Trim	0.115	100PCS

CCT



Finish



DL170 DIY module

DL170-75-A

DL170-90-A

DL170-100-A

DL170-90-B

DL170-75-B1

DL170-75-B2

DL170-75-C

DL170-90-D

DL170-90-E

DL206 Downlight

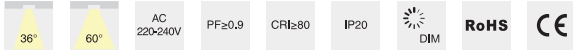

DL206 LED down light with modular design, two optional bracket modules (Fixed and Rotary type). The rotary module can be adjusted 355° horizontally and 25° vertically. With 36° and 60° lens for options, they're easy and convenient to replace.

Model	Watt	Size(AxBxCmm)	Cut-out(mm)	Lumen(±5)	N.W/pc(kgs)	Q'ty/CTN
DL206-10W	10W	Ø49x72	Trim	850lm	0.16	30PCS
DL206-20W	20W	Ø66x91	Trim	2300lm	0.35	20PCS
DL206-25W	25W	Ø87x105	Trim	2700lm	0.56	20PCS
DL206-35W	35W	Ø102x104	Trim	3450lm	0.74	20PCS
DL206-3A	Trim	Ø100x40x83	Ø85-90	Trim	0.17	60PCS
DL206-3B	Trim	Ø100x53x83	Ø85-90	Trim	0.16	60PCS
DL206-4A	Trim	Ø140x53x115	Ø120-130	Trim	0.29	40PCS
DL206-4B	Trim	Ø140x71x115	Ø120-130	Trim	0.32	40PCS
DL206-5A	Trim	Ø160x71x140	Ø145-150	Trim	0.41	20PCS
DL206-5B	Trim	Ø160x84.5x140	Ø145-150	Trim	0.4	20PCS

CCT



Finish



DL206 DIY module

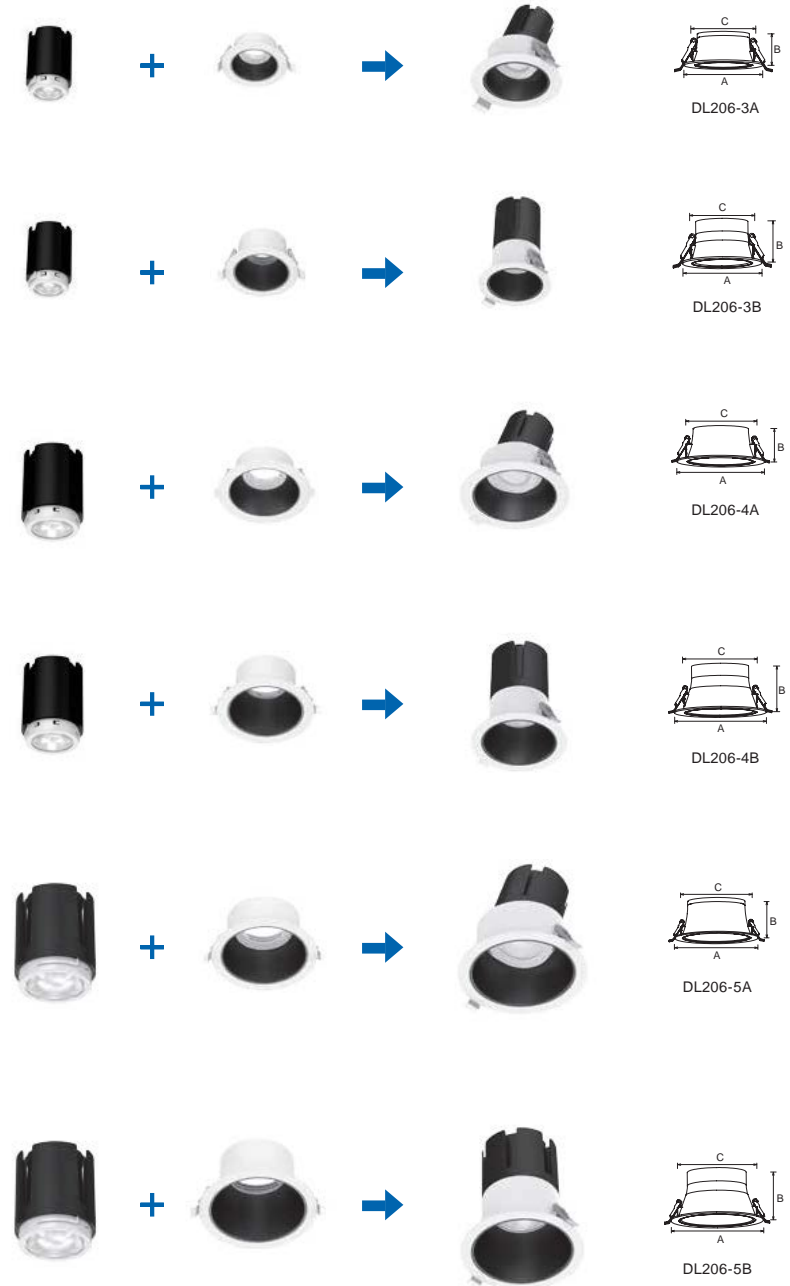

DL201 Downlight



DL201 down light with traditional deep reflector (UGR<19) provides perfect combination of high lighting efficiency, comfortable lighting and humanization design without compromising on light performance (color rendering and color uniformity). It offers a wide option for creating the desired ambience.

Model	Watt	Size(AxBmm)	Cut-out(mm)	Lumen(±5)	N.W/pc(kgs)	Q'ty/CTN
DL201A-2.5-10W	10W	Ø80x87	Ø75	910lm	0.26	36PCS
DL201B-2.5-10W	10W	Ø85x81	Ø75	910lm	0.27	36PCS
DL201-3-13W	13W	Ø100x94	Ø90	1170lm	0.315	24PCS
DL201-3.5-13W	13W	Ø105x145	Ø100	1100lm	0.375	24PCS

CCT



Finish



CL123 Downlight

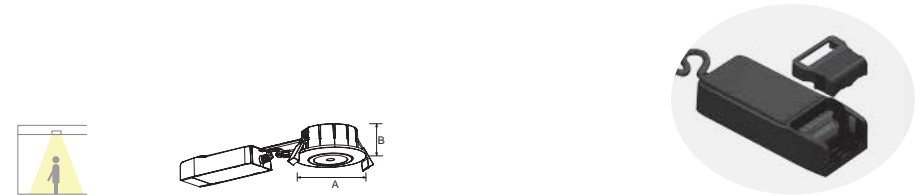

CL123 down light is a special design for low mounting depth(33mm). It is suitable for covering with insulation material directly. With replaceable driver, Loop-in/out design makes the installation and maintenance easier.

Model	Watt	Size(AxBmm)	Cut-out(mm)	Lumen(±5)	N.W/pc(kgs)	Q'ty/CTN
CL123-3-6W	6W	Ø88x38	75-83	540lm	0.23	48PCS

CCT

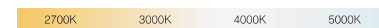

Finish



CL117&CL118 Downlight



CL117&CL118 down light are designed for low mounting depth; With optional modular and interchangeable bracket, they can be combined into four types; With replaceable driver, Loop-in/out design makes the installation and maintenance easier.

Model	Watt	Size(AxBmm)	Cut-out(mm)	Lumen(±5)	N.W/pc(kgs)	Q'ty/CTN
CL117A-2.5-6W	6W	Ø80x35	Ø68-75	530lm	0.185	48PCS
CL117B-2.5-6W	6W	Ø80x35	Ø68-75	500lm	0.19	48PCS
CL117A-3-6W	6W	Ø95x49	Ø82-88	570lm	0.25	36PCS
CL117B-3-6W	6W	Ø95x49	Ø82-88	530lm	0.275	36PCS
CL117A-3-8W	8W	Ø95x49	Ø82-88	785lm	0.25	36PCS
CL117B-3-8W	8W	Ø95x49	Ø82-88	765lm	0.275	36PCS
CL117A-3-10W	10W	Ø95x49	Ø82-88	1000lm	0.25	36PCS
CL117B-3-10W	10W	Ø95x49	Ø82-88	970lm	0.275	36PCS
CL118A-2.5-6W	6W	Ø80x33	Ø68-75	530lm	0.185	48PCS
CL118B-2.5-6W	6W	Ø80x33	Ø68-75	500lm	0.19	48PCS
CL118A-3-6W	6W	Ø95x44	Ø82-88	570lm	0.245	36PCS
CL118B-3-6W	6W	Ø95x44	Ø82-88	530lm	0.265	36PCS
CL118A-3-8W	8W	Ø95x44	Ø82-88	785lm	0.245	36PCS
CL118B-3-8W	8W	Ø95x44	Ø82-88	765lm	0.265	36PCS
CL118A-3-10W	10W	Ø95x44	Ø82-88	1000lm	0.245	36PCS
CL118B-3-10W	10W	Ø95x44	Ø82-88	970lm	0.265	36PCS

CCT



Finish



CL117&CL118 DIY module



CL102 Downlight



CL102 LED tilted recessed downlight adopts brand CITIZEN COB and anti-glare lens. IP65 rating front cover design is suitable for damp environment. T-shape heat sink greatly increases the radiation area and improves cooling efficiency.

Model	Watt	Size(AxBmm)	Cut-out(mm)	Lumen(±5)	N.W/pc(kgs)	Q'ty/CTN
CL102A-2.5-5W	5W	Ø80x30	Ø68-72	530lm	0.24	50PCS
CL102A-2.5-8W	8W	Ø80x30	Ø68-72	815lm	0.24	50PCS
CL102B-2.5-10W	10W	Ø90x39.3	Ø75-80	1000lm	0.25	50PCS
CL102-3-10W	10W	Ø110x49.5	Ø90-95	1000lm	0.4	30PCS
CL102-3-13W	13W	Ø110x49.5	Ø90-95	1350lm	0.4	30PCS

CCT

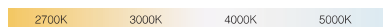

Finish



DL103 Downlight

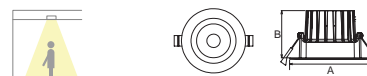

DL103 LED fixed recessed downlight adopts brand CITIZEN COB and anti-glare lens. IP65 rating front cover design is suitable for damp environment. T-shape heat sink greatly increases the radiation area and improves cooling efficiency.

Model	Watt	Size(AxBmm)	Cut-out(mm)	Lumen(±5)	N.W/pc(kgs)	Q'ty/CTN
DL103A-2.5-5W	5W	Ø80x40	Ø68-72	530lm	0.18	50PCS
DL103A-2.5-8W	8W	Ø80x40	Ø68-72	815lm	0.18	50PCS
DL103B-2.5-10W	10W	Ø90x49.4	Ø75-80	1000lm	0.265	50PCS
DL103-3-10W	10W	Ø110x64.3	Ø90-95	1000lm	0.45	30PCS
DL103-3-13W	13W	Ø110x64.3	Ø90-95	1350lm	0.45	30PCS

CCT



Finish



CL104 Downlight

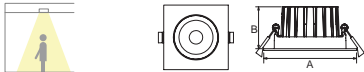

CL104 LED tilted square recessed downlight adopts brand CITIZEN COB and anti-glare lens. IP65 rating front cover design is suitable for damp environment. T-shape heat sink greatly increases the radiation area and improves cooling efficiency.

Model	Watt	Size(AxAxBmm)	Cut-out(mm)	Lumen(±5)	N.W/pc(kgs)	Q'ty/CTN
CL104A-2.5-5W	5W	80x80x30	Ø68-72	530lm	0.22	50PCS
CL104A-2.5-8W	8W	80x80x30	Ø68-72	815lm	0.22	50PCS
CL104B-2.5-10W	10W	90x90x39	Ø75-80	1000lm	0.255	50PCS
CL104-3-10W	10W	110x110x50	Ø90-95	1000lm	0.345	30PCS
CL104-3-13W	13W	110x110x50	Ø90-95	1350lm	0.345	30PCS

CCT

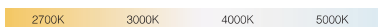

Finish



DL104 Downlight

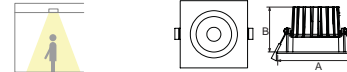

DL104 LED fixed square recessed downlight adopts brand CITIZEN COB and anti-glare lens. IP65 rating front cover design is suitable for damp environment. T-shape heat sink greatly increases the radiation area and improves cooling efficiency.

Model	Watt	Size(AxAxBmm)	Cut-out(mm)	Lumen(±5)	N.W/pc(kgs)	Q'ty/CTN
DL104A-2.5-5W	5W	80x80x40	Ø68-72	530lm	0.22	50PCS
DL104A-2.5-8W	8W	80x80x40	Ø68-72	815lm	0.22	50PCS
DL104B-2.5-10W	10W	90x90x49	Ø75-80	1000lm	0.275	50PCS
DL104-3-10W	10W	110x110x64	Ø90-95	1000lm	0.39	30PCS
DL104-3-13W	13W	110x110x64	Ø90-95	1350lm	0.39	30PCS

CCT



Finish



DL63 Downlight

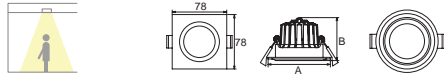

Mini down light DL63 is designed for cutout size of 70mm. 24°/36°/60° beam angle are available for different applications. With waterproof structural design with IP54 protection grade, it is the ideal for damp locations. Triac dim, 0-10V, DALI are available.

Model	Watt	Size(AxBmm)	Cut-out(mm)	Lumen(±5)	N.W/pc(kgs)	Q'ty/CTN
DL63-2.5-5W	5W	Ø80x55	Ø68-74	450lm	0.28	48PCS
DL63-2.5-8W	8W	Ø80x55	Ø68-74	590lm	0.28	48PCS
DL63-2.5-8W-P	8W	Ø80x55	Ø68-74	400lm	0.28	48PCS

CCT

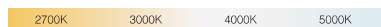

Finish



DL64 Downlight

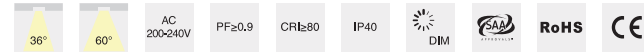

DL64 downlight adopts super high lumen COB and excellent light transmittance prismatic lens. 36°/60° beam angle are available. Cutout 70-75mm is an ideal replacement for traditional lamps.

Model	Watt	Size(AxBmm)	Cut-out(mm)	Lumen(±5)	N.W/pc(kgs)	Q'ty/CTN
DL64-2.5-10W	10W	Ø82x58	Ø70-75	1010lm	0.25	48PCS

CCT

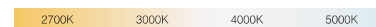

Finish



CL76 Downlight

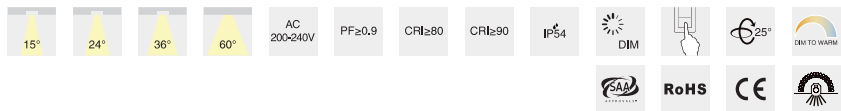

Mini down light CL76 is specially designed for European market with standard cutout size of 80mm. 15°/24°/36°/60° beam angle are provided. Combined of COB LED and PC reflector, it maximally reduces UGR down to 19 or even less. 25 degree flexible rotary head makes installation easier and better.

Model	Watt	Size(AxBmm)	Cut-out(mm)	Lumen(±5)	N.W/pc(kgs)	Q'ty/CTN
CL76-3-8W	8W	Ø95x55	Ø82-88	570lm	0.34	48PCS
CL76-3-10W	10W	Ø95x55	Ø82-88	770lm	0.34	48PCS
CL76-3-10W-P	10W	Ø95x55	Ø82-88	450lm	0.34	48PCS

CCT

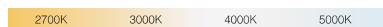

Finish



CL78 Downlight

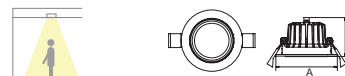
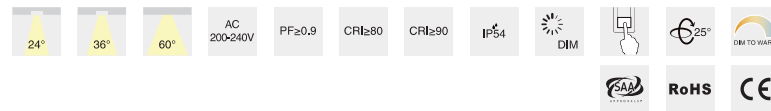

Mini down light CL78 with 24°/36°/60° beam angle is applicable for various lighting effects. With IP54 waterproof design, it is the ideal for damp locations. 25 degree flexible rotary head makes installation easier and better.

Model	Watt	Size(AxBmm)	Cut-out(mm)	Lumen(±5)	N.W/pc(kgs)	Q'ty/CTN
CL78-2.5-5W	5W	Ø80x50	Ø68-74	450lm	0.27	48PCS
CL78-2.5-8W	8W	Ø80x50	Ø68-74	600lm	0.27	48PCS
CL78-2.5-8W-P	8W	Ø80x50	Ø68-74	400lm	0.27	48PCS

CCT

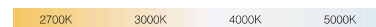

Finish



CL77 Downlight

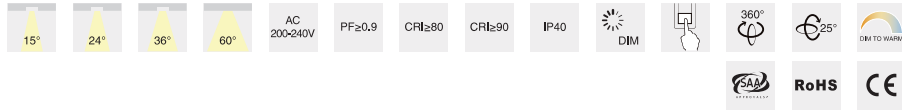

Patent mini down light CL77 is specially designed for European market. It adopts high-reflectivity PC reflector; it creates high lumen output with light transmittance up to 90%. Adjustable lighting direction provides all possible lighting effects. 360 degree rotates horizontally and 25 degree rotates vertically.

Model	Watt	Size(AxBmm)	Cut-out(mm)	Lumen(±5)	N.W/pc(kgs)	Q'ty/CTN
CL77-3-10W	10W	Ø100x58	Ø85-90	770lm	0.34	48PCS
CL77-3-10W-P	10W	Ø100x58	Ø85-90	450lm	0.34	48PCS

CCT



Ring



CL79 Downlight



Mini down light CL79 achieves 100lm/W high efficiency by adopting super high lumen COB and excellent light transmittance prismatic lens. It has adjustable head for different lighting directions. External power is supplied to make easy maintenance.

Model	Watt	Size(AxBmm)	Cut-out(mm)	Lumen(±5)	N.W/pc(kgs)	Q'ty/CTN
CL79-2.5-10W	10W	Ø90x46	Ø84	1010lm	0.26	48PCS

CCT

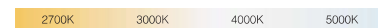

Finish



CL79A/B Downlight

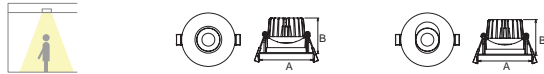

Mini down light CL79A/B achieves 100lm/W high efficiency by adopting super high lumen COB and excellent light transmittance prismatic lens. It has adjustable head for different lighting directions.

Model	Watt	Size(AxBmm)	Cut-out(mm)	Lumen(±5)	N.W/pc(kgs)	Q'ty/CTN
CL79A-2.5-10W	10W	Ø91.5x61	Ø84	800lm	0.26	48PCS
CL79B-2.5-10W	10W	Ø91.5x61	Ø84	800lm	0.26	48PCS

CCT



Finish



CL79C Downlight



Mini down light CL79C achieves 100lm/W high efficiency by adopting super high lumen COB and excellent light transmittance prismatic lens. It has adjustable head for different lighting directions.

Model	Watt	Size(AxAxBmm)	Cut-out(mm)	Lumen(±5)	N.W/pc(kgs)	Q'ty/CTN
CL79C-2.5-10W	10W	90x90x76	84x84	1020lm	0.3	48PCS

CCT



Finish



DL123 Downlight



Mini gimbal downlight DL123, adopts high lumen COB LED, high energy efficacy and high CRI and tight focus. DL123 downlight is ideally suitable for a variety of applications. With the adjustable and rotatable luminaire, it perfectly meets the demands of different lighting angle.

Model	Watt	Size(AxBmm)	Cut-out(mm)	Lumen(±5)	N.W/pc(kgs)	Q'ty/CTN
DL123-2.5-6W	6W	Ø80x37	Ø72-75	615lm	0.21	40PCS

CCT

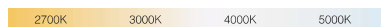

Finish



DL124 Downlight

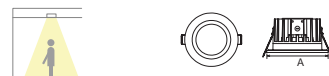

DL124 down light with smart optical design combines COB LED and PC reflector. It creates the most comfortable lighting environment. With waterproof IP65 structural design, it is the ideal for damp locations. Aluminum profile provides excellent thermal dissipation.

Model	Watt	Size(AxBmm)	Cut-out(mm)	Lumen(±5)	N.W/pc(kgs)	Q'ty/CTN
DL124-2.5-7W	7W	Ø90x50	Ø74x80	600lm	0.25	50PCS

CCT

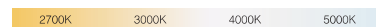

Finish



DL88 Downlight



DL88 down light is unique designed with reflector and COB. ADC12 Aluminum profile provides excellent thermal dissipation. Isolated driver solution both in dimmable and non-dimmable version achieves great dimming compatibility with worldwide brand dimmers.

Model	Watt	Size(AxBmm)	Cut-out(mm)	Lumen(±5)	N.W/pc(kgs)	Q'ty/CTN
DL88-2.5-10W	10W	Ø85x89	Ø68-75	860lm	0.27	24PCS
DL88-2.5-13W	13W	Ø85x89	Ø68-75	1190lm	0.27	24PCS
DL88-3-13W	13W	Ø110x98	Ø90-95	1190lm	0.35	24PCS

CCT



Finish



DL202 Downlight



DL202 LED under cabinet light with ADC12 aluminum light body, providing good heat dissipation. 70 degree beam angle with lens. Adopting 12V constant voltage driver, 3-way and 6-way distributor for options.

Model	Watt	Size(AxBmm)	Cut-out(mm)	Lumen(±5)	N.W/pc(kgs)	Q'ty/CTN
DL202-3.5W	3.5W	Ø70x17	Ø58	300lm	0.075*3	30*3PCS
driver with 3-way distributor	/	/	/	/	0.125	90PCS
driver with 6-way distributor	/	/	/	/	0.135	90PCS

CCT



Finish



RD01 Downlight



RD01 rectangular downlight is unique designed with COB high power LED chip. With IP65 waterproof designed for various applications, it is good for damp locations. AL6063 Aluminum profile provides excellent thermal dissipation. Isolated external driver solution achieves stable working performance.

Model	Watt	Size(AxBxCmm)	Cut-out(mm)	Lumen(±5)	N.W/pc(kgs)	Q'ty/CTN
RD01-35W	35W	235x145x117.4	220-130	3050lm	2.4	6PCS
RD01-45W	45W	235x145x117.4	220-130	3850lm	2.4	6PCS

CCT



Finish



RD01-B Downlight

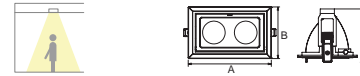

RD01-B rectangular downlight is unique designed with 2 COB chips. With IP65 waterproof designed for various applications, it is especially good for damp location. AL6063 Aluminum profile provides excellent thermal dissipation. Isolated external driver solution achieves stable working performance.

Model	Watt	Size(AxBxCmm)	Cut-out(mm)	Lumen(±5)	N.W/pc(kgs)	Q'ty/CTN
RD01-B-35W	35W	235x145x117.4	220-130	2970lm	2.4	6PCS
RD01-B-45W	45W	235x145x117.4	220-130	3900lm	2.4	6PCS

CCT



Finish



RD01-C Downlight

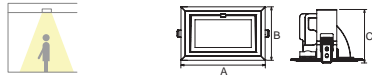

RD01-C SMD Rectangular downlight achieves high lumen output, 90° wide beam angle. AL6063 Aluminum profile provides excellent thermal dissipation. External driver solution achieves stable working performance design and easy maintenance. Tilt head provides various lighting direction for different applications. It is widely used for different commercial lighting situation.

Model	Watt	Size(AxBxCmm)	Cut-out(mm)	Lumen(±5)	N.W/pc(kgs)	Q'ty/CTN
RD01-C-40W	40W	246x156x115	225-130	3950lm	2.3	4PCS
RD01-C-60W	60W	246x156x115	225-130	5450lm	2.3	4PCS

CCT



Finish



CL99 Downlight

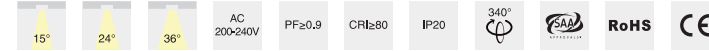

CL99 downlight is unique replaceable module design that makes the lamp more easily to install and maintain. The drivers are separated and external for replacement easily. It is an ideal for commercial lighting.

Model	Watt	Size(AxBxCmm)	Cut-out(mm)	Lumen(±5)	N.W/pc(kgs)	Q'ty/CTN
CL99-30W	30W	175x175x110	160-160	3100lm	1.25	12PCS
CL99-60W	60W	330x175x110	310-160	5800lm	2.25	6PCS
CL99-90W	90W	475x175x110	455-160	8800lm	3.2	6PCS

CCT



Finish



CL67 Downlight



CL67 square LED recessed commercial downlight adopts high-efficiency Citizen COB. It brings excellent lighting effect. Single head, double heads and triple heads provide wide choices for you. Adjustable lighting direction offers various lighting orientation.

Model	Watt	Size(AxBxCmm)	Cut-out(mm)	Lumen(±5)	N.W/pc(kgs)	Q'ty/CTN
CL67-30W	30W	175x175x135	160-160	3210lm	1.3	12PCS
CL67-60W	60W	330x175x135	310-160	6420lm	2.6	6PCS
CL67-90W	90W	475x175x135	455-160	9630lm	3.6	4PCS

CCT



Finish



CL68 Downlight



CL68 square LED recessed commercial downlight adopts high-efficiency COB. It brings excellent lighting effect. Single head 10W, double heads 20W and triple heads 30W provide wide choices for you. Adjustable lighting direction offers various lighting orientation.

Model	Watt	Size(AxBxCmm)	Cut-out(mm)	Lumen(±5)	N.W/pc(kgs)	Q'ty/CTN
CL68-10W	10W	110x110x63	90-90	820lm	0.33	30PCS
CL68-20W	20W	200x110x63	180-90	1650lm	0.6	20PCS
CL68-30W	30W	290x110x63	270-90	2400lm	0.83	20PCS

CCT

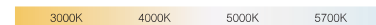

Finish



RD02&RD03 Downlight

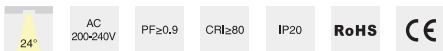

Frameless commercial downlight adopts brand CREE COB provides high lumen output. RD02 RD03 Single head, double heads and triple heads provide for wide choice. Adjustable lighting direction offers various lighting orientation.

Model	Watt	Size(AxBxCmm)	Cut-out(mm)	Lumen(±5)	N.W/pc(kgs)	Q'ty/CTN
RD02-8W	8W	155.5x83.5x134	86-86	550lm	1.3	12PCS
RD02-16W	16W	235.5x83.5x134	167-86	1250lm	1.9	6PCS
RD02-24W	24W	315.5x83.5x134	247-86	1700lm	2.5	6PCS
RD03-12W	12W	185x113x154	116-116	980lm	1.7	12PCS
RD03-24W	24W	294x113x154	228-116	2040lm	2.5	6PCS
RD03-36W	36W	404x113x154	338-116	2700lm	3.1	6PCS

CCT



Finish



RD04&RD05 Downlight

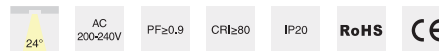

URD04 RD05 with brand CREE COB high power LED chip. Single head, double heads and triple heads provide for wide choice. Adjustable lighting direction offers various lighting orientation.

Model	Watt	Size(AxBxCmm)	Cut-out(mm)	Lumen(±5)	N.W/pc(kgs)	Q'ty/CTN
RD04-8W	8W	100x100x135	85-85	550lm	1.1	12PCS
RD04-16W	16W	180x100x135	165-85	1250lm	1.8	6PCS
RD04-24W	24W	260x100x135	245-85	1700lm	2.4	6PCS
RD05-12W	12W	130x130x155	115-115	980lm	1.6	12PCS
RD05-24W	24W	239x130x155	224-115	2040lm	2.4	6PCS
RD05-36W	36W	349x130x155	334-115	2700lm	3	6PCS

CCT



Finish



DL178 Downlight



DL178 downlight with traditional deep reflector (UGR<19) brings a good lighting effect for human beings, offering choices 24°/36°/ 60° beam angle. It adopts brand CITIZEN COB as high efficiency 110lm/W to save more energy.

Model	Watt	Size(AxBmm)	Cut-out(mm)	Lumen(±5)	N.W/pc(kgs)	Q'ty/CTN
DL178A-3-10W	10W	Ø95x54	Ø82-88	1120lm	0.23	36PCS
DL178B-3-10W	10W	Ø110x54	Ø90-95	1120lm	0.27	36PCS
DL178B-3-13W	13W	Ø110x54	Ø90-95	1300lm	0.27	36PCS
DL178-4-10W	10W	Ø145x78	Ø125-135	1150lm	0.475	18PCS
DL178-4-18W	18W	Ø145x78	Ø125-135	2250lm	0.475	18PCS
DL178-4-25W	25W	Ø145x78	Ø125-135	2750lm	0.475	18PCS
DL178-6-18W	18W	Ø172x90	Ø150-165	2200lm	0.705	12PCS
DL178-6-25W	25W	Ø172x90	Ø150-165	2850lm	0.705	12PCS
DL178-6-35W	35W	Ø172x90	Ø150-165	3670lm	0.705	12PCS
DL178-8-18W	18W	Ø228x99	Ø200-210	2070lm	1.135	12PCS
DL178-8-25W	25W	Ø228x99	Ø200-210	2850lm	1.135	12PCS
DL178-8-35W	35W	Ø228x99	Ø200-210	4000lm	1.135	12PCS
DL178-8-40W	40W	Ø228x99	Ø200-210	4200lm	1.135	12PCS
DL178-8-45W	45W	Ø228x99	Ø200-210	4700lm	1.135	12PCS

CCT



Finish



DL179 Downlight



DL179 SMD LED downlight with deep reflector provides comfortable lighting effect. High lumen 110lm/W, various size 3/4/6/8 inch available, 10W/18W/25W/35W for option, 3CCT, Triac dimmable, DALI, 0-10V meet various demands.

Model	Watt	Size(AxBmm)	Cut-out(mm)	Lumen(±5)	N.W/pc(kgs)	Q'ty/CTN
DL179A-3-10W	10W	Ø95x54	Ø82-88	800lm	0.225	36PCS
DL179B-3-10W	10W	Ø110x54	Ø90-95	800lm	0.265	36PCS
DL179B-3-13W	13W	Ø110x54	Ø90-95	1040lm	0.265	36PCS
DL179-4-10W	10W	Ø145x78	Ø125-135	900lm	0.455	18PCS
DL179-4-18W	18W	Ø145x78	Ø125-135	1800lm	0.455	18PCS
DL179-4-25W	25W	Ø145x78	Ø125-135	2550lm	0.455	18PCS
DL179-6-18W	18W	Ø172x90	Ø150-165	1900lm	0.665	12PCS
DL179-6-25W	25W	Ø172x90	Ø150-165	2650lm	0.665	12PCS
DL179-6-35W	35W	Ø172x90	Ø150-165	3180lm	0.665	12PCS
DL179-8-18W	18W	Ø228x99	Ø200-210	2070lm	1.08	12PCS
DL179-8-25W	25W	Ø228x99	Ø200-210	2800lm	1.08	12PCS
DL179-8-35W	35W	Ø228x99	Ø200-210	4000lm	1.08	12PCS
DL179-8-40W	40W	Ø228x99	Ø200-210	4400lm	1.08	12PCS
DL179-8-45W	45W	Ø228x99	Ø200-210	4950lm	1.08	12PCS

CCT



Finish



DL138A/B Downlight



As a perfect alternative to traditional ceiling mounted luminaries, DL138 is IP54 protection room side, suitable for bathrooms, kitchens. It is with external driver, triac, 0/1-10V, DALI dimmable, 3 CCT are all available. UGR<19 can be reached for DL138B 60° beam angle.

Model	Watt	Size(AxBmm)	Cut-out(mm)	Lumen(±5)	N.W/pc(kgs)	Q'ty/CTN
DL138-3-6W	6W	Ø110x70	Ø90-95	560lm	0.24	24PCS
DL138-4-13W	13W	Ø145x82	Ø125-135	1390lm	0.34	24PCS
DL138-6-18W	18W	Ø172x95	Ø150-165	1780lm	0.45	12PCS
DL138-8-18W	18W	Ø228x98	Ø200-210	2110lm	0.65	12PCS
DL138-8-25W	25W	Ø228x98	Ø200-210	2880lm	0.65	12PCS

CCT

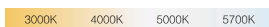

Finish



Re-Reflector



DL98A/B Downlight



ELWA integrated SMD LED downlight DL98 series, perfect alternative for traditional luminaire. DL98A with faceted reflector, at DL98B with specula reflector, UGR<19 can be reached for DL98B 60° beam angle. Integrated driver with fast connector provides fast and easy installation. 3/4/6/8 inch, 6/13/18/25W meet kinds of demand. Triac dimmable and 3 CCT are available.

Model	Watt	Size(AxBmm)	Cut-out(mm)	Lumen(±5)	N.W/pc(kgs)	Q'ty/CTN
DL98-3-6W	6W	Ø110x70	Ø90-95	610lm	0.18	24PCS
DL98-4-13W	13W	Ø145x82	Ø125-135	1460lm	0.28	24PCS
DL98-6-18W	18W	Ø172x95	Ø150-165	1890lm	0.35	12PCS
DL98-8-18W	18W	Ø228x98	Ø200-210	2110lm	0.54	12PCS
DL98-8-25W	25W	Ø228x98	Ø200-210	2930lm	0.54	12PCS

CCT

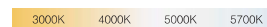

Finish



Re-Reflector



DL98C Downlight

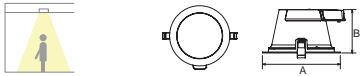

ELWA integrated SMD LED downlight DL98C with diffuser design provides fast and easy installation. 3/4/6/8 inch, 8/13/15/18/25W meet kinds of demand. Triac dimmable and 3CCT are available.

Model	Watt	Size(AxBmm)	Cut-out(mm)	Lumen(±5)	N.W/pc(kgs)	Q'ty/CTN
DL98C-3-8W	8W	Ø110x70	Ø90-95	810lm	0.18	24PCS
DL98C-4-13W	13W	Ø145x82	Ø125-135	1340lm	0.28	24PCS
DL98C-6-15W	15W	Ø172x95	Ø150-165	1670lm	0.35	12PCS
DL98C-6-18W	18W	Ø172x95	Ø150-165	1890lm	0.35	12PCS
DL98C-8-15W	15W	Ø228x98	Ø200-210	1770lm	0.54	12PCS
DL98C-8-18W	18W	Ø228x98	Ø200-210	2030lm	0.54	12PCS
DL98C-8-25W	25W	Ø228x98	Ø200-210	2750lm	0.54	12PCS

CCT

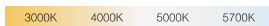

Finish



Re-Reflector



DL83 Downlight



ELWA DL83 SMD downlight is with micro prism diffuser, which results for uniform and comfortable lighting. It is an ideal choice for commercial lighting. Multiple choice 3/6/8 inch, 13/25/35W for you.

Model	Watt	Size(AxBmm)	Cut-out(mm)	Lumen(±5)	N.W/pc(kgs)	Q'ty/CTN
DL83-3-13W	13W	Ø110x80	Ø90-100	1160lm	0.33	30PCS
DL83-6-25W	25W	Ø190x100	Ø160-180	2620lm	0.76	12PCS
DL83-8-35W	35W	Ø230x110	Ø200-220	3700lm	0.98	12PCS

CCT



Finish



CL94 Downlight

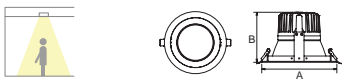

ELWA deep reflector UGR<19 downlight CL94, bring soft lighting for human eyes. It adopts brand CITIZEN COB which makes uniform light and excellent lumen output. CL94 is your priority selected product for commercial lighting.

Model	Watt	Size(AxBmm)	Cut-out(mm)	Lumen(±5)	N.W/pc(kgs)	Q'ty/CTN
CL94-3-13W	13W	Ø110x100	Ø95-100	920lm	0.38	24PCS
CL94-6-25W	25W	Ø190x127	Ø165-180	2550lm	0.85	12PCS
CL94-8-35W	35W	Ø230x140	Ø205-220	3350lm	1.2	12PCS

CCT

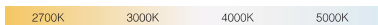

Finish

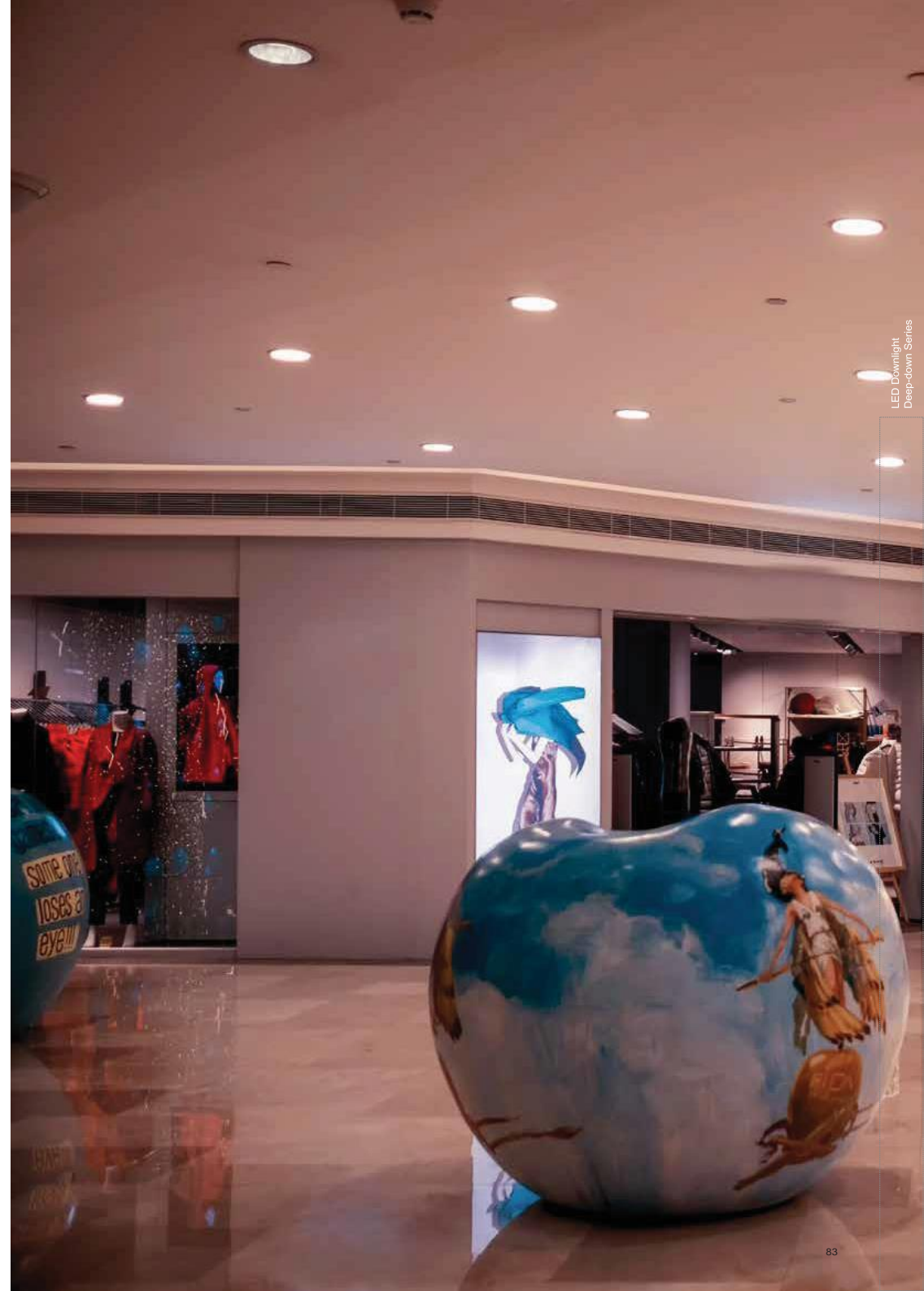

DL207 Downlight



DL207 is a surface mounted Downlight, the light direction can be adjusted with hemispherical rotation. Adopt brand CITIZEN COB makes uniform light and excellent lumen output; Non-dimmable and Triac dimmable are both available.

Model	Watt	Size(AxBmm)	Lumen(±5)	N.W/pc(kgs)	Q'ty/CTN
DL207-15W	15W	Ø85x186	1750lm	0.67	12PCS
DL207-25W	25W	Ø85x211	2900lm	0.73	12PCS

CCT



Finish



LED Downlight
 Surface mounted &
 Pendant Series

DL176 Downlight



DL176 down light with traditional deep reflector (UGR<19) that provides perfect combination of high lighting efficiency, comfortable lighting and humanization design, without compromising on light performance (color rendering and color uniformity); It offers a wide choice of options for creating the desired ambience.

Model	Watt	Size(AxBmm)	Lumen(±5)	N.W/pc(kgs)	Q'ty/CTN
DL176-15W	15W	Ø100.4x133.8	1750lm	0.65	18PCS
DL176-25W	25W	Ø120.4x143.8	2800lm	0.84	12PCS
DL176-35W	35W	Ø170x159	3900lm	1.45	6PCS

CCT



Finish



DL38 Downlight

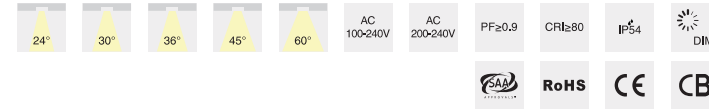

ELWA surfaced mounted downlight DL38 adopts brand CITIZEN COB, IP54 applicable for humid environment. AL6063 Aluminum body with oxidation treatment provides corrosion resistance and excellent heat dissipation performance. 10W/15W/25W/30W/32W/35W are available for your choice.

Model	Watt	Size(AxBmm)	Lumen(±5)	N.W/pc(kgs)	Q'ty/CTN
DL38-10W	10W	Ø90x100	890lm	0.52	24PCS
DL38-15W	15W	Ø90x100	1300lm	0.52	24PCS
DL38-25W	25W	Ø120x110	2420lm	0.75	12PCS
DL38-30W-DA	30W	Ø160x120	3500lm	1.5	12PCS
DL38-32W	32W	Ø160x120	3540lm	1.5	12PCS
DL38-35W	35W	Ø160x120	3450lm	1.5	12PCS

CCT



Finish



DL129 Downlight



Surface mounted downlight DL129 adopts brand CITIZEN COB and high reflective (more than 88%) reflector make sure the high luminous 105lm/W. Adjustable lighting direction: 350°in horizontal and 25°in vertical, 90mm/115mm diameter, 6W/10W/20W meet your demand.

Model	Watt	Size(AxAxBmm)	Lumen(±5)	N.W/pc(kgs)	Q'ty/CTN
DL129-90-6W	6W	90x90x110	630lm	0.6	24PCS
DL129-90-10W	10W	90x90x110	1030lm	0.6	24PCS
DL129-115-20W	20W	115x115x122	2350lm	0.9	18PCS

CCT



Finish



DL130 Downlight



Surface mounted downlight DL130 adopts brand CITIZEN COB and high reflective (more than 88%) reflector make sure the high luminous 105lm/W. Adjustable lighting direction: 350°in horizontal and 25°in vertical, 90mm/115mm diameter, 6W/10W/20W meet your demand.

Model	Watt	Size(AxBmm)	Lumen(±5)	N.W/pc(kgs)	Q'ty/CTN
DL130-90-6W	6W	Ø90x110	630lm	0.55	24PCS
DL130-90-10W	10W	Ø90x110	1030lm	0.55	24PCS
DL130-115-20W	20W	Ø115x122	2350lm	0.83	18PCS

CCT



Finish



DL160 Downlight

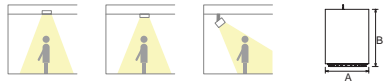

DL160 DIY module can be flexibly assembled into track light, surface mounted down light and recessed down light when match with different fixture. The module beam angle adjusted from 20° to 70° makes the light change very evenly.

Model	Watt	Size(AxBxCmm)	Lumen(±5)	N.W/pc(kgs)	Q'ty/CTN
DL160-25W	25W	Ø100x131.5	3250lm	0.98	18PCS
DL160-100-A	/	Ø100x66	/	0.35	36PCS
DL160-175-B	/	Ø175x48	/	0.35	24PCS
DL160-175-C	/	175x175x48	/	0.4	24PCS
UP-TL147-25W	/	Ø100x157x108	/	0.45	24PCS

CCT



Finish



DL160 DIY module



DL51 Downlight

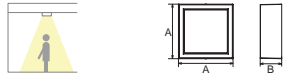

ELWA surface mounted ceiling light DL51 adopts dimmable design, PMMA diffuser with even light output. IP54 waterproof structural design, it is an ideal replacement for damp location.

Model	Watt	Size(AxAxBmm)	Lumen(±5)	N.W/pc(kgs)	Q'ty/CTN
DL51-8W	8W	100x100x59	696lm	0.35	30PCS
DL51-15W	15W	150x150x59	1365lm	0.57	24PCS
DL51-18W	18W	170x170x59	1692lm	0.71	24PCS

CCT



Finish



DL52 Downlight



ELWA surface mounted ceiling light DL52 adopts dimmable design, PMMA diffuser with even light output. IP54 waterproof structural design, it is an ideal replacement for damp location.

Model	Watt	Size(AxBmm)	Lumen(±5)	N.W/pc(kgs)	Q'ty/CTN
DL52-8W	8W	Ø100x60	744lm	0.35	30PCS
DL52-12W	12W	Ø150x68	1140lm	0.69	24PCS
DL52-15W	15W	Ø150x68	1380lm	0.69	24PCS
DL52-18W	18W	Ø170x68	1782lm	0.86	24PCS

CCT



Finish



DL115A/B Downlight



ELWA DL115A/B adopts simple and elegant design. Different beam angles are available in various reflectors. 3 UGR levels (19, 22, 25) are optional for multiple applications. IP54 for indoor use, dimmable and 3 CCT are available for choices. Surface mounted installation .

Model	Watt	Size(AxBmm)	Lumen(±5)	N.W/pc(kgs)	Q'ty/CTN
DL115-4-13W	13W	Ø143x112	1460lm	0.39	12PCS
DL115-6-18W	18W	Ø170x124	1890lm	0.49	12PCS
DL115-8-25W	25W	Ø213x129	2930lm	0.8	12PCS

CCT

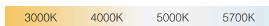

Finish



Re-Reflector



PD05A/B Downlight



ELWA PD05A/B adopts simple and elegant design. Different beam angles are available in various reflectors. 3 UGR levels (19, 22, 25) are optional for multiple applications. IP54 for indoor use, dimmable and 3 CCT are available for choices. Pendant installation.

Model	Watt	Size(AxBmm)	Lumen(±5)	N.W/pc(kgs)	Q'ty/CTN
PD05-4-13W	13W	Ø143x110	1460lm	0.65	12PCS
PD05-6-18W	18W	Ø170x123	1890lm	0.83	12PCS
PD05-8-25W	25W	Ø213x127	2930lm	1.06	12PCS

CCT

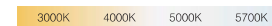

Finish

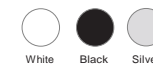

Re-Reflector



PD02A Downlight

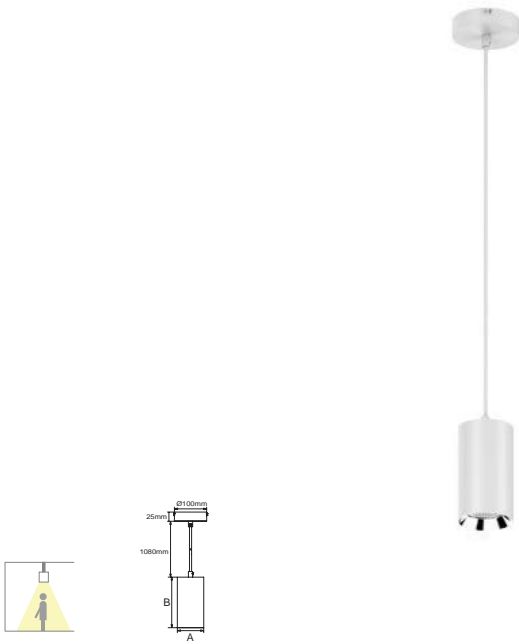
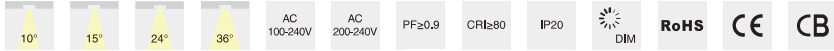

ELWA PD02A adopts straightforward design with stylish appearance, easy to install, simple and generous, paying more attention to leisure and comfort. Brand CREE COB, 10W/18W/25W are available for different demands.

Model	Watt	Size(AxBmm)	Lumen(±5)	N.W/pc(kgs)	Q'ty/CTN
PD02A-10W	10W	Ø80x130	900lm	0.75	24PCS
PD02A-18W	18W	Ø80x160	1660lm	0.81	24PCS
PD02A-25W	25W	Ø112.5x160	2765lm	0.95	24PCS

CCT

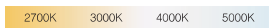

Finish

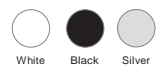

Decoration Ring



PD02B Downlight



ELWA PD02B adopts straightforward design with stylish appearance, easy to install, simple and generous, paying more attention to leisure and comfort. Brand CREE COB, 10W/18W/25W are available for different demands.

Model	Watt	Size(AxBmm)	Lumen(±5)	N.W/pc(kgs)	Q'ty/CTN
PD02B-10W	10W	Ø80x130	900lm	0.5	24PCS
PD02B-18W	18W	Ø80x160	1660lm	0.56	24PCS
PD02B-25W	25W	Ø112.5x160	2765lm	0.75	24PCS

CCT

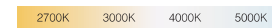

Finish

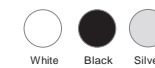

Decoration Ring



PD12 Downlight



ELWA PD12 pendant light adopts straightforward design with stylish appearance, giving space a clear and lively feeling. Different color of surface ring is optional, which could create diversified light atmosphere according to different environment.

Model	Watt	Size(AxBmm)	Lumen(±5)	N.W/pc(kgs)	Q'ty/CTN
PD12-5W	5W	Ø39x300	500lm	0.51	18PCS
PD12-5W	5W	Ø39x500	500lm	0.65	18PCS
PD12-10W	10W	Ø58x180	1000lm	0.54	12PCS

CCT



Finish



PD12B Downlight

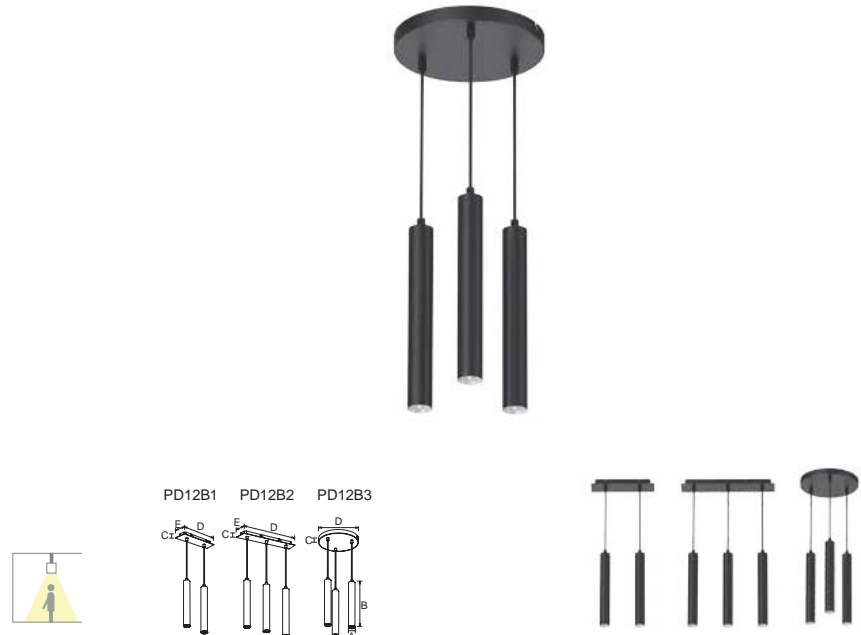

ELWA Cylinder LED PD12B adopts straightforward design with stylish appearance, paying more attention to leisure and comfort. It gives space a clear and lively feeling. Different color of surface ring is optional, creating diversified light atmosphere according to different environment.

Model	Watt	Size(AxBxCxDxEmm)	Lumen(±5)	N.W/pc(kgs)	Q'ty/CTN
PD12B1-10W	10W	Ø39x300x26x250x80	1100lm	1.2	6PCS
PD12B2-15W	15W	Ø39x300x26x370x80	1650lm	1.8	6PCS
PD12B3-15W	15W	Ø39x300x25xØ240	1650lm	1.8	6PCS

CCT



Finish



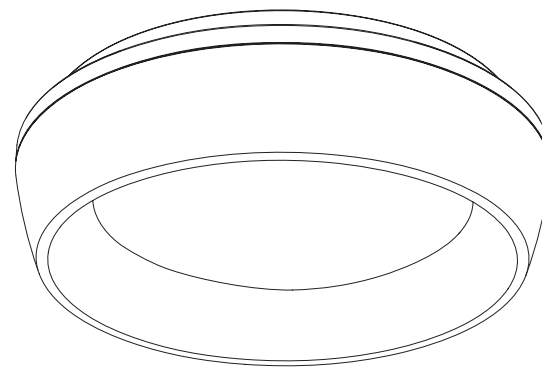

LED Ceiling Light /Series/

LED ceiling light in all its forms—most of the time plays a secondary role of attention but attaches great importance to the general lighting of a room. It puts your room in the best lighting effect by innovative lighting solutions and design. ELWAs ceiling light series has a low profile design providing a discreet, robust and stylish emergency, sensor and main luminaire. It's elegantly slim and offers as both emergency and mains luminaires. It allows the same seamless profile to be used throughout an installation. All options in the range are ideal for all projects when a high quality luminaire is required. Offering wide flexibility in facility lighting which is best suited to residential and commercial areas.

AL53 Ceiling light

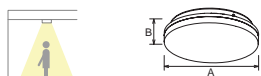

Frameless ceiling light is the market mainstream now, AL53 adopts high lumen SMD LED and fire-rated PC diffuser. IP54 waterproof structural design, it is applied to wet locations. Triac dimmable available.

Model	Watt	Size(AxBmm)	Lumen(±5)	N.W/pc(kgs)	Q'ty/CTN
AL53-10-12W	12W	Ø250x50	1265lm	0.7	20PCS
AL53-12-18W	18W	Ø300x58	1720lm	0.96	10PCS
AL53-12-25W	25W	Ø300x58	2430lm	0.96	10PCS
AL53-16-25W	25W	Ø400x63	2490lm	1.66	10PCS
AL53-16-30W	30W	Ø400x63	2980lm	1.66	10PCS

CCT



Finish



AL54 Ceiling light

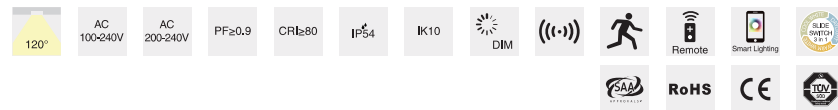

Square surface mounted ceiling light adopts high lumen SMD LED and fire-rated PC diffuser. IP54 waterproof structural design, it is applied to wet locations. Triac dimmable available.

Model	Watt	Size(AxAxBmm)	Lumen(±5)	N.W/pc(kgs)	Q'ty/CTN
AL54-10-12W	12W	250x250x50	1320lm	0.8	20PCS
AL54-12-18W	18W	300x300x58	1960lm	1.12	10PCS
AL54-12-25W	25W	300x300x58	2640lm	1.12	10PCS
AL54-16-25W	25W	400x400x63	2635lm	1.84	10PCS
AL54-16-30W	30W	400x400x63	3160lm	1.84	10PCS

CCT



Finish



AL08 Ceiling light

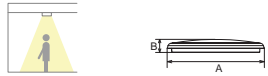

AL08 series ceiling light is with IP54 waterproof design, 8/10/12/14/16 inch sizes as options, and with emergency, sensor, 3CCT changeable (by slide switch or remote control), triac dimmable functions etc. CE RoHS SAA TUV certificates are all available.

Model	Watt	Size(AxBmm)	Lumen(±5)	N.W/pc(kgs)	Q'ty/CTN
AL08-8-12W	12W	Ø200x48	1260lm	0.42	20PCS
AL08-10-12W	12W	Ø250x48	1068lm	0.66	10PCS
AL08-12-18W	18W	Ø300x40	1910lm	0.8	10PCS
AL08-12-25W	25W	Ø300x40	2180lm	0.8	10PCS
AL08-12-30W	30W	Ø300x40	3090lm	0.8	10PCS
AL08-14-25W	25W	Ø350x40	2575lm	1.3	10PCS
AL08-16-30W	30W	Ø400x52	3090lm	1.4	10PCS

CCT



Finish



AL12 Ceiling light

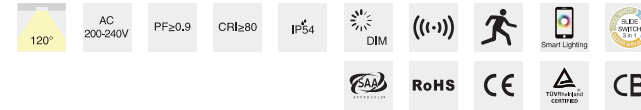

Square version of AL12 ceiling light, super slim and high lumen output. It's ideal and suited to any indoor applications, including bathrooms and kitchens etc.

Model	Watt	Size(AxAxBmm)	Lumen(±5)	N.W/pc(kgs)	Q'ty/CTN
AL12-10-12W	12W	250x250x50	1330lm	0.75	20PCS
AL12-12-18W	18W	300x300x40	1995lm	0.96	10PCS
AL12-12-25W	25W	300x300x40	2160lm	0.96	10PCS
AL12-14-25W	25W	350x350x41	2775lm	1.24	10PCS
AL12-16-30W	30W	400x400x51	3330lm	2	10PCS

CCT



Finish



AL37 Ceiling light



Super slim motion sensor ceiling light, total height less than 33mm, which makes this round ceiling light look more gorgeous and easier in installation. Low UGR ceiling mount motion sensor light is not only protecting our eyes, but also making attention more concentrated.

Model	Watt	Size(AxBmm)	Lumen(±5)	N.W/pc(kgs)	Q'ty/CTN
AL37-10-12W	12W	Ø250x33	1520lm	0.54	20PCS
AL37-12-15W	15W	Ø300x33	2000lm	0.8	10PCS
AL37-16-25W	25W	Ø400x33	3120lm	1.33	10PCS

CCT



Finish



AL38 Ceiling light



Square version of AL38 ceiling light. Equipped with fast connection terminal. Installation could be completed easily by rotating lamp fixture to the fixed bracket. It is suitable for commercial and residential applications.

Model	Watt	Size(AxAxBmm)	Lumen(±5)	N.W/pc(kgs)	Q'ty/CTN
AL38-10-12W	12W	250x250x33	1560lm	0.66	20PCS
AL38-12-15W	15W	300x300x33	1890lm	0.9	10PCS
AL38-16-25W	25W	400x400x33	3050lm	1.58	10PCS

CCT



Finish



AL85 Ceiling light



AL85 is an integrated slim design ceiling light with high luminous flux. Waterproof function(IP54) expand the application area. Presser device makes the installation easier. Triac dimmable, Color switchable combines dimmable both available.

Model	Watt	Size(AxBmm)	Lumen(±5)	N.W/pc(kgs)	Q'ty/CTN
AL85-10-12W	12W	Ø250x64	1060lm	0.5	20PCS
AL85-12-15W	15W	Ø300x66.5	1820lm	0.7	10PCS
AL85-16-25W	25W	Ø400x69	2600lm	1.14	10PCS

CCT



Finish



AL87 Ceiling light



AL87 is a new frameless ceiling light with user-friendly design ideal of both opening wiring and concealed wiring, easy and fast installation is expectable. Multiple size, wattage and function optional.

Model	Watt	Size(AxBmm)	Lumen(±5)	N.W/pc(kgs)	Q'ty/CTN
AL87-11-12W	12W	Ø275x65	1320lm	0.7	12PCS
AL87-11-18W	18W	Ø275x65	2100lm	0.7	12PCS
AL87-11-25W	25W	Ø275x65	2800lm	0.7	12PCS
AL87-14-25W	25W	Ø350x65	2800lm	1	6PCS
AL87-14-30W	25W	Ø350x65	3400lm	1	6PCS

CCT



Finish



AL24A Ceiling light



Hollow shape modern ceiling light fixtures could bring vitality into ordinary ceiling mount light fixture body and shows faultless performance. The curved light direction emphasizes target object of a smooth and dramatic atmosphere.

Model	Watt	Size(AxBmm)	Lumen(±5)	N.W/pc(kgs)	Q'ty/CTN
AL24A-12-18W	18W	Ø298x51	1450lm	1.08	10PCS
AL24A-12-25W	25W	Ø298x51	2000lm	1.08	10PCS
AL24A-16-35W	35W	Ø400x68	3100lm	1.89	6PCS

CCT



Finish



AL24B Ceiling light

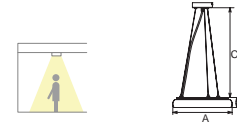
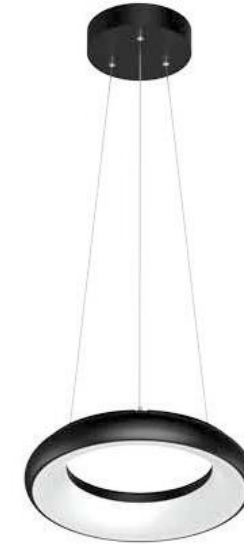

Hollow shape modern ceiling light fixtures could bring vitality into ordinary ceiling mount light fixture body and shows faultless performance. The curved light direction emphasizes target object of a smooth and dramatic atmosphere.

Model	Watt	Size(AxBxCmm)	Lumen(±5)	N.W/pc(kgs)	Q'ty/CTN
AL24B-12-18W	18W	Ø298x50x1450	1450lm	0.87	10PCS
AL24B-12-25W	25W	Ø298x50x1450	2000lm	0.87	10PCS
AL24B-16-35W	35W	Ø400x67x1450	3100lm	1.55	6PCS

CCT



Finish



AL41A Ceiling light

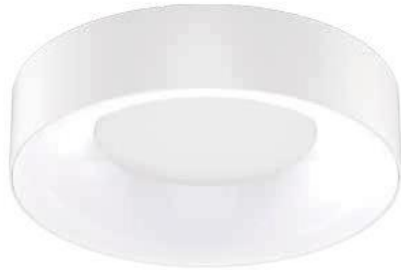

AL41 ceiling light (full PC) adopts elegant and concave design, which makes the luminous surface compact and with magic 3D effects. Surface mounted and suspended installation are also optional, equipped with rotating lamp fixture, makes the surface mounted installation much easier.

Model	Watt	Size(AxBmm)	Lumen(±5)	N.W/pc(kgs)	Q'ty/CTN
AL41A-12-18W	18W	Ø300x71	1710lm	1.04	6PCS
AL41A-16-25W	25W	Ø400x71	2370lm	1.53	6PCS

CCT



Finish



AL41B Ceiling light

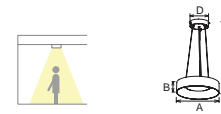

AL41 ceiling light (full PC) adopts elegant and concave design, which makes the luminous surface compact and with magic 3D effects. Surface mounted and suspended installation are also optional, equipped with rotating lamp fixture, makes the surface mounted installation much easier.

Model	Watt	Size(AxBxCxDmm)	Lumen(±5)	N.W/pc(kgs)	Q'ty/CTN
AL41B-12-18W	18W	Ø300x71x1200x100	1710lm	1.53	4PCS
AL41B-16-25W	25W	Ø400x71x1200x100	2370lm	1.86	4PCS

CCT



Finish



AL47 Ceiling light

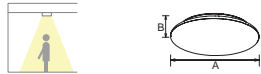

Flying saucer-shaped led ceiling light, super slim. It is a faultless combination and deduction of smooth lines, making itself fit with ceiling perfectly. Elegant design realizes a perfect blend of craft and art.

Model	Watt	Size(AxBmm)	Lumen(±5)	N.W/pc(kgs)	Q'ty/CTN
AL47-10-12W	12W	Ø200x53	1200lm	0.53	20PCS
AL47-12-18W	18W	Ø300x58	1900lm	0.76	10PCS
AL47-12-25W	25W	Ø300x58	2560lm	0.76	10PCS
AL47-16-25W	25W	Ø400x66	2550lm	1.31	10PCS
AL47-16-30W	30W	Ø400x66	3020lm	1.31	10PCS

CCT



Finish



AL47S Ceiling light



Square led ceiling light, super slim; it is a faultless combination and deduction of smooth lines, making itself fit with ceiling perfectly. Elegant design realizes a perfect blend of craft and art.

Model	Watt	Size(AxAxBmm)	Lumen(±5)	N.W/pc(kgs)	Q'ty/CTN
AL47S-12-18W	18W	300x300x58	1920lm	0.96	10PCS
AL47S-12-25W	25W	300x300x58	2670lm	0.96	10PCS
AL47S-16-25W	25W	400x400x58	2610lm	1.66	10PCS
AL47S-16-30W	30W	400x400x58	3160lm	1.66	10PCS

CCT



Finish



AL25 Ceiling light



AL25 is frameless and surface mounted design. Its lamp body and diffuser adopts high quality PC which is UL94-V0 fire resistant. IK08 impact resistant, separated galvanized steel mounting bracket makes it achieve easier installation.

Model	Watt	Size(AxBmm)	Lumen(±5)	N.W/pc(kgs)	Q'ty/CTN
AL25-10-12W	12W	Ø250x48	1190lm	0.73	20PCS
AL25-12-18W	18W	Ø300x48	1720lm	0.88	10PCS
AL25-16-25W	25W	Ø400x62.8	2350lm	1.75	10PCS

CCT



Finish



AL45 Ceiling light

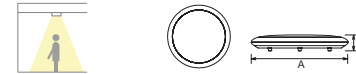
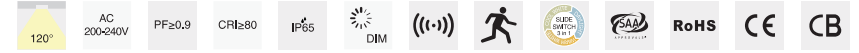

AL45 is a module design surface mount luminaire, it's with fire rated PC material, IP65 waterproof and IK10 impact resistant, dimmable, sensor, emergency version and various of sizes are available for this product.

Model	Watt	Size(AxBmm)	Lumen(±5)	N.W/pc(kgs)	Q'ty/CTN
AL45-10-12W	12W	Ø270x70	1280lm	0.755	10PCS
AL45-12-18W	18W	Ø320x70	1940lm	0.995	6PCS
AL45-12-25W	25W	Ø320x70	2700lm	0.995	6PCS
AL45-16-25W	25W	Ø420x85	2650lm	1.59	6PCS
AL45-16-30W	30W	Ø420x85	3150lm	1.59	6PCS
AL45-20-30W	30W	Ø520x85	3180lm	2.4	6PCS
AL45-20-35W	35W	Ø520x85	3670lm	2.4	6PCS
AL45-20-40W	40W	Ø520x85	4160lm	2.4	6PCS

CCT



Finish



AL02A Ceiling light



AL02A is a mushroom shape ceiling light, made of aluminum base and PS diffuser. Multiple functions available for triac dimmable, sensor and CCT changeable and dimmable via 2.4G intelligent remote control.

Model	Watt	Size(AxBmm)	Lumen(±5)	N.W/pc(kgs)	Q'ty/CTN
AL02A-11-15W	15W	Ø275x100	1250lm	0.76	5PCS
AL02A-14-25W	25W	Ø350x110	2120lm	1.1	5PCS

CCT



Finish



AL02B Ceiling light

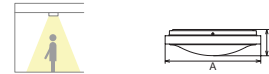

AL02B is a mushroom shape ceiling light, made of aluminum base and PS diffuser. Multiple functions available for triac dimmable, sensor and CCT changeable and dimmable via 2.4G intelligent remote control.

Model	Watt	Size(AxBmm)	Lumen(±5)	N.W/pc(kgs)	Q'ty/CTN
AL02B-11-15W	15W	Ø300x86	1150lm	0.92	5PCS
AL02B-14-25W	25W	Ø350x96	1680lm	1.29	5PCS

CCT



Finish



AL51 Ceiling light



AL51 is a Tri-CCT changeable ceiling light with PC diffuser and aluminum base, CCT is adjusted via a switch on the back of the lamp, 350mm and 380mm, 350mm available. It also comes with emergency function.

Model	Watt	Size(AxBmm)	Lumen(±5)	N.W/pc(kgs)	Q'ty/CTN
AL51-14-16W	16W	Ø350x106	1570lm	0.635	5PCS
AL51-15-25W	25W	Ø380x120	2500lm	0.74	5PCS

CCT



Finish



AL52 Ceiling light

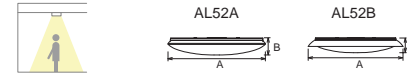

AL52 is a big Tri-CCT changeable and dimmable ceiling light by 2.4G intelligent remote controller, 600mm diameter body with additional reflector which extend 70mm bigger on dimension, IP20 for indoor use.

Model	Watt	Size(AxBmm)	Lumen(±5)	N.W/pc(kgs)	Q'ty/CTN
AL52A-45W	45W	Ø600x106	3735lm	2.5	1PCS
AL52B-45W	45W	Ø670x106	3735lm	2.8	1PCS

CCT



Finish



AL71 Ceiling light



AL71 is a new design IP54 grade ceiling light, which be with replaceable module design for fast installation, fire-rated PC diffuser, ensure safety performance. Triac dimmable available.

Model	Watt	Size(AxBmm)	Lumen(±5)	N.W/pc(kgs)	Q'ty/CTN
AL71-10-12W	15W	Ø300x105	1570lm	1.1	4PCS

CCT



Finish



AL55 Ceiling light

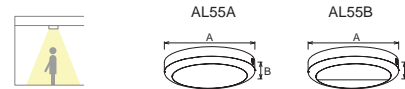

AL55 is a ceiling light which comes with multifunction, triac dimmable, emergency, sensor, color switchable, wattage switchable. Its cover can be circular and semi-circular diffuser to create different lighting effect, IP54 and IP65 optional.

Model	Watt	Size(AxBmm)	Lumen(±5)	N.W/pc(kgs)	Q'ty/CTN
AL55-12-15W	15W	Ø300x60	1480lm	0.96	6PCS

CCT



Finish



AL42 Ceiling light



AL42 is an anti-glare DIY ceiling light which with unique, compact and elegant design. It can be installed optionally into different shapes and images with available different frame color such as red, green, gray.

Model	Watt	Size(AxAxBmm)	Lumen(±5)	N.W/pc(kgs)	Q'ty/CTN
AL42-6-12W	12W	160x160x62	940lm	0.56	24PCS

CCT



Finish



AL48 Ceiling light

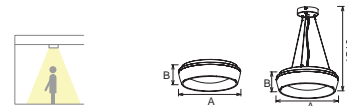

AL48 is a luxurious decorative ceiling light which with faceted transparent cover, Tri-CCT changeable and dimmable function. Surface mount and pendant install available.

Model	Watt	Size(AxBmm)	Lumen(±5)	N.W/pc(kgs)	Q'ty/CTN
AL48-12-18W	18W	Ø300x87.5	1750lm	1.32	5PCS

CCT



Finish



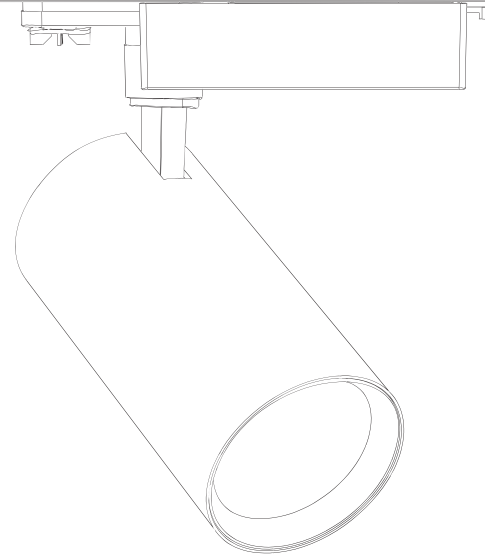

LED Track Light /Series/

LED track light has been around for decades, yet it remains as fresh and contemporary a ceiling light fixture as ever. This is due primarily to its pure modern look, with clean, rigid tracks and streamlined directional heads. But function is also a factor when it comes to a track lighting system, with each of the selected track heads independently and easily adjustable and brightly focused. Complete track lighting kits will also allow you to have a stylish ceiling track lighting system instantly. ELWA's various track lights could be your next excellent choice!



TL29A/C



TL29B/D



TL29E



TL29F

TL29 Track Light /Series/

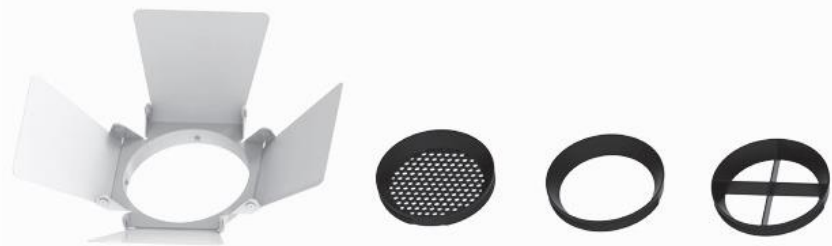



2019
STD
Specifications

TL29A Track light

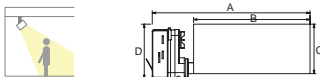

ELWA driverless track light adopts high quality brand DOB led light source, supreme 6063 aluminum, anti-glare PMMA lens and interchangeable reflectors and trim, creating a diversified and dramatic atmosphere for targeted objects in different accent lighting situations.

Model	Watt	Size(AxBxCxDmm)	Lumen(±5)	N.W/pc(kgs)	Q'ty/CTN
TL29A-20W	20W	261x170xØ85x93	1560lm	0.55	12PCS
TL29A-30W	30W	291x200xØ100x108	2550lm	0.79	12PCS
TL29A-40W	40W	291x200xØ100x108	3400lm	0.79	12PCS

CCT

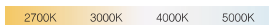

Finish



Trims Accessories



2019
PRO
Specifications

TL29B Track light

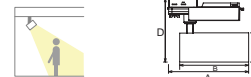

ELWA track light adopts brand Citizen cob led light source, supreme 6063 aluminum, anti-glare PMMA lens and interchangeable reflectors and trim.

Model	Watt	Size(AxBxCxDmm)	Lumen(±5)	N.W/pc(kgs)	Q'ty/CTN
TL29B-12W	12W	202x150xØ65x188	1200lm	0.52	12PCS
TL29B-25W	25W	202x170xØ85x206	2750lm	0.75	12PCS
TL29B-35W	35W	232x200xØ85x206	3675lm	0.79	12PCS
TL29B-42W	42W	232x200xØ100x220	4410lm	1.05	12PCS

CCT

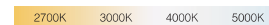

Finish

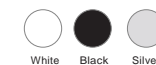

Trims Accessories





TL29C Track light

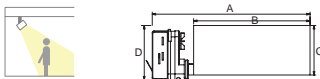

It adopts brand Citizen COB , Supreme 6063 aluminum heat sink and anti-glare PMMA lens achieving high quality, great heat dissipation and lighting distribution. Standard, honeycomb, shutter different trims for option.

Model	Watt	Size(AxBxCxDmm)	Lumen(±5)	N.W/pc(kgs)	Q'ty/CTN
TL29C-12W	12W	243x150xØ65x84	1200lm	0.47	12PCS
TL29C-25W	25W	291x200xØ85x93	2750lm	0.68	12PCS
TL29C-35W	35W	291x200xØ100x108	3675lm	0.79	12PCS

CCT

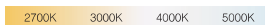

Finish



Trims Accessories



TL29D Track light

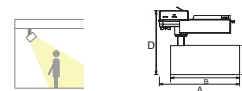

ELWA track light adopts brand SMD LED light source, supreme 6063 aluminum heat sink, anti-glare PC lens, simple design structure and 4 types reflectors and trim for option.

Model	Watt	Size(AxBxCxDmm)	Lumen(±5)	N.W/pc(kgs)	Q'ty/CTN
TL29D-20W-C3	20W	202x170xØ85x206	1800lm	0.75	12PCS
TL29D-30W-C3	30W	232x200xØ85x206	2600lm	0.79	12PCS

CCT



Finish

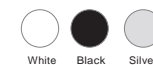

Trims Accessories





2019
PRO
Specifications

TL29E Track light



It adopts interchangeable reflectors and trim, changeable lighting orientation with 350° in horizontal direction and 90° in vertical direction and integrated design of driver and adapter.

Model	Watt	Size(AxBxCxDmm)	Lumen(±5)	N.W/pc(kgs)	Q'ty/CTN
TL29E-25W	25W	258x170xØ85x198	2750lm	0.65	12PCS
TL29E-35W	35W	288x200xØ85x198	3675lm	0.68	12PCS

CCT

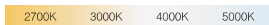

Finish

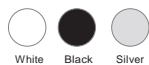

Trims Accessories



2019
PRO
Specifications

TL29F Track light



ELWA track light with Tridonic DALI driver adopts brand Citizen cob led light source, supreme 6063 aluminum, PC lens and interchangeable reflectors and trim.

Model	Watt	Size(AxBxCxDmm)	Lumen(±5)	N.W/pc(kgs)	Q'ty/CTN
TL29F-25W	25W	298x170xØ85x198	2610lm	0.9	12PCS
TL29F-35W	35W	328x200xØ85x198	3490lm	0.95	12PCS
TL29F-42W	42W	328x200xØ100x198	4110lm	1.2	12PCS

CCT

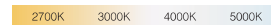

Finish

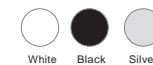

Trims Accessories





TL57 Track light



It is with internal driver, ADC12 die-casting Aluminum body for good heat dissipation, Secondary optics with lens and reflector make more uniform light. It adopts CITIZEN COB with high efficiency as 110lm/w and CRI80 /CRI90/CRI97 available. Adjustable lighting orientation with 350° in horizontal direction and 90° in vertical direction with bring a flexible exposure.

Model	Watt	Size(AxBxCxDmm)	Lumen(±5)	N.W/pc(kgs)	Q'ty/CTN
TL57-15W	15W	223x127xØ65x84.5	1750lm	0.49	12PCS
TL57-25W	25W	254x157xØ80x84.5	2850lm	0.79	12PCS
TL57-35W	35W	259x167xØ100x84.5	4000lm	1.03	12PCS

CCT



Finish



TL58 Track light



It is with internal driver, ADC12 die-casting Aluminum body for good heat dissipation, Secondary optics with lens makes more uniform light. It adopts CITIZEN COB with high efficiency as 110lm/w and CRI80 /CRI90/CRI97 available. Adjustable lighting orientation with 350° in horizontal direction and 90° in vertical direction with bring a flexible exposure.

Model	Watt	Size(AxBxCxDmm)	Lumen(±5)	N.W/pc(kgs)	Q'ty/CTN
TL58-15W	15W	227x131xØ65x84.5	1650lm	0.52	12PCS
TL58-25W	25W	249x152.5xØ80x84.5	2750lm	0.82	12PCS
TL58-35W	35W	259x167xØ100x84.5	3850lm	1.1	12PCS

CCT



Finish





TL40A Track light

TL40A unique design track light adopts brand CREE chip and supreme Aluminum heat sink. It is with interchangeable diffuser to reach eight different beam angle that helps to expand the application range.

Model	Watt	Size(AxBxCxDmm)	Lumen(±5)	N.W/pc(kgs)	Q'ty/CTN
TL40A-7W	7W	230xØ54x90x156	550lm	0.45	24PCS
TL40A-10W	10W	230xØ54x90x156	740lm	0.45	24PCS

CCT

3000K 4000K 5000K 5700K

Finish

White Black Silver



TL40B Track light

TL40B is a new design track light adopts Citizen chip, high quality LED source and supreme Aluminum heat sink to create a diversified and dramatic atmosphere.

Model	Watt	Size(AxBxCxDmm)	Lumen(±5)	N.W/pc(kgs)	Q'ty/CTN
TL40B-10W	10W	236xØ54x90x162	1000lm	0.45	24PCS
TL40B-12W	12W	236xØ54x90x162	1200lm	0.45	24PCS

CCT

2700K 3000K 4000K 5000K

Finish

White Black Silver



TL25 Track light

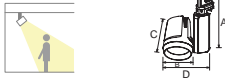

It's adopts Citizen LED, adjustable lighting orientation with 360 degree in horizontal direction and 180 in vertical direction and 1-circuit adapter, 3-circuit adapter available for wide choice.

Model	Watt	Size(AxBxCxDmm)	Lumen(±5)	N.W/pc(kgs)	Q'ty/CTN
TL25-15W	15W	170xØ83x68x102	1470lm	0.38	18PCS
TL25-25W	25W	215xØ118.5x90x146	2600lm	0.68	12PCS
TL25-35W	35W	215xØ128x105x161	3600lm	0.85	12PCS
TL25-45W	45W	215xØ128x105x161	4410lm	0.85	12PCS

CCT

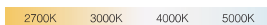

Finish



Dimming button (100% down to 5%)



TL25B Track light



It's adopts Citizen LED, adjustable lighting orientation with 360 degree in horizontal direction and 180 in vertical direction and 1-circuit adapter, 3-circuit adapter available for wide choice.

Model	Watt	Size(AxBxCxDmm)	Lumen(±5)	N.W/pc(kgs)	Q'ty/CTN
TL02B-25W	25W	247xØ90x118x207	2600lm	0.75	12PCS
TL02B-35W	35W	262xØ105x128x207	3600lm	0.92	12PCS
TL02B-45W	45W	262xØ105x128x207	4410lm	0.92	12PCS

CCT

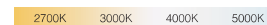

Finish

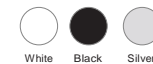



TL02 Track light

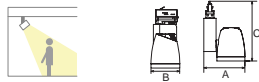

It's a very popular full family traditional track spot. 12W, 25W, 35W, 45W are all available. Branded CREE / CITIZEN led chips provide super soft light output.

Model	Watt	Size(AxBxCmm)	Lumen(±5)	N.W/pc(kgs)	Q'ty/CTN
TL02-12W	12W	126.5x89x220	1380lm	0.7	12PCS
TL02-25W	25W	141x91x233	2500lm	1.17	12PCS
TL02-35W	35W	161x110x234	3600lm	1.3	8PCS
TL02-45W	45W	161x110x234	4380lm	1.3	8PCS

CCT

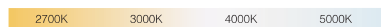

Finish



TL16 Track light

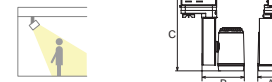

ELWA patented mini track lights adopts brand CITIZEN COB. Color changeable and triac dimmable are both available that can be compatible with global brand dimmer.

Model	Watt	Size(AxBxCmm)	Lumen(±5)	N.W/pc(kgs)	Q'ty/CTN
TL16-12W	12W	Ø62x100x182	1350lm	0.46	20PCS

CCT



Finish





TL45 Track light

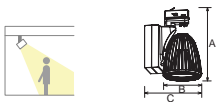

ELWA LED track light with built-in, flicker-free driver adopts aluminum heat sink, interchangeable reflector design, high lumen CITIZEN LEDs. Providing excellent heat dissipation, even light output without glare & dark spot.

Model	Watt	Size(AxBxCmm)	Lumen(±5)	N.W/pc(kgs)	Q'ty/CTN
TL45-40W	40W	248xØ132.5x189.5	4080lm	1.45	8PCS
TL45-50W	50W	248xØ132.5x189.5	5000lm	1.45	8PCS

CCT



Finish



TL17 Track light



With an adjustable beam angle, TL17 LED track light plays a leading role in adopting a manual zoom stretch head. One track light with flexible beam angle varies from 10°-60°, creating a diversified and dramatic atmosphere for targeted objects in different accent lighting situations.

Model	Watt	Size(AxBmm)	Lumen(±5)	N.W/pc(kgs)	Q'ty/CTN
TL17-35W	35W	Ø100x301	1790-3720lm	1.53	6PCS

CCT



Finish





TL26B Track light

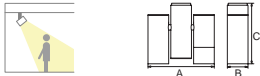

It's adopts Citizen LED, 15°/24°/36°/60° beam angle, adjustable lighting orientation with 360 degree in horizontal direction and 180 in vertical direction and 1-circuit adapter, 3-circuit adapter available for wide choice.

Model	Watt	Size(AxBxCmm)	Lumen(±5)	N.W/pc(kgs)	Q'ty/CTN
TL26B-10W	10W	122xØ58x170	750lm	0.62	30PCS
TL26B-20W	20W	186xØ58x170	1500lm	0.9	20PCS

CCT



Finish



TL50/-B Track light



This linear track light with concise design adopts 6063 aluminum, slide switch for interchangeable CCT and high lumen efficiency, 105lm/W.

Model	Watt	Size(AxBxCxDmm)	Lumen(±5)	N.W/pc(kgs)	Q'ty/CTN
TL50/-B-10W	10W	650x32.5x52x436	1000lm	0.43	12PCS
TL50/-B-16W	16W	650x32.5x52x436	1560lm	0.45	12PCS
TL50/-B-25W	25W	1212x32.5x52x496	2550lm	0.76	12PCS
TL50/-B-30W	30W	1212x32.5x52x496	3000lm	0.76	12PCS
TL50/-B-30W	30W	1493x32.5x52x496	3000lm	0.92	12PCS

CCT

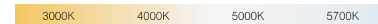

Finish





TL04 Track light

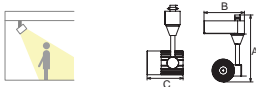

ELWA LED track light adopts high efficient reflector and COB LED chip with advanced light distribution technology without glare and maximum utilization of light output. Dimmable available and surface mounted and embedded installation optional.

Model	Watt	Size(AxBxCmm)	Lumen(±5)	N.W/pc(kgs)	Q'ty/CTN
TL04-10W	10W	162x102X85	1040lm	0.31	30PCS

CCT

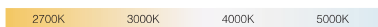

Finish



TL04B Track light

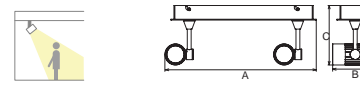

ELWA LED track light adopts high efficient reflector and COB LED chip with advanced light distribution technology without glare and maximum utilization of light output. Dimmable available and surface mounted and embedded installation optional.

Model	Watt	Size(AxBxCmm)	Lumen(±5)	N.W/pc(kgs)	Q'ty/CTN
TL04B-10W	10W	111x107x156	1040lm	0.5	20PCS
TL04B-2x10W	20W	395x107x156	2080lm	1.2	8PCS
TL04B-3x10W	30W	625x107x156	3120lm	1.8	6PCS
TL04B-4x10W	40W	855x107x156	4160lm	2.4	4PCS
TL04B-4x10W(S)	40W	295x291x156	4160lm	2.1	4PCS

CCT



Finish





TL13/B Track light

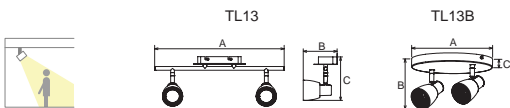
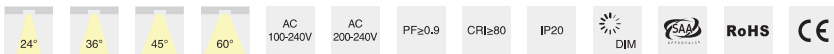

It adopts die-casting ADC12, high efficient COB led chip and adjustable lighting orientation with 350 degree in horizontal direction and 35 in vertical direction provided. Lamp with easy surface mounted installation.

Model	Watt	Size(AxBxCmm)	Lumen(±5)	N.W/pc(kgs)	Q'ty/CTN
TL13-10W	10W	204x117.5x148	800lm	0.7	12PCS
TL13-20W	20W	449x117.5x148	1600lm	1	6PCS
TL13-30W	30W	774x117.5x148	2400lm	1.3	6PCS
TL13B-10W	10W	Ø80x161x25	800lm	0.32	24PCS
TL13B-20W	20W	Ø240x161x25	1600lm	0.93	12PCS
TL13B-30W	30W	Ø240x161x25	2400lm	1.16	12PCS

CCT



Finish

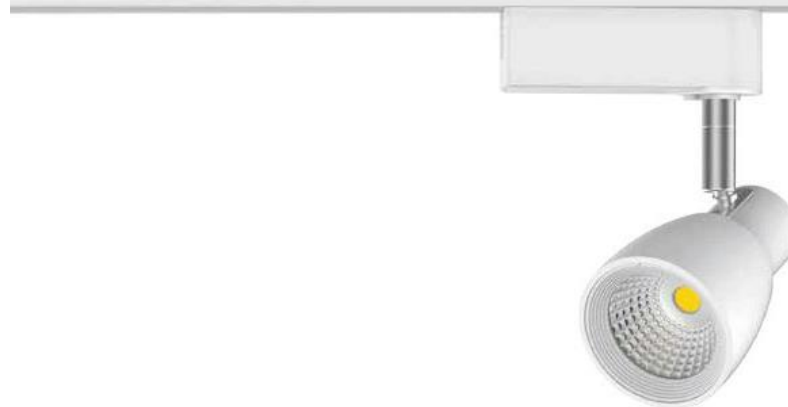

TL14 Track light



ELWA ceiling spotlight adopts die-casting ADC12, high efficient COB led chip and high transmittance glass to achieve excellent heat dissipation, high center luminous and maximum utilization of light output.

Model	Watt	Size(AxBxCmm)	Lumen(±5)	N.W/pc(kgs)	Q'ty/CTN
TL14-10W	10W	102x97.5x145	800lm	0.3	36PCS

CCT



Finish





TL19A-10W

TL19A-20W

TL19A-30W



TL19B-10W

TL19B-20W

TL19B-30W



TL19 Track light



TL19A

TL19B

TL19C

TL19D



ELWA ceiling spotlight adopts die-casting ADC12, high efficient COB led chip and transmittance optical lens to assure excellent heat dissipation, high center luminous intensity, maximum utilization of light output. Dimmable available, compatible with a wide range of recommended Triac dimmers and Surface mounted, track adaptor and recessed installations to meet different demands.

Model	Watt	Size(AxBxCmm)	Lumen(±5)	N.W/pc(kgs)	Q'ty/CTN
TL19A-10W	10W	Ø80x25x158	1055lm	0.28	24PCS
TL19A-20W	20W	Ø240x25x158	2110lm	0.84	12PCS
TL19A-30W	30W	Ø240x25x158	3165lm	1.02	12PCS
TL19B-10W	10W	140x80x160	1055lm	0.48	24PCS
TL19B-20W	20W	250x80x160	2110lm	0.9	12PCS
TL19B-30W	30W	370x80x160	3165lm	1.28	12PCS
TL19C-10W	10W	78x78x167	1055lm	0.28	24PCS
TL19D-10W	10W	85x32x175	1055lm	0.28	24PCS

CCT

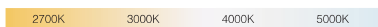

Finish



TL19A

TL19B

TL19C

TL19D



TL21 Track light

15° 24° 36° 60°
AC 100-240V AC 200-240V
PF≥0.9 CRI≥80 IP20
DIM SAA RoHS CE

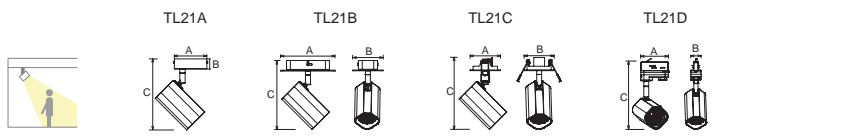

It is designed in combination of square and circular, perfectly integrated into different lighting applications. With high light efficiency, deep cylinder design for light outlet. Modularization design facilitates replacing universal head connection elements, which realizes diversified installation ways in one lamp.

Model	Watt	Size(AxBxCmm)	Lumen(±5)	N.W/pc(kgs)	Q'ty/CTN
TL21A-10W	10W	Ø80x25x175	805lm	0.28	24PCS
TL21A-20W	20W	Ø240x25x175	1610lm	0.84	12PCS
TL21A-30W	30W	Ø240x25x175	2415lm	1.02	12PCS
TL21B-10W	10W	140x80x177	805lm	0.52	24PCS
TL21B-20W	20W	250x80x177	1610lm	1.3	12PCS
TL21B-30W	30W	370x80x176	2415lm	2.05	12PCS
TL21B-40W	40W	505x80x176	3220lm	2.32	8PCS
TL21C-10W	10W	78x78x179	805lm	0.32	24PCS
TL21D-10W	10W	85x32x205	805lm	0.32	24PCS

CCT

2700K 3000K 4000K 5000K

Finish

White Black Silver



TL21A TL21B TL21C TL21D

Track System

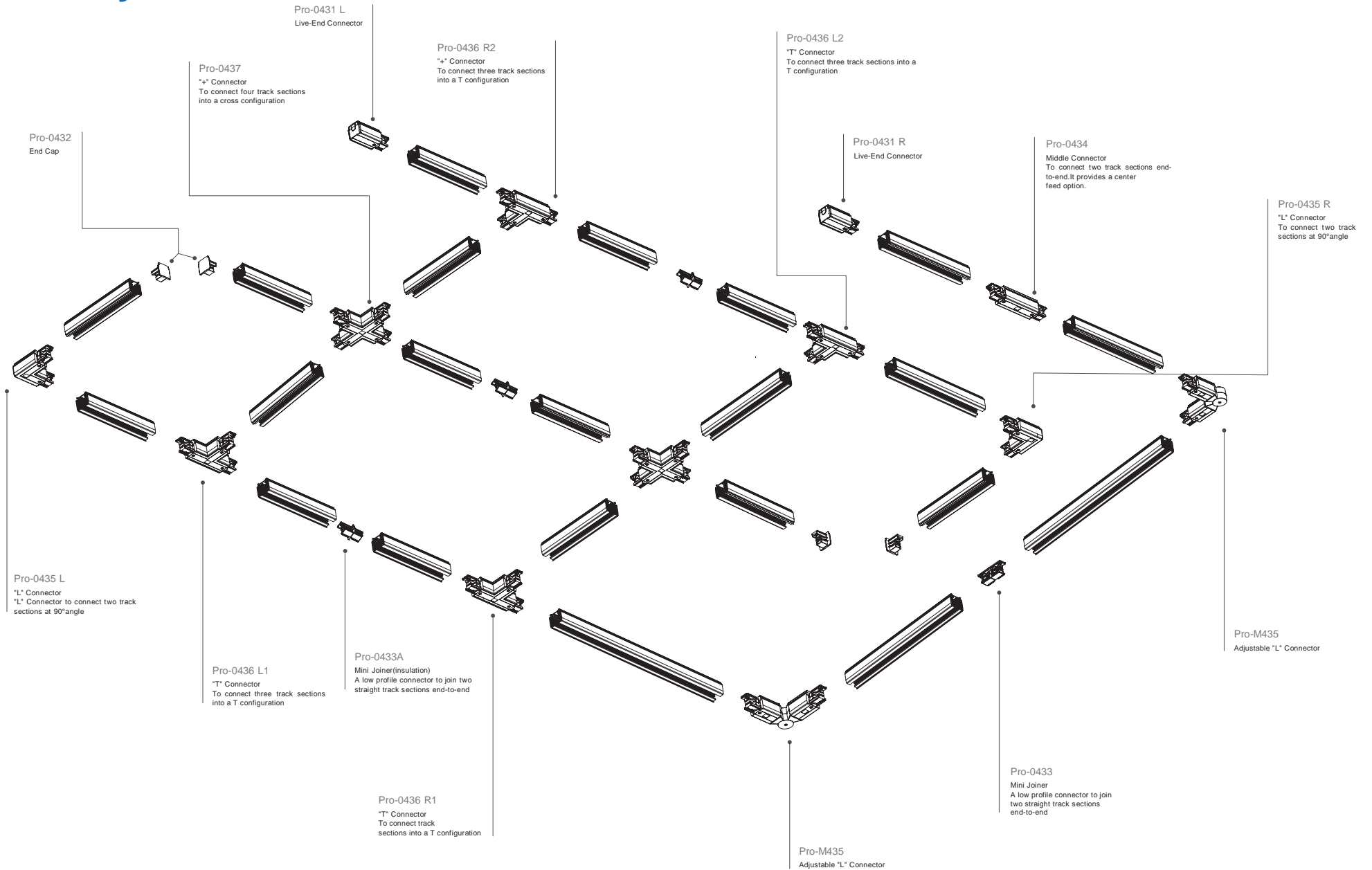

LED Track light

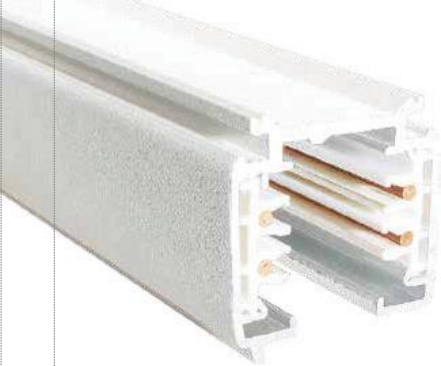

3 Circuits Track System

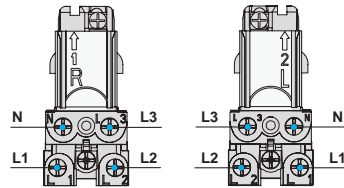
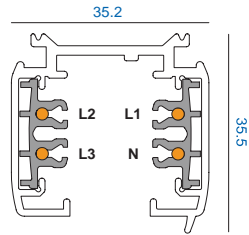

Model No.	Track length	Shell Material	Colour	Package
Pro-0410-W/Pro-0410-S/Pro-0410-B	1M track actual one meter.(100cm)	Aluminum Extrusion	White Silver Black 	1 / 12
Pro-0415-W/Pro-0415-S/Pro-0415-B	1.5M track actual one meter.(150cm)	Aluminum Extrusion	White Silver Black 	1 / 12
Pro-0420-W/Pro-0420-S/Pro-0420-B	2M track actual one meter.(200cm)	Aluminum Extrusion	White Silver Black 	1 / 12
Pro-0430-W/Pro-0430-S/Pro-0430-B	3M track actual one meter.(300cm)	Aluminum Extrusion	White Silver Black 	1 / 8
Pro-04400-W/Pro-04000-S/Pro-04000-B	4M track actual one meter.(400cm)	Aluminum Extrusion	White Silver Black 	1 / 6

Live-End Connector



Model No.	Package	Colour
Pro-0431 L-W	1 / 150	White
Pro-0431 L-S	1 / 150	Silver
Pro-0431 L-B	1 / 150	Black

Live-End Connector

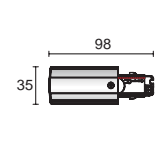

Model No.	Package	Colour
Pro-0431 R-W	1 / 150	White
Pro-0431 R-S	1 / 150	Silver
Pro-0431 R-B	1 / 150	Black

Mini Joiner



Model No.	Package	Colour
Pro-0433-W	1 / 400	White
Pro-0433-S	1 / 400	Silver
Pro-0433-B	1 / 400	Black

Mini Joiner(Insulation)

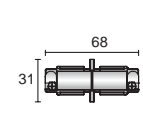

Model No.	Package	Colour
Pro-0433A-W	1 / 150	White
Pro-0433A-S	1 / 150	Silver
Pro-0433A-B	1 / 150	Black

End Cap

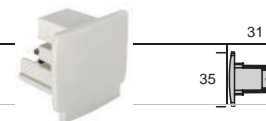

Model No.	Package	Colour
Pro-0432-W	1 / 500	White
Pro-0432-S	1 / 500	Silver
Pro-0432-B	1 / 500	Black

Mini Joiner(Insulation)

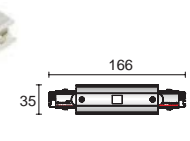

Model No.	Package	Colour
Pro-0434-W	1 / 150	White
Pro-0434-S	1 / 150	Silver
Pro-0434-B	1 / 150	Black

Twisted "L" Connector



Model No.	Package	Colour
Pro-0438-W	1 / 154	White □
Pro-0438-S	1 / 154	Silver ■
Pro-0438-B	1 / 154	Black ■

"+" Connector



Model No.	Package	Colour
Pro-0437-W	1 / 60	White □
Pro-0437-S	1 / 60	Silver ■
Pro-0437-B	1 / 60	Black ■

Ceiling mount, EZCLIK suspension kit with ROD



Model No.	Package	Colour
Pro-EZ0447-W	1 / 200	White □
Pro-EZ0447-S	1 / 200	Silver ■
Pro-EZ0447-B	1 / 200	Black ■

Ceiling mount, EZCLIK suspension kit with wire



Model No.	Package	Colour
Pro-EZ0448-W	1 / 200	White □
Pro-EZ0448-S	1 / 200	Silver ■
Pro-EZ0448-B	1 / 200	Black ■

Flexible Connector

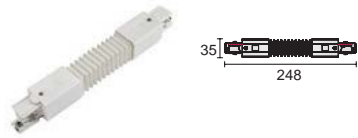

Model No.	Package	Colour
Pro-0439-W	1 / 119	White □
Pro-0439-S	1 / 119	Silver ■
Pro-0439-B	1 / 119	Black ■

Adjustable "L" Connector



Model No.	Package	Colour
Pro-0435-W	1 / 119	White □
Pro-0435-S	1 / 119	Silver ■
Pro-0435-B	1 / 119	Black ■

T-Bar, EZCLIK mounting kit

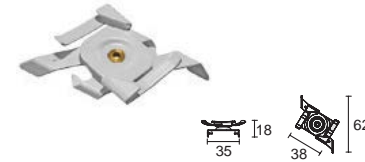

Model No.	Package	Colour
Pro-M146T-W	1 / 500	White □
Pro-M146T-S	1 / 500	Silver ■
Pro-M146T-B	1 / 500	Black ■

Suspension Mounting Kits Manual

1) Adjust the EZCLICK Mounting Kit's Direction, put it vertically into the T-Bar ceiling, and then rotate right and fix (as picture shows).

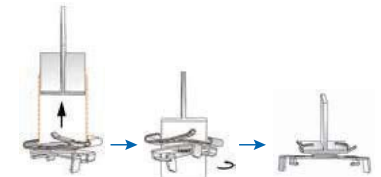

2) Adjust the EZCLICK Mounting Kit's Direction, put the track vertically into the EZCLICK Mounting Kit, rotate left and fix (like picture shows).

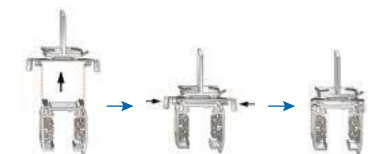

Ceiling Mount Reinforcement Plate with suspension wire

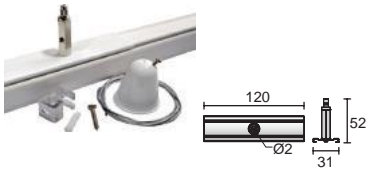

Model No.	Package	Colour
Pro-M147-W	1 / 200	White □
Pro-M147-S	1 / 200	Silver ■
Pro-M147-B	1 / 200	Black ■

Ceiling Mount Reinforcement Plate with suspension rod

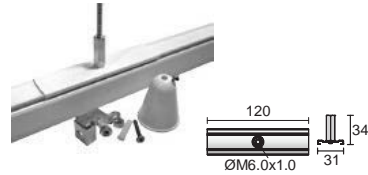

Model No.	Package	Colour
Pro-M148-W	1 / 200	White □
Pro-M148-S	1 / 200	Silver ■
Pro-M148-B	1 / 200	Black ■

T-Bar, EZCLICK with Reinforcement Plate

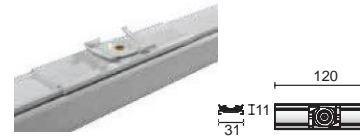

Model No.	Package	Colour
Pro-M149-W	1 / 200	White □
Pro-M149-S	1 / 200	Silver ■
Pro-M149-B	1 / 200	Black ■

Suspension Hook



Model No.	Package	Colour
Pro-M142-W	1 / 500	White □
Pro-M142-S	1 / 500	Silver ■
Pro-M142-B	1 / 500	Black ■

Suspension Mounting Kits Manual

1) Put the Track into the EZCLICK Mounting Kits Parallel (As picture shows).

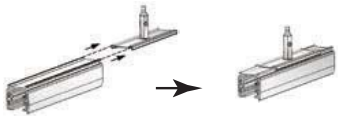

2) Release the start valve, press and get the wirerope through the EZCLICK Mounting Kit, rotate tight the start valve and lock the wirerope (like picture shows).



Suspension Mounting Kits Manual

1) Put the Track into the EZCLICK Kit Parallel (As picture shows).



2) Rotate right the EZCLICK Kit and fix it on the rod.

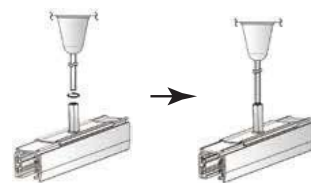

Suspension Mounting Kits Manual

1) Put the Track into the EZCLICK Mounting Kits parallel (As picture shows).

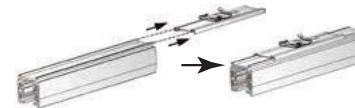

2) Adjust the EZCLICK Mounting Kit's direction, put the track vertically into the EZCLICK Mounting Kit, rotate right and fix (like picture shows).



Mechanical Adaptor



Model No.	Package	Colour
Pro-0449-W	1 / 100	White □
Pro-0449-S	1 / 100	Silver ■
Pro-0449-B	1 / 100	Black ■

Suspension kit



Model No.	Package	Colour
Pro-04SK-W	1 / 100	White □
Pro-04SK-S	1 / 100	Silver ■
Pro-04SK-B	1 / 100	Black ■

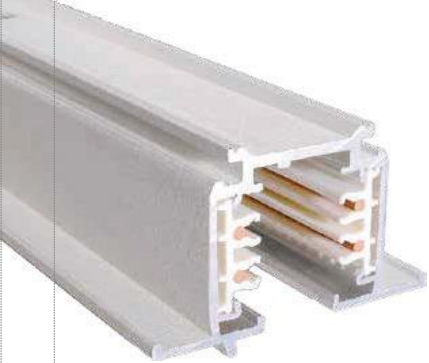

3 Circuits Recessed Track System

56

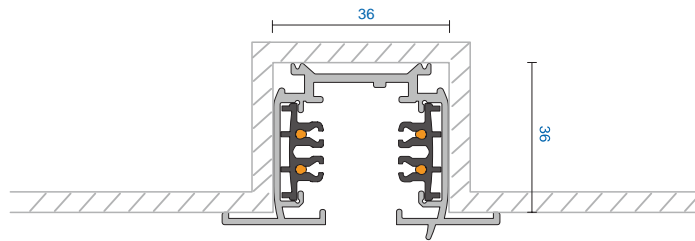
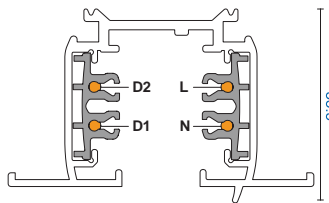

Model No.	Track length	Shell Material	Colour	Package
Pro-R410-W/Pro-R410-S/Pro-R410-B	1M track actual one meter.(100cm)	Aluminum Extrusion	White <input type="checkbox"/> Silver <input type="checkbox"/> Black <input type="checkbox"/>	1 / 9
Pro-R415-W/Pro-R415-S/Pro-R415-B	1.5M track actual one meter.(150cm)	Aluminum Extrusion	White <input type="checkbox"/> Silver <input type="checkbox"/> Black <input type="checkbox"/>	1 / 9
Pro-R420-W/Pro-R420-S/Pro-R420-B	2M track actual one meter.(200cm)	Aluminum Extrusion	White <input type="checkbox"/> Silver <input type="checkbox"/> Black <input type="checkbox"/>	1 / 9
Pro-R430-W/Pro-R430-S/Pro-R430-B	3M track actual one meter.(300cm)	Aluminum Extrusion	White <input type="checkbox"/> Silver <input type="checkbox"/> Black <input type="checkbox"/>	1 / 6
Pro-R4400-W/Pro-R4400-S/Pro-R4400-B	4M track actual one meter.(400cm)	Aluminum Extrusion	White <input type="checkbox"/> Silver <input type="checkbox"/> Black <input type="checkbox"/>	1 / 6

Live-end Connector Cover



Model No.	Package	Colour
Pro-R431-W	1 / 500	White <input type="checkbox"/>
Pro-R431-S	1 / 500	Silver <input type="checkbox"/>
Pro-R431-B	1 / 500	Black <input type="checkbox"/>

Live-End Connector



Model No.	Package	Colour
Pro-R434-W	1 / 400	White <input type="checkbox"/>
Pro-R434-S	1 / 400	Silver <input type="checkbox"/>
Pro-R434-B	1 / 400	Black <input type="checkbox"/>

Mini Joiner



Model No.	Package	Colour
Pro-R435-W	1 / 400	White <input type="checkbox"/>
Pro-R435-S	1 / 400	Silver <input type="checkbox"/>
Pro-R435-B	1 / 400	Black <input type="checkbox"/>

Mini Joiner(Insulation)



Model No.	Package	Colour
Pro-R436-W	1 / 400	White <input type="checkbox"/>
Pro-R436-S	1 / 400	Silver <input type="checkbox"/>
Pro-R436-B	1 / 400	Black <input type="checkbox"/>

End Cap



Model No.	Package	Colour
Pro-R437-W	1 / 400	White <input type="checkbox"/>
Pro-R437-S	1 / 400	Silver <input type="checkbox"/>
Pro-R437-B	1 / 400	Black <input type="checkbox"/>

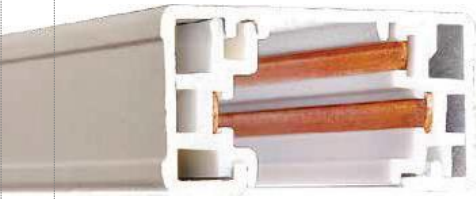

Single Circuit Track System

3 Wires

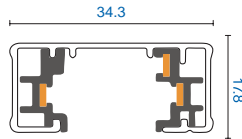

Model No.	Track length	Shell Material	Colour	Package
Pro-0310A	1M track with double end cap.(100cm)	Aluminum Extrusion	White <input type="checkbox"/> Silver <input type="checkbox"/> Black <input type="checkbox"/>	1 / 12
Pro-0320A	2M track with double end cap.(200cm)	Aluminum Extrusion	White <input type="checkbox"/> Silver <input type="checkbox"/> Black <input type="checkbox"/>	1 / 12
Pro-0330A	3M track with double end cap.(300cm)	Aluminum Extrusion	White <input type="checkbox"/> Silver <input type="checkbox"/> Black <input type="checkbox"/>	1 / 9
Pro-03400A	4M track with double end cap.(400cm)	Aluminum Extrusion	White <input type="checkbox"/> Silver <input type="checkbox"/> Black <input type="checkbox"/>	1 / 9
Pro-0302A	2'track with double end cap actual length24"	Aluminum Extrusion	White <input type="checkbox"/> Silver <input type="checkbox"/> Black <input type="checkbox"/>	1 / 12
Pro-0304A	4'track with double end cap actual length48"	Aluminum Extrusion	White <input type="checkbox"/> Silver <input type="checkbox"/> Black <input type="checkbox"/>	1 / 12
Pro-0306A	6'track with double end cap actual length72"	Aluminum Extrusion	White <input type="checkbox"/> Silver <input type="checkbox"/> Black <input type="checkbox"/>	1 / 12
Pro-0308A	8'track with double end cap actual length96"	Aluminum Extrusion	White <input type="checkbox"/> Silver <input type="checkbox"/> Black <input type="checkbox"/>	1 / 12
Pro-0310B	1M track with live end & end cap.(100cm)	Aluminum Extrusion	White <input type="checkbox"/> Silver <input type="checkbox"/> Black <input type="checkbox"/>	1 / 12
Pro-0320B	2M track with live end & end cap.(200cm)	Aluminum Extrusion	White <input type="checkbox"/> Silver <input type="checkbox"/> Black <input type="checkbox"/>	1 / 12
Pro-0330B	3M track with live end & end cap.(300cm)	Aluminum Extrusion	White <input type="checkbox"/> Silver <input type="checkbox"/> Black <input type="checkbox"/>	1 / 9
Pro-03400B	4M track with live end & end cap.(400cm)	Aluminum Extrusion	White <input type="checkbox"/> Silver <input type="checkbox"/> Black <input type="checkbox"/>	1 / 9
Pro-0302B	2'track with live end and end cap actual length24"	Aluminum Extrusion	White <input type="checkbox"/> Silver <input type="checkbox"/> Black <input type="checkbox"/>	1 / 12
Pro-0304B	4'track with live end and end cap actual length48"	Aluminum Extrusion	White <input type="checkbox"/> Silver <input type="checkbox"/> Black <input type="checkbox"/>	1 / 12
Pro-0306B	6'track with live end and end cap actual length72"	Aluminum Extrusion	White <input type="checkbox"/> Silver <input type="checkbox"/> Black <input type="checkbox"/>	1 / 12
Pro-0308B	8'track with live end and end cap actual length96"	Aluminum Extrusion	White <input type="checkbox"/> Silver <input type="checkbox"/> Black <input type="checkbox"/>	1 / 12
Pro-0310C	1M track with live end & end cap.(100cm)	Aluminum Extrusion	White <input type="checkbox"/> Silver <input type="checkbox"/> Black <input type="checkbox"/>	1 / 12
Pro-0320C	2M track with live end & end cap.(200cm)	Aluminum Extrusion	White <input type="checkbox"/> Silver <input type="checkbox"/> Black <input type="checkbox"/>	1 / 12
Pro-0330C	3M track with live end & end cap.(300cm)	Aluminum Extrusion	White <input type="checkbox"/> Silver <input type="checkbox"/> Black <input type="checkbox"/>	1 / 9
Pro-03400C	4M track with live end & end cap.(400cm)	Aluminum Extrusion	White <input type="checkbox"/> Silver <input type="checkbox"/> Black <input type="checkbox"/>	1 / 9
Pro-0302C	2'track with live end and end cap actual length24"	Aluminum Extrusion	White <input type="checkbox"/> Silver <input type="checkbox"/> Black <input type="checkbox"/>	1 / 12
Pro-0304C	4'track with live end and end cap actual length48"	Aluminum Extrusion	White <input type="checkbox"/> Silver <input type="checkbox"/> Black <input type="checkbox"/>	1 / 12
Pro-0306C	6'track with live end and end cap actual length72"	Aluminum Extrusion	White <input type="checkbox"/> Silver <input type="checkbox"/> Black <input type="checkbox"/>	1 / 12
Pro-0308C	8'track with live end and end cap actual length96"	Aluminum Extrusion	White <input type="checkbox"/> Silver <input type="checkbox"/> Black <input type="checkbox"/>	1 / 12

Single Circuit Recessed

3 Wires

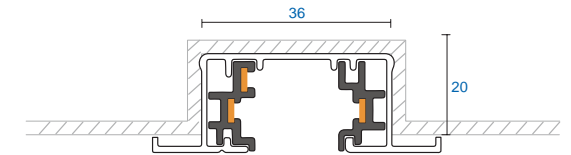
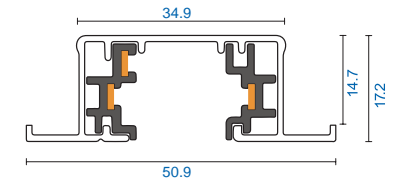

Model No.	Track length	Shell Material	Colour	Package
Pro-R310A	1M track with double end cap.(100cm)	Aluminum Extrusion	White <input type="checkbox"/> Silver <input type="checkbox"/> Black <input type="checkbox"/>	1 / 12
Pro-R320A	2M track with double end cap.(200cm)	Aluminum Extrusion	White <input type="checkbox"/> Silver <input type="checkbox"/> Black <input type="checkbox"/>	1 / 12
Pro-R330A	3M track with double end cap.(300cm)	Aluminum Extrusion	White <input type="checkbox"/> Silver <input type="checkbox"/> Black <input type="checkbox"/>	1 / 12
Pro-R3400A	4M track with double end cap.(400cm)	Aluminum Extrusion	White <input type="checkbox"/> Silver <input type="checkbox"/> Black <input type="checkbox"/>	1 / 9
Pro-R302A	2'track with double end cap actual length24"	Aluminum Extrusion	White <input type="checkbox"/> Silver <input type="checkbox"/> Black <input type="checkbox"/>	1 / 12
Pro-R304A	4'track with double end cap actual length48"	Aluminum Extrusion	White <input type="checkbox"/> Silver <input type="checkbox"/> Black <input type="checkbox"/>	1 / 12
Pro-R306A	6'track with double end cap actual length72"	Aluminum Extrusion	White <input type="checkbox"/> Silver <input type="checkbox"/> Black <input type="checkbox"/>	1 / 12
Pro-R308A	8'track with double end cap actual length96"	Aluminum Extrusion	White <input type="checkbox"/> Silver <input type="checkbox"/> Black <input type="checkbox"/>	1 / 12
Pro-R310B	1M track with live end & end cap.(100cm)	Aluminum Extrusion	White <input type="checkbox"/> Silver <input type="checkbox"/> Black <input type="checkbox"/>	1 / 12
Pro-R320B	2M track with live end & end cap.(200cm)	Aluminum Extrusion	White <input type="checkbox"/> Silver <input type="checkbox"/> Black <input type="checkbox"/>	1 / 12
Pro-R330B	3M track with live end & end cap.(300cm)	Aluminum Extrusion	White <input type="checkbox"/> Silver <input type="checkbox"/> Black <input type="checkbox"/>	1 / 12
Pro-R3400B	4M track with live end & end cap.(400cm)	Aluminum Extrusion	White <input type="checkbox"/> Silver <input type="checkbox"/> Black <input type="checkbox"/>	1 / 9
Pro-R302B	2'track with live end and end cap actual length24"	Aluminum Extrusion	White <input type="checkbox"/> Silver <input type="checkbox"/> Black <input type="checkbox"/>	1 / 12
Pro-R304B	4'track with live end and end cap actual length48"	Aluminum Extrusion	White <input type="checkbox"/> Silver <input type="checkbox"/> Black <input type="checkbox"/>	1 / 12
Pro-R306B	6'track with live end and end cap actual length72"	Aluminum Extrusion	White <input type="checkbox"/> Silver <input type="checkbox"/> Black <input type="checkbox"/>	1 / 12
Pro-R308B	8'track with live end and end cap actual length96"	Aluminum Extrusion	White <input type="checkbox"/> Silver <input type="checkbox"/> Black <input type="checkbox"/>	1 / 12

Single Circuit Track System

2 Wires

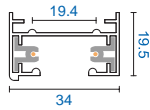

Model No.	Track length	Shell Material	Colour
Pro-L210-W	1M / 1.5M / 2M / 3M track actual one meter. (100cm / 150cm / 200cm / 300cm)	Aluminum Extrusion	White <input type="checkbox"/> Silver <input type="checkbox"/> Black <input type="checkbox"/>



Model No.	Track length	Shell Material	Colour
Pro-RL210-W	1M / 1.5M / 2M / 3M track actual one meter. (100cm / 150cm / 200cm / 300cm)	Aluminum Extrusion	White <input type="checkbox"/> Silver <input type="checkbox"/> Black <input type="checkbox"/>

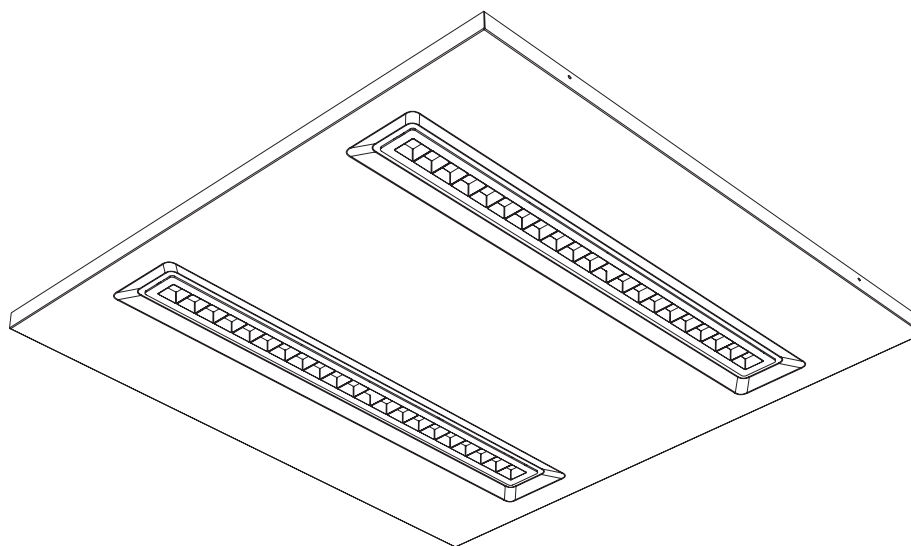

LED Panel Light /Series/

LED panel light is one of the most popular luminaire for commercial lighting, with continuous modification of its design, light efficiency, CRI, UGR and smart function, ELWA Lighting is always capable of providing customers with helpful solution and best price, that's the main reason ELWA Lighting is preferred supplier of LED panel lamp in the market. ELWA LED panel family supply different solution for project and distribution, such us regular LED panel with high Lumen and low UGR, CCT changing LED panel, waterproof led panel, frameless led panel, Up/down emitting led panel, big size round led panel with recessed / surface mounted / pendant installation, TUV-CE approved ELWA driver and Lifud, Tridonic, Philips driver ensure our reputation of quality always.

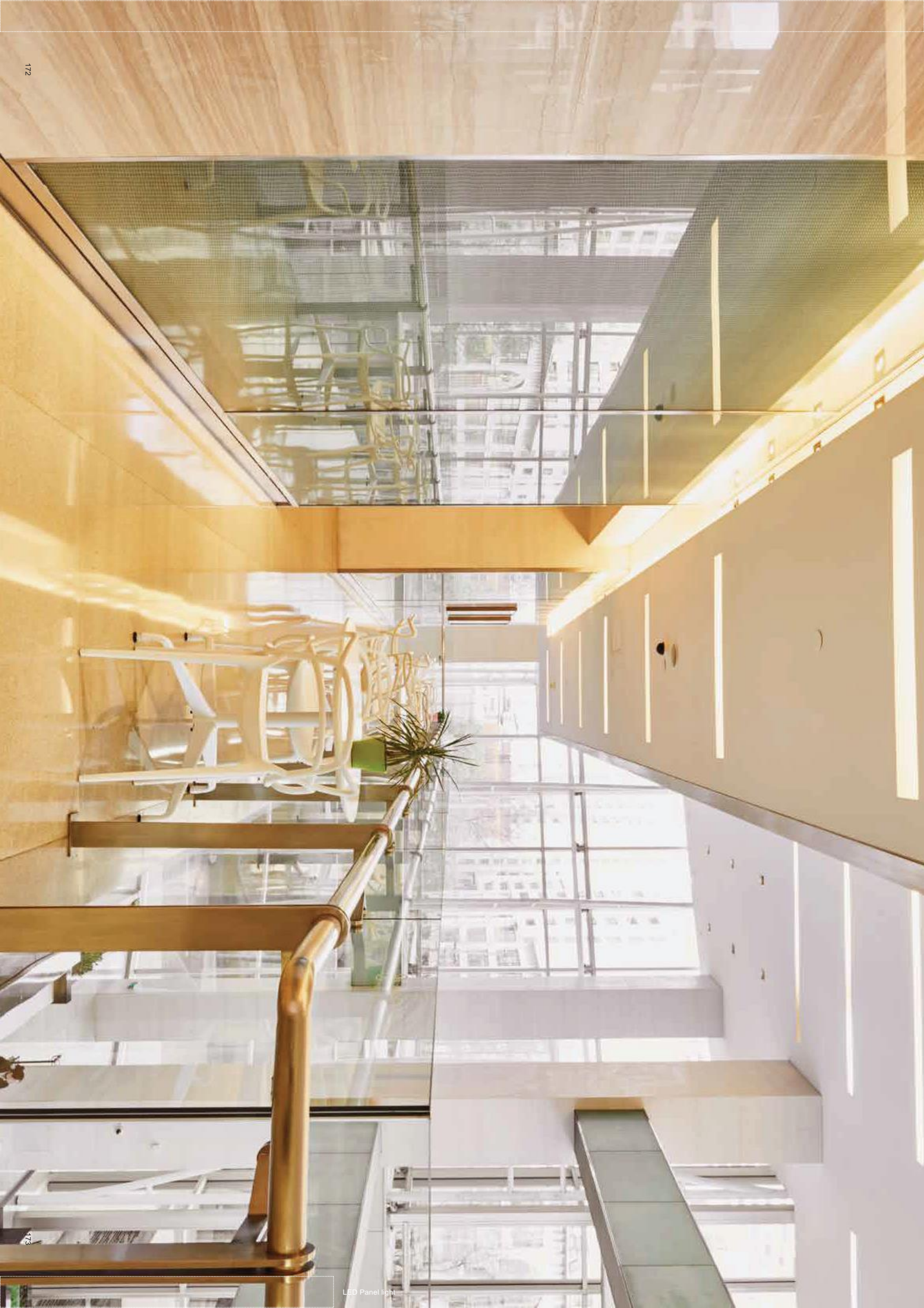

LED Panel light



DIY Surface Mounted Frame



Surface Mounted Frame



Embedded Mounted Frame



Suspending Kits



Recessed Installation Clips

PL-A Panel light

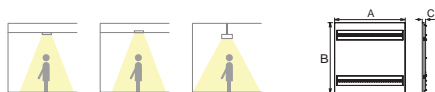

Featuring louver reflectors design technology with low UGR and 115lm/W, PL-A is designed for offices and some places where is comfortable working environment. It is an ideal replacement for traditional troffer T8 /T5 grill light.

Model	Watt	Size(AxBxCmm)	Cut-out(±5mm)	Lumen(±5)	N.W/pc(kgs)	Q'ty/CTN
PL6060-30W-A	30W	595x595x28	580x580	3450lm	3	5PCS
PL6060-35W-A	35W	595x595x28	580x580	3955lm	3	5PCS
PL30120-30W-A	30W	1195x295x28	1180x280	3450lm	3	5PCS
PL30120-35W-A	35W	1195x295x28	1180x280	3955lm	3	5PCS

CCT



Finish



PL-AZ Panel light



PL-AZ panel adopts replaceable luminous module which ensure easy maintenance. It is UGR<19, an ideal replacement for traditional troffer T8/T5 grill light. With high lumen efficiency 100-115lm/w, it's a nice choice for office project.

Model	Watt	Size(AxBxCmm)	Cut-out(±5mm)	Lumen(±5)	N.W/pc(kgs)	Q'ty/CTN
PL6060-30W-AZ	30W	595x595x15	580x580	3450lm	3.2	4PCS
PL6060-35W-AZ	35W	595x595x15	580x580	3950lm	3.2	4PCS
PL6262-30W-AZ	30W	620x620x15	605x605	3450lm	3.5	4PCS
PL6262-35W-AZ	35W	620x620x15	605x605	3950lm	3.5	4PCS
PL30120-30W-AZ	30W	1195x295x17.5	1180x280	3450lm	3.6	4PCS
PL30120-35W-AZ	35W	1195x295x17.5	1180x280	3950lm	3.6	4PCS

CCT



Finish



PL-AK Panel light

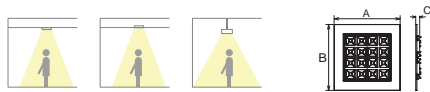

PL-AK adopts full louver reflector design to satisfy UGR<16. Module replaceable and multi lumen efficiency options: 110lm/w, 120lm/w, 140lm/w, make this fitting suitable for various kinds of project demand.

Model	Watt	Size(AxBxCmm)	Cut-out(±5mm)	Lumen(±5)	N.W/pc(kgs)	Q'ty/CTN
PL3060-18W-AK	18W	595x295x36	580x280	2010lm	1.55	4PCS
PL6060-25W-AK	25W	595x595x36	580x580	3552lm	2.9	4PCS
PL6060-30W-AK	30W	595x595x36	580x580	3660lm	2.9	4PCS
PL6060-36W-AK	36W	595x595x36	580x580	3900lm	2.9	4PCS
PL6262-36W-AK	36W	620x620x36	605x605	3900lm	3.3	4PCS
PL30120-36W-AK	36W	1195x295x36	1180x280	3920lm	2.95	4PCS

CCT



Finish



PL-AW Panel light

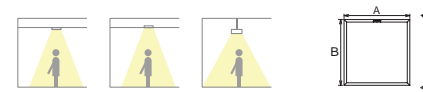

PL-AW is a smart sensor LED Panel. It adopts Daylight Sensor and Microwave Motion Sensor to adjust the brightness automatically. Detection area, daylight sensor lux value, delay time, hold time, brightness could be set by remote controller according to customers' demand.

Model	Watt	Size(AxBxCxDmm)	Cut-out(±5mm)	Lumen(±5)	N.W/pc(kgs)	Q'ty/CTN
PL6060-40W-AW-SO	40W	595x595x44x8	580x580	3790lm	3.46	4PCS
PL6262-40W-AW-SO	40W	620x620x44x8	605x605	3790lm	3.7	4PCS
PL30120-40W-AW-SO	40W	295x1195x44x8	1180x280	3680lm	3.8	4PCS

CCT



Finish



PL-AM1 Panel light

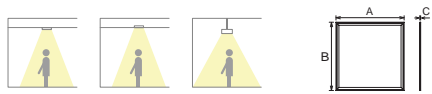
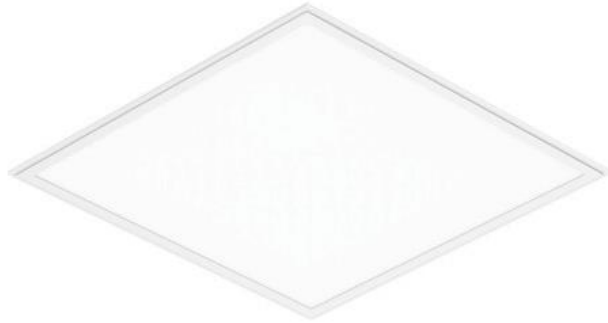
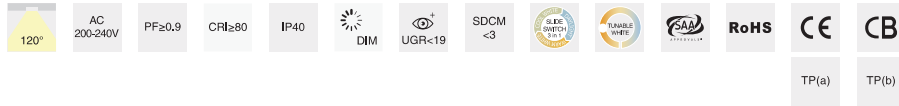

PL-AM1 is a basic series edge-lit panel with step frame. The thickness is 8mm only, and light guide plate (LGP) with PMMA or PS for options. The Lifud brand LED driver is available.

Model	Watt	Size(AxBxCmm)	Cut-out(±5mm)	Lumen(±5)	N.W/pc(kgs)	Q'ty/CTN
PL3030-18W-AM1	18W	295x295x8	280x280	1355lm	1.2	5PCS
PL6060-36W-AM1	36W	595x595x8	580x580	3200lm	2.28	5PCS
PL6262-36W-AM1	36W	620x620x8	605x605	3105lm	3.1	5PCS
PL30120-36W-AM1	36W	1195x295x8	1180x280	3190lm	2.3	5PCS
PL60120-60W-AM1	60W	1195x595x8	1180x580	5760lm	5	2PCS

CCT



Finish



PL-AF1 Panel light

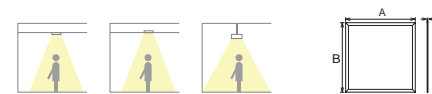

PL-AF1 is a basic series edge-lit panel with step frame. The thickness is 8mm only, and light guide plate (LGP) with PMMA or PS for options. The Lifud brand LED driver is available.

Model	Watt	Size(AxBxCmm)	Cut-out(±5mm)	Lumen(±5)	N.W/pc(kgs)	Q'ty/CTN
PL3030-18W-AF1	18W	295x295x8	280x280	1355lm	1.2	5PCS
PL6060-36W-AF1	36W	595x595x8	580x580	3200lm	2.28	5PCS
PL6262-36W-AF1	36W	620x620x8	605x605	3105lm	3.1	5PCS
PL30120-36W-AF1	36W	1195x295x8	1180x280	3190lm	2.3	5PCS
PL60120-60W-AF1	60W	1195x595x8	1180x580	5760lm	5	2PCS

CCT



Finish



PL-CK Panel light

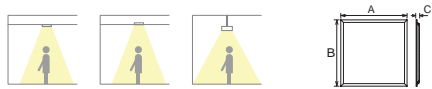

PL-CK is a back-lit Led panel with 30mm thickness and no lighting guide plate (LGP) version. Standard UGR and UGR19 for choices, high efficiency is available with 100lm/W and 120lm/W and 130lm/W and 140lm/W.

Model	Watt	Size(AxBxCmm)	Cut-out(±5mm)	Lumen(±5)	N.W/pc(kgs)	Q'ty/CTN
PL6060-36W-CK	36W	595x595x30	580x580	100LM/W	1.72	5PCS
PL6262-36W-CK	36W	620x620x30	605x605	100LM/W	1.98	5PCS
PL30120-36W-CK	36W	1195x295x30	1180x280	100LM/W	1.72	5PCS
PL60120-60W-CK	60W	1195x595x30	1180x580	100LM/W	3.2	4PCS
PL6060-30W-CK	30W	595x595x30	580x580	120LM/W	1.72	5PCS
PL30120-36W-CK	36W	1195x295x30	1180x280	120LM/W	1.72	5PCS
PL60120-50W-CK	50W	1195x595x30	1180x580	120LM/W	3.2	4PCS
PL60120-60W-CK	60W	1195x595x30	1180x580	120LM/W	3.2	4PCS
PL6060-25W-CK	25W	595x595x30	580x580	130LM/W	1.72	5PCS
PL6060-30W-CK	30W	595x595x30	580x580	130LM/W	1.72	5PCS
PL30120-36W-CK	36W	1195x295x30	1180x280	130LM/W	1.72	5PCS
PL60120-42W-CK	42W	1195x595x30	1180x580	130LM/W	3.2	4PCS
PL60120-50W-CK	50W	1195x595x30	1180x580	130LM/W	3.2	4PCS
PL60120-60W-CK	60W	1195x595x30	1180x580	130LM/W	3.2	4PCS

CCT



Finish



White

PL-CB Panel light

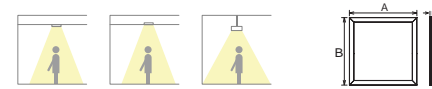
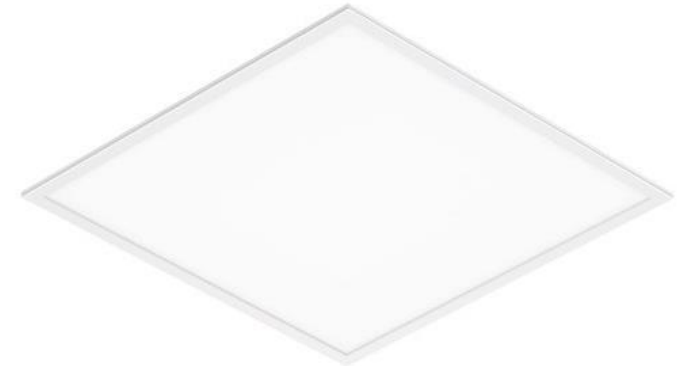

PL-CB is a new panel light solution with stronger frame structure (9mm thickness), PMMA LGP produce uniform light and high lumen output, 100lm/W and 130lm/W for choices, brand drivers are optional.

Model	Watt	Size(AxBxCmm)	Cut-out(±5mm)	Lumen(±5)	N.W/pc(kgs)	Q'ty/CTN
PL3030-18W-CB	18W	295x295x9	280x280	100LM/W	0.85	5PCS
PL3060-20W-CB	20W	595x295x9	580x580	100LM/W	1.35	5PCS
PL30120-33W-CB	33W	1195x295x9	1180x280	100LM/W	2.4	5PCS
PL30120-42W-CB	42W	1195x295x9	1180x280	100LM/W	2.4	5PCS
PL6060-33W-CB	33W	595x595x9	580x580	100LM/W	2.35	5PCS
PL6060-42W-CB	42W	595x595x9	580x580	100LM/W	2.35	5PCS
PL60120-60W-CB	60W	1195x595x9	1180x580	100LM/W	5.3	2PCS
PL6262-33W-CB	33W	620x620x9	605x605	100LM/W	2.55	5PCS
PL6262-42W-CB	42W	620x620x9	605x605	100LM/W	2.55	5PCS
PL6060-25W-CB	25W	595x595x9	580x580	130LM/W	2.35	5PCS
PL6262-25W-CB	25W	620x620x9	605x605	130LM/W	2.55	5PCS
PL30120-25W-CB	25W	1195x295x9	1180x280	130LM/W	2.4	5PCS

CCT



Finish



White

PL-CC Panel light

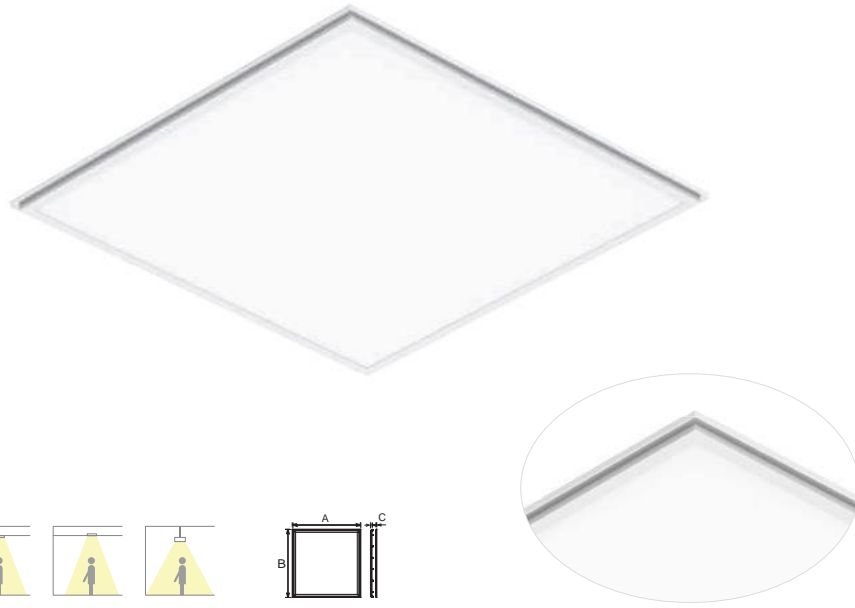

PL-CC panel light adopts high lumen LED chip with CRI>80. PMMA LGP produces uniform and comfortable light. Stronger and unique stepped frame shape is designed to be recessed in parallel with ceiling.

Model	Watt	Size(AxBxCmm)	Cut-out(±5mm)	Lumen(±5)	N.W/pc(kgs)	Q'ty/CTN
PL6060-33W-CC	33W	595x595x14.3	580x580	3530lm	2.5	5PCS
PL6060-42W-CC	42W	595x595x14.3	580x580	4370lm	2.5	5PCS
PL30120-33W-CC	33W	1195x295x14.3	1180x280	3400lm	2.65	5PCS
PL30120-42W-CC	42W	1195x295x14.3	1180x280	4210lm	2.65	5PCS

CCT



Finish



PL-CD Panel light



Special frame design provides excellent thermal management, high lumen with 100lm/W. Recessed installation with clips makes it suitable and easier for more kinds of ceiling.

Model	Watt	Size(AxBxCxDmm)	Cut-out(±5mm)	Lumen(±5)	N.W/pc(kgs)	Q'ty/CTN
PL6060-33W-CD	33W	595x595x8.5x35.5	580x580	3460lm	2.35	5PCS
PL30120-33W-CD	33W	1195x295x8.5x35.5	1180x280	3400lm	2.4	5PCS

CCT



Finish



PL-G5A Panel light

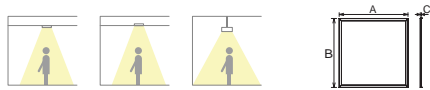

PL-G5A is a edge-lit led panel with 10mm thickness, it adopts PMMA LGP to avoid yellowing issue, high efficiency 100lm/W and 120lm/W for choices.

Model	Watt	Size(AxBxCmm)	Cut-out(±5mm)	Lumen(±5)	N.W/pc(kgs)	Q'ty/CTN
PL3030-18W-G5A	18W	295x295x10	280x280	1685lm	1.35	5PCS
PL3060-20W-G5A	20W	595x295x10	580x280	1920lm	2.5	5PCS
PL30120-26W-G5A	26W	1195x295x10	1180x280	3210lm	3.8	5PCS
PL30120-42W-G5A	42W	1195x295x10	1180x280	4200lm	3.8	5PCS
PL6060-26W-G5A	26W	595x595x10	580x580	3265lm	3.7	5PCS
PL6060-42W-G5A	42W	595x595x10	580x580	4250lm	3.7	5PCS
PL60120-60W-G5A	60W	1195x595x10	1180x580	6240lm	7.5	2PCS
PL6262-26W-G5A	26W	620x620x10	605x605	3290lm	4.2	5PCS
PL6262-42W-G5A	42W	620x620x10	605x605	4250lm	4.2	5PCS

CCT



Finish



PL-G6A Panel light

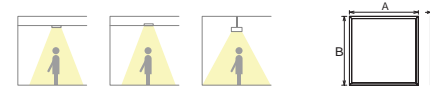

PL-G6A is a edge-lit led panel with 10mm thickness, it adopts PMMA LGP to avoid yellowing issue, UGR<19 , high efficiency 100lm/W and 120lm/W for choices.

Model	Watt	Size(AxBxCmm)	Cut-out(±5mm)	Lumen(±5)	N.W/pc(kgs)	Q'ty/CTN
PL3030-18W-G6A	18W	295x295x10	280x280	1665lm	1.35	5PCS
PL3060-20W-G6A	20W	595x295x10	580x280	1900lm	2.5	5PCS
PL30120-26W-G6A	26W	1195x295x10	1180x280	3175lm	3.8	5PCS
PL30120-42W-G6A	42W	1195x295x10	1180x280	4200lm	3.8	5PCS
PL6060-26W-G6A	26W	595x595x10	580x580	3190lm	3.7	5PCS
PL6060-42W-G6A	42W	595x595x10	580x580	4250lm	3.7	5PCS
PL60120-60W-G6A	60W	1195x595x10	1180x580	6060lm	7.5	2PCS
PL6262-26W-G6A	26W	620x620x10	605x605	3230lm	4.2	5PCS
PL6262-42W-G6A	42W	620x620x10	605x605	4250lm	4.2	5PCS

CCT



Finish



PL-BC Panel light



PL-BC consists of metal frame and prismatic diffuser (UGR<19).The metal frame with air slot design to allow the air to circulate. Ideal replacement for traditional T8 and side-lit panel light.

Model	Watt	Size(AxBxCmm)	Cut-out(±5mm)	Lumen(±5)	N.W/pc(kgs)	Q'ty/CTN
PL6060-40W-BC	40W	595x595x11	580x580	4165lm	/	/
Panel Module	/	570x415x8	/	/	1.85	5PCS
Panel Frame	/	595x595x11	/	/	1.4	5PCS

CCT



Finish



PL-B1 Panel light

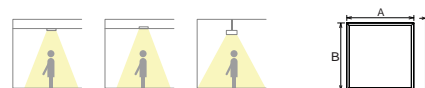

PL-B1 LED panel light with blue tooth control system via a free APP to provide an convenient and cost-effective way to personalize lighting effect, flexible CCT changeable. The system also allows multiple devices to be connected simultaneously. So the entire panel family can stay connected.

Model	Watt	Size(AxBxCmm)	Cut-out(±5mm)	Lumen(±5)	N.W/pc(kgs)	Q'ty/CTN
PL6060-45W-G2-B1	45W	595x595x10	580x580	3400lm	4.2	5PCS

CCT



Finish



PL-CQ Panel light

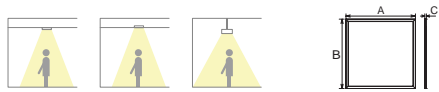
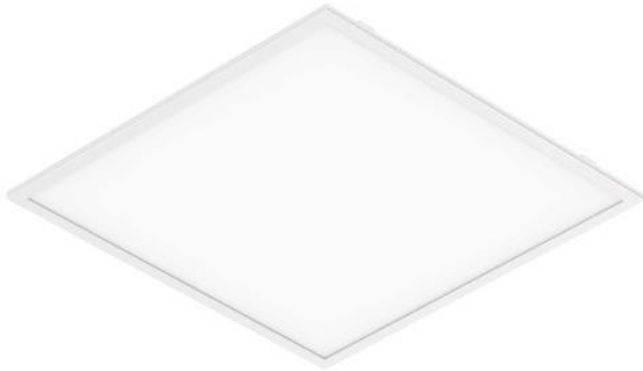

PL-CQ is IP65 waterproof structural design, IP65 driver available. It is a complementary for existing panel versions. Normally used to replace grid lamp in damp locations. The ultra slim profile fits seamlessly into various installation ways.

Model	Watt	Size(AxBxCmm)	Cut-out(±5mm)	Lumen(±5)	N.W/pc(kgs)	Q'ty/CTN
PL6060-36W-CQ	36W	595x595x8	580x580	3600lm	1.1	5PCS
PL6262-36W-CQ	36W	620x620x8	605x605	3600lm	4.2	5PCS
PL30120-36W-CQ	36W	1195x295x8	1180x280	3600lm	3.3	5PCS

CCT



Finish



PL-L Panel light

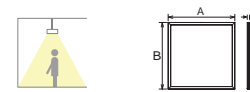

Double-sided panel light is designed for special decorative application. 70% light downward and 30% upward. High quality LGP creates extremely uniform light. It's an ideal choice for commercial and residential applications.

Model	Watt	Size(AxBxCmm)	Cut-out(±5mm)	Lumen(±5)	N.W/pc(kgs)	Q'ty/CTN
PL30120-45W-L	45W	1195x295x9.12	1180x280	3100lm	4.5	5PCS
PL6060-45W-L	45W	595x595x9.12	580x580	3100lm	6.85	3PCS
PL60120-72W-L	72W	1195x595x9.12	1180x280	4770lm	7.8	2PCS

CCT



Finish



Small size round panel light



Super Slim round panel provided in full diameter. External driver comes with triac dim. It shares great popularity by perfect dimming range and great compatibility with worldwide dimmers. The ultra slim profile fits perfectly for all working places.

Model	Watt	Size(AxBmm)	Cut-out(±5mm)	Lumen(±5)	N.W/pc(kgs)	Q'ty/CTN
PL1219-7W	7W	Ø120x21	Ø110	530lm	0.32	10PCS
PL14519-7W	7W	Ø146x21	Ø135	550lm	0.35	10PCS
PL1819-10W	10W	Ø173x21.5	Ø160	780lm	0.42	10PCS
PL2019-10W	10W	200x21	Ø190	780lm	0.55	10PCS
PL2019-15W	15W	200x21	Ø190	1130lm	0.55	10PCS
PL2219-15W	15W	224x21	Ø210	1130lm	0.7	10PCS
PL2419-15W	15W	240x21	Ø230	1180lm	0.75	10PCS
PL2419-20W	20W	240x21	Ø230	1460lm	0.75	10PCS
PL3019-20W	20W	300x21	Ø285	1520lm	0.86	10PCS

CCT

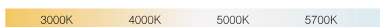

Finish



Small size square panel light

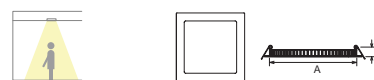

Super slim square panel provided in full diameter. External driver comes with triac dim. It shares great popularity by perfect dimming range and great compatibility with worldwide dimmers. The ultra slim profile fits perfectly for all working places.

Model	Watt	Size(AxAxBmm)	Cut-out(±5mm)	Lumen(±5)	N.W/pc(kgs)	Q'ty/CTN
PL1212-7W	7W	120x120x21	110x110	530lm	0.35	10PCS
PL1515-7W	7W	146x146x21	135x135	550lm	0.4	10PCS
PL1818-10W	10W	171x171x21	160x160	780lm	0.45	10PCS
PL2020-10W	10W	200x200x21	190x190	780lm	0.6	10PCS
PL2020-15W	15W	200x200x21	190x190	1150lm	0.6	10PCS
PL2222-15W	15W	225x225x21	210x210	1130lm	0.75	10PCS
PL2424-15W	15W	235x235x21	220x220	1180lm	0.8	10PCS
PL3030-20W	20W	300x300x21	285x285	1520lm	0.9	10PCS

CCT



Finish



PL-W Panel light

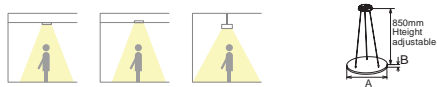

Elegant and round shape design creates soft lighting effect, acts as a decorative light in most applications.

Model	Watt	Size(AxBmm)	Lumen(±5)	N.W/pc(kgs)	Q'ty/CTN
PL3012-18W-W	18W	Ø300x12	1560lm	2.5	5PCS
PL4012-25W-W	25W	Ø400x12	2170lm	3.1	4PCS
PL4012-35W-W	35W	Ø400x12	2900lm	3.1	4PCS
PL5012-30W-W	30W	Ø500x12	2520lm	4.2	4PCS
PL5012-35W-W	35W	Ø500x12	2900lm	4.2	4PCS
PL6012-35W-W	35W	Ø600x12	3040lm	4.35	2PCS
PL6012-45W-W	45W	Ø600x12	3600lm	4.35	2PCS
PL8012-60W-W	60W	Ø780x20	5430lm	6.1	2PCS
PL10012-60W-W	60W	Ø1000x20	6200lm	8.9	2PCS

CCT



Finish



GL-N Troffer light

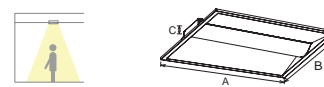

New LED troffer light adopts secondary optical designed and special treatment diffuser to achieve more uniform and softer light, provides more comfortable visual experience. Luminous efficiency 105lm/W. Powder spraying surface treatment is employed in the lamp fixture which makes the lamp corrosion resistant. Designed for grid ceiling commercial applications.

Model	Watt	Size(AxBxCmm)	Cut-out(±5mm)	Lumen(±5)	N.W/pc(kgs)	Q'ty/CTN
GL6060-33W-N	33W	595x595x54	580x580	3850lm	2.5	5PCS
GL30120-33W-N	33W	1195x295x54	1180x280	3850lm	2.7	5PCS

CCT

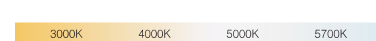

Finish



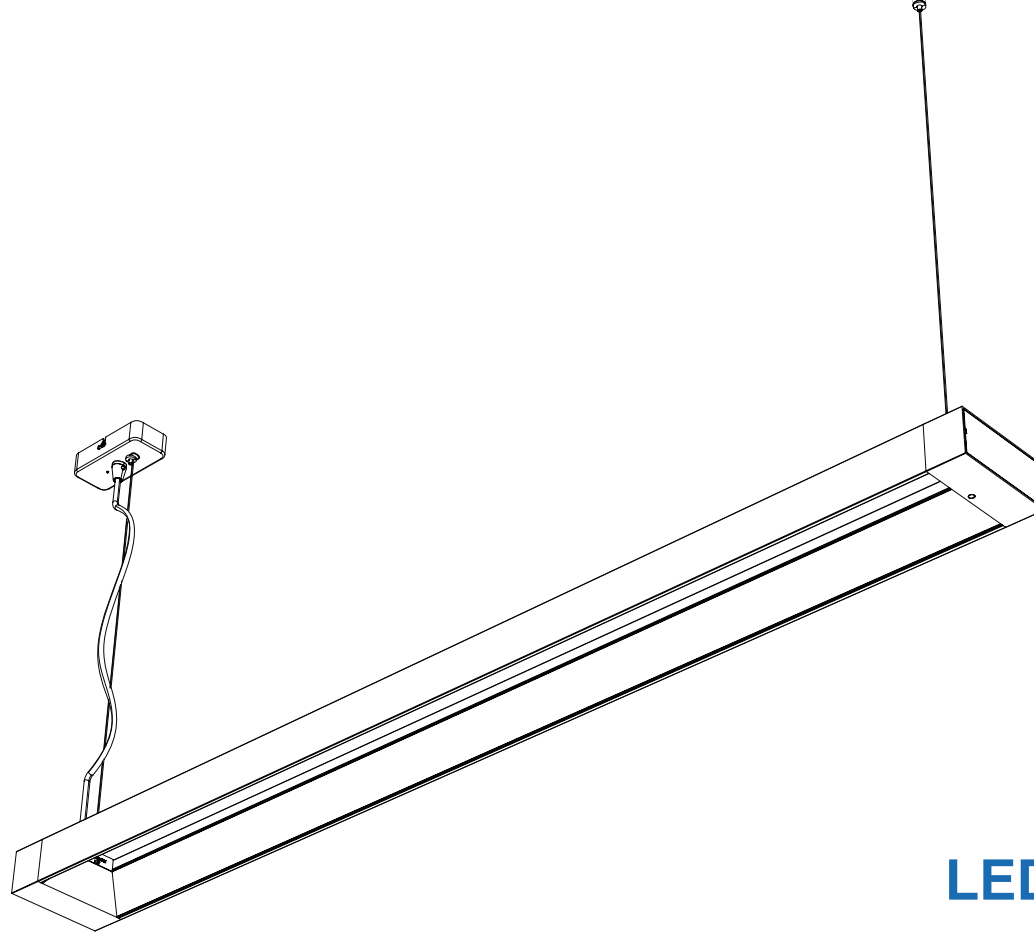

LED Linear Batten Light /Series/

LED batten series and linear light are more and more popular nowadays. The original design concept is to replace the LED tube, but the LED batten is more decorative and elegant, while it also maintains high lumen efficiency. ELWA is committed to the design and development of LED battens. Multiple functions are updated constantly: UGR<19, 100lm/W, 120lm/W, lighting up&down, as well as DALI or 0-10v dimmable system. Surface mounted, suspended and wall mounted are all available.



LED Linear Batten light



DB45 Batten light

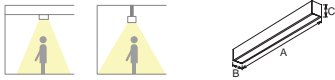

Module changeable design LED batten DB45 provides good heat dissipation, quality light and substantial energy saving. Varies modules can meet different requirements. Suspended, surface mounted and splicing installation optional.

Model	Watt	Size(AxBxCmm)	Lumen(±5)	N.W/pc(kgs)	Q'ty/CTN
DB45A-600-20W	20W	604x60x70	2500lm	1.15	21PCS
DB45A-1200-40W	40W	1204x60x70	5200lm	2.2	20PCS
DB45B-600-20W	20W	604x60x70	2400lm	1.15	21PCS
DB45B-1200-40W	40W	1204x60x70	4800lm	2.2	20PCS

CCT



Finish



DB59 Linear light

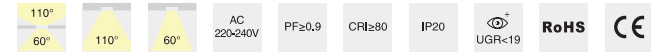

DB59 linear light is a double-side luminaire with hollow design. Opal and grille modules are optional for both sides. The UGR<19 version provides comfortable lighting.

Model	Watt	Size(AxBxCmm)	Lumen(±5)	N.W/pc(kgs)	Q'ty/CTN
DB59A-1200-30W	30W	1200x120x40	4200lm	2.4	5PCS
DB59A-1500-40W	40W	1583x120x40	5600lm	2.8	5PCS
DB59B-1200-30W	30W	1200x120x40	3200lm	2.4	5PCS
DB59B-1500-40W	40W	1583x120x40	4200lm	2.8	5PCS
DB59C-1200-40W	40W	1200x120x40	5000lm	2.4	5PCS
DB59C-1500-60W	60W	1583x120x40	7000lm	2.8	5PCS

CCT



Finish



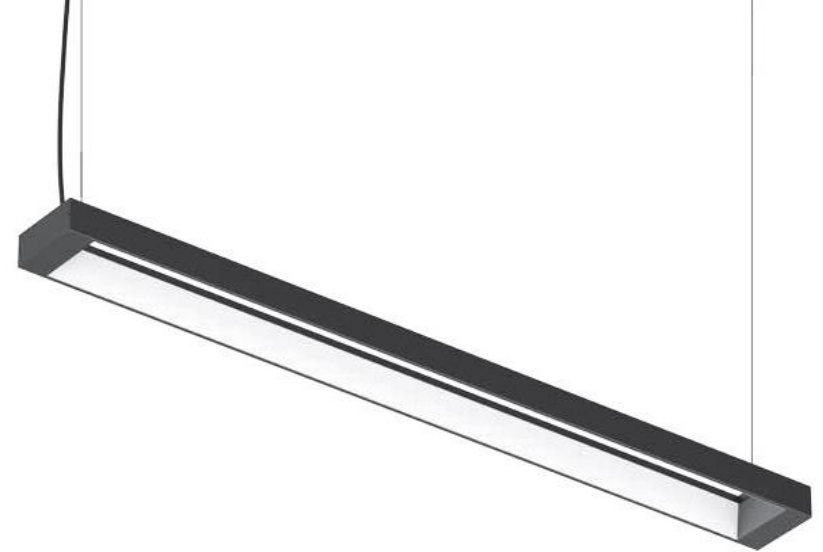

DB60 Linear light

110°
60°

AC 220-240V

PF≥0.9

CRI≥80

IP20

UGR<19

RoHS

CE

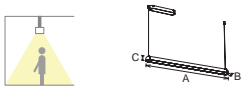

DB60 is a double-side luminaire, with semicircle structure design. The combination of lens and reflector makes luminaire UGR<19.

Model	Watt	Size(AxBxCmm)	Lumen(±5)	N.W/pc(kgs)	Q'ty/CTN
DB60-1200-40W	40W	1206x81x61	4800lm	2.3	6PCS
DB60-1600-60W	60W	1652x81x61	7200lm	2.9	6PCS

CCT



Finish



DB25 Linear light

120°

AC 200-240V

PF≥0.9

CRI≥80

IP20

RoHS

CE

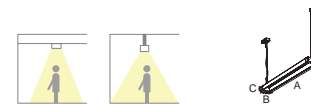

DB25 Linear with suspended and hollow design highlight the brand features, which makes the light goes both up and down sides, The light for up side can reduce the extra light decoration.

Model	Watt	Size(AxBxCmm)	Lumen(±5)	N.W/pc(kgs)	Q'ty/CTN
DB25-900-20W	20W	922x115x48.8	2000lm	1.46	6PCS
DB25-1200-40W	40W	1222x115x48.8	3800lm	1.86	6PCS
DB25-1600-60W	60W	1622x115x48.8	5800lm	2.47	6PCS

CCT



Finish





DB68 Batten light

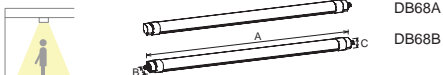

DB68 is an IP66 waterproof IK10 rated luminaire. Adopt 3x2 poles push in wire terminal block. It provides through-wiring for further luminaires (safety class II) connection. Tool free mains cable installation on both sides.

Model	Watt	Size(AxBxCmm)	Lumen(±5)	N.W/pc(kgs)	Q'ty/CTN
DB68A-700-20W	20W	700x78.3x58.6	2300lm	0.5	12PCS
DB68A-1300-40W	40W	1300x78.3x58.6	4680lm	0.8	8PCS
DB68A-1600-50W	50W	1600x78.3x58.6	6000lm	0.95	6PCS
DB68B-700-20W	20W	700x78.3x58.6	2300lm	0.5	12PCS
DB68B-1300-40W	40W	1300x78.3x58.6	4680lm	0.8	8PCS
DB68B-1600-50W	50W	1600x78.3x58.6	6000lm	0.95	6PCS

CCT

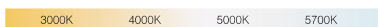

Finish



DB18 Batten light

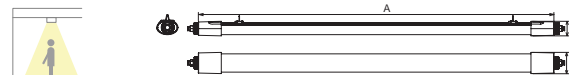

DB18 is a high quality LED batten with high luminous efficacy 115lm/w. With a reliable and robust housing structure (IK10 & IP66). Three size in length (700mm/1300mm/1600mm), and various lumen package, let it to be ideal replacement for traditional fluorescent batten.

Model	Watt	Size(AxBxCmm)	Lumen(±5)	N.W/pc(kgs)	Q'ty/CTN
DB18-700-20W	20W	700x78x53.5	2300lm	0.6	12PCS
DB18-1300-25W	25W	1300x78x53.5	3050lm	0.8	8PCS
DB18-1300-30W	30W	1300x78x53.5	3450lm	0.8	8PCS
DB18-1300-40W	40W	1300x78x53.5	4680lm	0.8	8PCS
DB18-1600-40W	40W	1600x78x53.5	4680lm	1	6PCS
DB18-1600-50W	50W	1600x78x53.5	6000lm	1	6PCS

CCT



Finish





DB31 Batten light



Aluminum lamp body provides excellent heat dissipation. It is made of high lumen 2835 SMD led chip, energy saving, instant start. New plastic snap-on button design for easy installation.

Model	Watt	Size(AxBxCmm)	Lumen(±5)	N.W/pc(kgs)	Q'ty/CTN
DB31-600-20W	20W	600X71X63	2060lm	0.65	12PCS
DB31-1200-40W	40W	1200X71X63	4400lm	1.15	12PCS
DB31-1500-50W	50W	1500X71X63	5500lm	1.35	12PCS

CCT



Finish



DB41 Batten light



DB41 batten lamp adopts separated module design, has been improved to have wider lighting emitting area; color temperature and wattage both switchable. Suspended, surface mounted and splicing installation optional.

Model	Watt	Size(AxBxCmm)	Lumen(±5)	N.W/pc(kgs)	Q'ty/CTN
DB41-600-25W	25W	600x124x68	2500lm	1.5	12PCS
DB41-1200-42W	42W	1200x124x68	4780lm	2.9	6PCS

CCT



Finish





DB49 Batten light

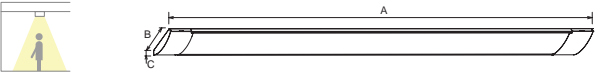

Full size slim batten DB49 featuring uniform light and excellent heat dissipation, CCT changeable by adjusting the slide switch. Easier installation without installing bracket.

Model	Watt	Size(AxBxCmm)	Lumen(±5)	N.W/pc(kgs)	Q'ty/CTN
DB49A-600-20W	20W	600X80X34	2300lm	0.6	10PCS
DB49A-900-30W	30W	900X80X34	3400lm	0.86	10PCS
DB49A-1200-35W	35W	1200X80X34	3900lm	1.12	10PCS
DB49A-1500-40W	40W	1500X80X34	4300lm	1.4	6PCS
DB49B-600-25W	25W	600X124X42	2800lm	0.84	10PCS
DB49B-900-35W	35W	900X124X42	4100lm	1.25	10PCS
DB49B-1200-45W	45W	1200X124X42	5500lm	1.67	10PCS
DB49B-1500-50W	50W	1500X124X42	5500lm	2	6PCS

CCT

3000K 4000K 5000K 5700K

Finish

White Black



AL17-F Batten light

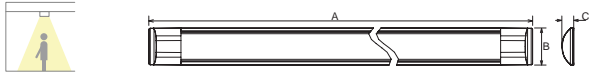

ELWA IP65 weatherproof batten which available in 21W & 42W with size of 600mm and 1200mm. Featuring high grade polycarbonate diffuser and housing, they are suitable for commercial and industrial use where moisture or dust is prevalent.

Model	Watt	Size(AxBxCmm)	Lumen(±5)	N.W/pc(kgs)	Q'ty/CTN
AL17-600-21W	21W	600x75x24	1950lm	0.35	25PCS
AL17-900-32W	32W	900x75x24	2850lm	0.51	25PCS
AL17-1210-42W	42W	1210x75x24	3820lm	0.67	20PCS
AL17F-600-21W	21W	600x78x28	1760lm	0.45	25PCS
AL17F-1210-42W	42W	1210x78x28	3570lm	0.75	25PCS

CCT

3000K 4000K 5000K 5700K

Finish

White Black



DB05 Batten light

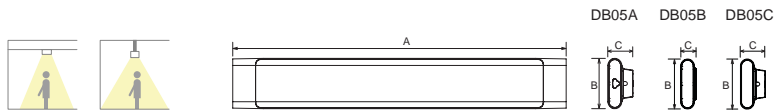

Elegant design, low cost, super slim construction and superior capability, aluminum profile body for good thermal dissipate. Easy installation provided with surface mounted and suspended.

Model	Watt	Size(AxBxCmm)	Lumen(±5)	N.W/pc(kgs)	Q'ty/CTN
DB05A/C-600-20W	20W	600X90X46	1710lm	0.86	12PCS
DB05A/C-900-30W	30W	900X90X46	2630lm	1.3	12PCS
DB05A/C-1200-40W	40W	1200X90X46	3540lm	1.98	12PCS
DB05B-600-20W	20W	600X90X28	1710lm	0.82	12PCS
DB05B-900-30W	30W	900X90X28	2630lm	0.95	12PCS
DB05B-1200-40W	40W	1200X90X28	3540lm	1.5	12PCS

CCT



Finish



DB15 Batten light



DB15 suspending led batten light designed with 270° wide beam angle. Distribute 60% lumens downwards to satisfying the basic requirement for activities and 40% lumens upwards to creating a brilliant lighting atmosphere.

Model	Watt	Size(AxBxCmm)	Lumen(±5)	N.W/pc(kgs)	Q'ty/CTN
DB15-600-20W	20W	600x150x19	1540lm	2.24	6PCS
DB15-900-30W	30W	900x150x19	2400lm	2.86	6PCS
DB15-1200-45W	45W	1200x150x19	3460lm	3.3	6PCS

CCT



Finish





DB08 Batten light



The design of DB08 batten realizes low cost, simple construction and superior capability, milky PC diffuser achieves anti-glare and high light transmittance. It is a high efficient and low cost product with quite large potential market.

Model	Watt	Size(AxBxCmm)	Lumen(±5)	N.W/pc(kgs)	Q'ty/CTN
DB08-600-20W	20W	625X58.5X58.5	2060lm	0.78	10PCS
DB08-1200-40W	40W	1225X58.5X58.5	3960lm	1.5	10PCS
DB08-1500-45W	45W	1525X58.5X58.5	4860lm	1.9	6PCS

CCT



Finish



AL06 Batten light

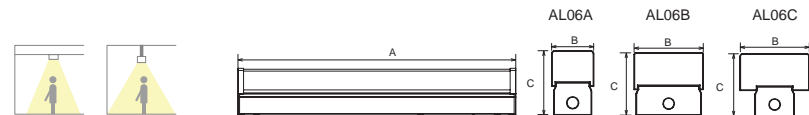

AA12 prismatic diffuser for visual comfort. Cover plate held securely by threaded nut for fast installation. High quality white epoxy powder coated finish. New plastic snap-on end caps for easy installation of diffuser.

Model	Watt	Size(AxBxCmm)	Lumen(±5)	N.W/pc(kgs)	Q'ty/CTN
AL06A-9W	9W	624X69X105	800lm	1.2	12PCS
AL06A-18W	18W	1232X69X105	1630lm	2.4	8PCS
AL06A-25W	25W	1232X69X105	2120lm	3	6PCS
AL06B/C-18W	18W	624X120X108	1630lm	1.8	8PCS
AL06B/C-36W	36W	1232X120X108	3250lm	3.6	4PCS
AL06B/C-50W	50W	1532X120X108	4300lm	4.5	4PCS

CCT



Finish





TRP01/02 Tri-proof light

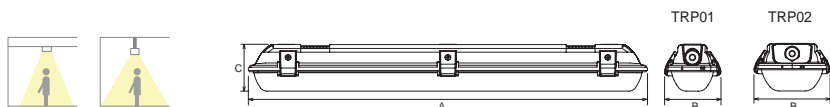

Traditional tube replacement TRP01/02 with high transparency, soft&uniform light distribution; latch design make the lampshade dis-assembly and assembly easier. Dust-proof waterproof rating as IP65. Anti-corrosion, shock resistance, easy cleaning, energy saving and environmental protection.

Model	Watt	Size(AxBxCmm)	Lumen(±5)	N.W/pc(kgs)	Q'ty/CTN
TRP01-600-10W	10W	618x81x74	1050lm	0.85	12PCS
TRP01-1200-20W	20W	1215x81x74	2000lm	1.45	12PCS
TRP01-1500-25W	25W	1515x81x74	2500lm	2.05	12PCS
TRP02-600-20W	20W	618x116x74	2100lm	1.15	8PCS
TRP02-1200-40W	40W	1215x116x74	4200lm	1.95	8PCS
TRP02-1500-50W	50W	1515x116x74	5250lm	2.3	8PCS

CCT



Finish

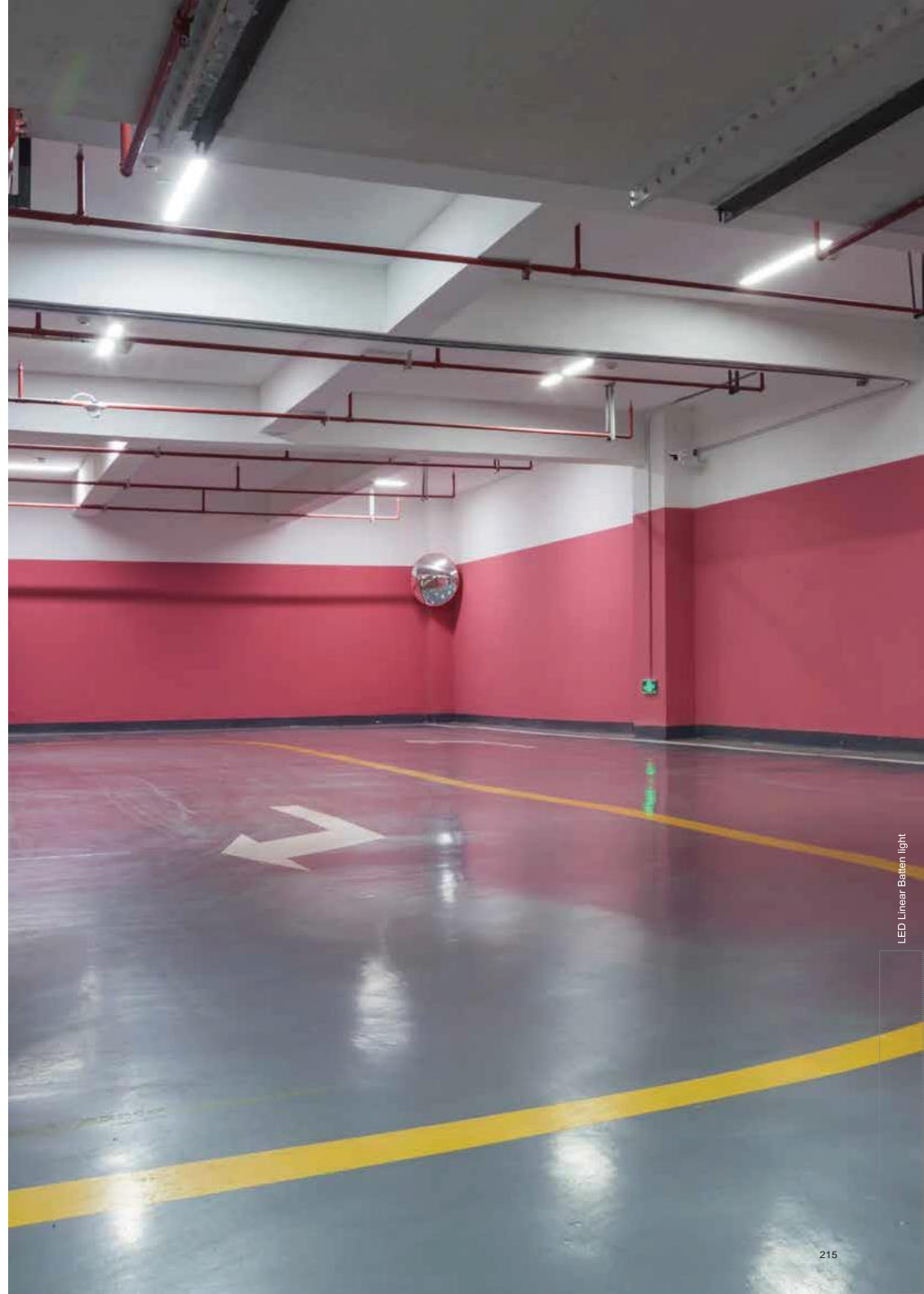



LED Tube Light /Series/

LED tube light more energy saving and high brightness are the first goal we are pursuing of all the time. Generous, simple and practical are what we have been working for. Brand Chip, CRI>80/ 90, high brightness more than 85LM/W, PC cover, Aluminum holder, EMI, EMC passed driver, high light transmittance are the main reason we win our reputation.



T8-AL+PC Tube light

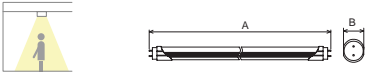

ELWA AL+PC LED Tube light adopts SMD LED with high brightness and slight light decay and V0 fire-rated PC cover, up to 95% light transmittance. Reliable LED driver with branded high quality capacitor and IC solution ensures excellent working performance.

Model	Watt	Size(AxBmm)	Lumen(±5)	N.W/pc(kgs)	Q'ty/CTN
T8-600-10W	10W	603xØ29.3	120lm/W	0.18	25PCS
T8-1200-18W	18W	1211xØ29.3	120lm/W	0.31	25PCS
T8-1500-25W	25W	1514xØ29.3	120lm/W	0.38	25PCS
T8-600-6W	6W	603xØ29.3	150lm/W	0.18	25PCS
T8-1200-12W	12W	1211xØ29.3	150lm/W	0.31	25PCS
T8-1500-15W	15W	1514xØ29.3	150lm/W	0.38	25PCS
T8-600-9W	9W	603xØ28.5	140lm/W	0.18	25PCS
T8-900-10W	10W	907xØ28.5	140lm/W	0.21	24PCS
T8-1200-18W	18W	1211xØ28.5	140lm/W	0.31	25PCS
T8-1500-23W	23W	1514xØ28.5	140lm/W	0.38	25PCS
T8-600-8W	8W	603xØ28.5	160lm/W	0.18	25PCS
T8-900-9W	9W	907xØ28.5	160lm/W	0.21	24PCS
T8-1200-16W	16W	1211xØ28.5	160lm/W	0.31	25PCS
T8-1500-22W	22W	1514xØ28.5	160lm/W	0.38	25PCS
T8-600-7W	7W	603xØ28.5	180lm/W	0.18	25PCS
T8-900-8W	8W	907xØ28.5	180lm/W	0.21	24PCS
T8-1200-14W	14W	1211xØ28.5	180lm/W	0.31	25PCS
T8-1500-18W	18W	1514xØ28.5	180lm/W	0.38	25PCS

CCT

3000K
 4000K
 5000K
 5700K

Finish

White
 Glass



LED Tube light



T8 PC Tube light

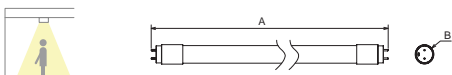

ELWA practical tube T8 adopts complete PC cover, using 2835SMD LED as light source, CRI>80, V0 fire-rated full PC cover ensures high light transmittance and safe installation. No yellowing and cracking.

Model	Watt	Size(AxBmm)	Lumen(±5)	N.W/pc(kgs)	Q'ty/CTN
T8-600-10W-PC	10W	603xØ26	1240lm	0.14	25PCS
T8-1200-18W-PC	18W	1213xØ26	1830lm	0.26	25PCS
T8-1500-20W-PC	20W	1513xØ26	2640lm	0.38	25PCS

CCT



Finish



T8 Glass Tube light

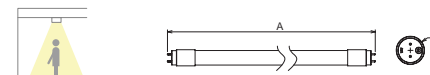

LED Glass Tube is the most practical and economical energy saving design. These glass tubes distribute light in 180° wide beam angle without dark area and provide high lumen output while achieving efficacy over 100 lumens per watt.

Model	Watt	Size(AxBmm)	Lumen(±5)	N.W/pc(kgs)	Q'ty/CTN
T8-600-9W	8W	603xØ28.5	880lm	0.14	25PCS
T8-900-12W	10W	907xØ28.5	1200lm	0.19	25PCS
T8-1200-18W	18W	1213xØ28.5	1770lm	0.26	25PCS
T8-1500-24W	24W	1513xØ28.5	2350lm	0.38	25PCS

CCT



Finish





T6 Tube light



T6 adopts complete PC cover, using 2835SMD LED as light source, CRI>80. V0 fire-rated full PC cover ensures high light transmittance and safe installation. No yellowing and cracking.

Model	Watt	Size(AxBmm)	Lumen(±5)	N.W/pc(kgs)	Q'ty/CTN
T6-1200-25W	25W	1213xØ23.3	3250lm	0.22	25PCS
T6-1500-25W	22W	1513xØ23.3	3200lm	0.3	25PCS

CCT



Finish



T5-E Tube light

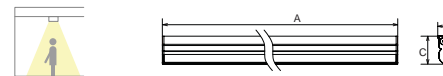
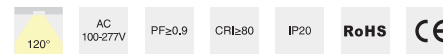

Complete PC LED tube T5 is a successful low-cost design; V0 fire-rated PC housing provides safe and portable installation. Independent switch makes it more convenient and flexible in use.

Model	Watt	Size(AxBxCmm)	Lumen(±5)	N.W/pc(kgs)	Q'ty/CTN
T5-600-8W	8W	578x22x34.5	750lm	0.15	50PCS
T5-900-10W	10W	878x22x34.5	1280lm	0.19	25PCS
T5-1200-18W	18W	1178x22x34.5	1890lm	0.24	25PCS

CCT



Finish



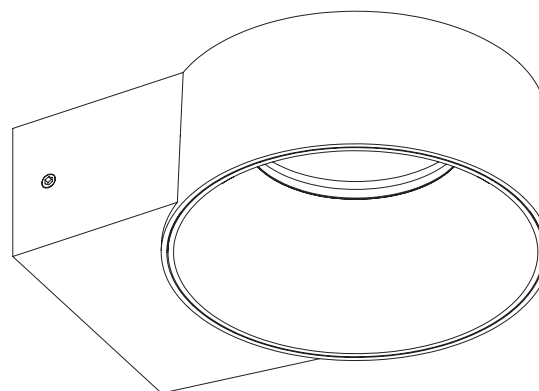

LED Wall & Spike Light /Series/

ELWA has been developing a series of wall lights and spike lights in recent years. More and more fashionable and brilliant products are self-designed. Equipped with new sensor function, up and down lighting, beam angle adjustable version and IP65 waterproof, ELWA led wall light family provide various solutions for project and distribution. All wall lights can be used for both indoor corridors and outdoor courtyards. ELWA has received many good reviews from our customers.

WL16 Wall lamp

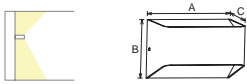

IP54 waterproof WL16 LED wall lamp adopts traditional classical design to meet the public aesthetic view, the up and down structure distributes perfect lighting effects; ADC12 housing material provides excellent thermal management and 94-V0 fire rated PC make sure softly lighting to creating comfortable atmosphere.

Model	Watt	Size(AxBxCmm)	Lumen(±5)	N.W/pc(kgs)	Q'ty/CTN
WL16-1510-10W	10W	150x100x92	500lm	0.54	24PCS
WL16-3010-18W	18W	300x100x92	900lm	1.05	12PCS

CCT



Finish



WL20 Wall lamp



IP65 waterproof WL20 wall lamp adopts ADC12 aluminum housing which can provide excellent thermal management; it also with unique up and down light functional design ; the beam angle can be adjusted by the flexible aluminum plate.

Model	Watt	Size(AxBxCmm)	Lumen(±5)	N.W/pc(kgs)	Q'ty/CTN
WL20-10W	10W	120x96.8x100	900lm	0.59	18PCS
WL20-18W	18W	242x97.7x100	1350lm	1.1	12PCS

CCT



Finish



AL65 Bulkhead



IP65 IK10 AL65 bulkhead adopts Die-casting aluminum body and 94-V0 fire-rated PC cover. This fixture provides an alternative to the color changeable and Emergency function. These lights are a perfect answer to complete your outdoor look.

Model	Watt	Size(AxBxCmm)	Lumen(±5)	N.W/pc(kgs)	Q'ty/CTN
AL65-10-12W	12W	Ø250x58x229	1250lm	1.05	10PCS
AL65-10-18W	18W	Ø250x58x229	1850lm	1.15	10PCS

CCT



Finish



AL66 Bulkhead



IP65 IK10 AL66 bulkhead adopts Die-casting aluminum body and 94-V0 fire-rated PC cover. This fixture provides an alternative to the color changeable and Emergency function. These lights are a perfect answer to complete your outdoor look.

Model	Watt	Size(AxBxCmm)	Lumen(±5)	N.W/pc(kgs)	Q'ty/CTN
AL66-10-12W	12W	Ø250x74x143	1100lm	1.1	10PCS

CCT



Finish



WL06A Wall lamp

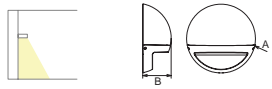
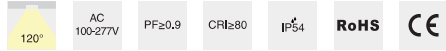

WL06A led wall light impresses with its unique smile design as well as the tactile appeal. Smiley-face design on the wall makes everyone feel warm and cozy. IP54 rating for indoor and outdoor wall lighting. It is a green and environmentally friendly lighting product.

Model	Watt	Size(AxBxCmm)	Lumen(±5)	N.W/pc(kgs)	Q'ty/CTN
WL06A-12W	12W	Ø159x65.5	1050lm	0.35	36PCS

CCT



Finish



WL06B Wall lamp

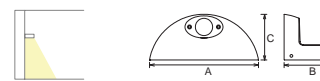

WL06B led wall light impresses with its unique eyes design as well as the tactile appeal. Smiley-face design on the wall makes everyone feel warm and cozy. IP54 rating for indoor and outdoor wall lighting. It is a green and environmentally friendly lighting product.

Model	Watt	Size(AxBxCmm)	Lumen(±5)	N.W/pc(kgs)	Q'ty/CTN
WL06B-12W	12W	158x70x66.5	1100lm	0.295	36PCS

CCT



Finish



WL07 Wall lamp

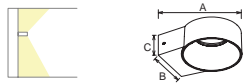

WL07 LED wall light provides a stylish architectural luminaire for interior applications by the unique form and double-sided light functional design. It adopts hollow cone-shaped opal PC diffuser and is an ideal replacement for traditional Halogen or fluorescent wall lights.

Model	Watt	Size(AxBxCmm)	Lumen(±5)	N.W/pc(kgs)	Q'ty/CTN
WL07-8W	8W	170x140x59	655lm	0.485	24PCS

CCT



Finish



WL08 Wall lamp

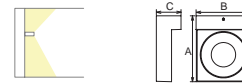

WL08 LED wall light adopts hollow cone-shaped opal PC diffuser and aluminum housing which provides excellent thermal management, 94-V0 fire rated PC distributes softly lighting to creating comfortable atmosphere.

Model	Watt	Size(AxBxCmm)	Lumen(±5)	N.W/pc(kgs)	Q'ty/CTN
WL08-8W	8W	139x115x52	670lm	0.415	24PCS

CCT



Finish



ML08 Garden light

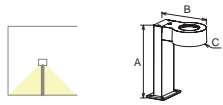

ML08 LED garden light provides a stylish architectural luminaire with double-sided light design. IP65 waterproof is suitable for outside garden. The holder length is optional among 300mm, 500mm, 700mm, and 1000mm.

Model	Watt	Size(AxBxCmm)	Lumen(±5)	N.W/pc(kgs)	Q'ty/CTN
ML08-300-8W	8W	300x208xØ140	655lm	1.3	6PCS
ML08-500-8W	8W	500x208xØ140	655lm	1.72	6PCS
ML08-700-8W	8W	700x208xØ140	655lm	2.15	6PCS
ML08-1000-8W	8W	1000x208xØ140	655lm	2.62	6PCS

CCT



Finish



ML07 Spike light

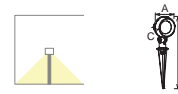

LED Spike light adopts integrated COB light source of fashion design, equipped with high lumen, high CRI, low temperature and long lifespan. The AC/DC12V input provides more safety guarantee. It applies to landscaping embellishment lighting for residence and community and all kind of parks.

Model	Watt	Size(AxBxCmm)	Lumen(±5)	N.W/pc(kgs)	Q'ty/CTN
ML07-6W	6W	Ø76x262x57.5	550lm	0.31	21PCS
ML07-10W	10W	Ø76x262x57.5	950lm	0.31	21PCS

CCT



Finish



ML06 Spike light

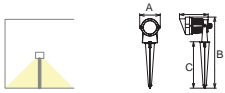

LED Spike light adopts aluminum body and plastic spike for damp conditions. The AC/DC12V input provides more safety guarantee. It applies to landscaping embellishment lighting for residence and community and all kind of parks.

Model	Watt	Size(AxBxCmm)	Lumen(±5)	N.W/pc(kgs)	Q'ty/CTN
ML06-6W	6W	Ø72x243x97	360lm	0.24	50PCS

CCT



Finish



Black

WL02 Step light



WL02 LED Step Light is a simple and generous lamps, widely used for corridor, stairway, basement, carport application, and the most appropriate mounting height is 0.3m up to ground. There are 4 sizes, users can choose according to specific demand.

Model	Watt	Size(AxBxCmm)	Cut-out(mm)	Lumen(±5)	N.W/pc(kgs)	Q'ty/CTN
WL02-7070-3W	3W	70x70x24	60x60	220lm	0.22	50PCS
WL02-11070-3W	3W	110x70x27	100x60	220lm	0.3	40PCS
WL02-20070-3W	3W	200x70x32	190x60	220lm	0.45	24PCS
WL02-200135-8W	8W	200x135x32	190x125	580lm	0.66	24PCS

CCT



Finish



White

WL01 Wall lamp



Single head and double-head wall lamp comprises a bottom seat and a lamp body for options. The rotatable double-head LED wall lamp is simple and reasonable in structure, low in production cost, convenient to mount and use and good in heat dissipation. Microwave sensor is also available.

Model	Watt	Size(AxBmm)	Lumen(±5)	N.W/pc(kgs)	Q'ty/CTN
WL01-8W	8W	Ø76x133	760lm	0.7	12PCS
WL01-13W	13W	Ø76x133	1145lm	0.58	12PCS
WL01-16W	16W	Ø76x133	1520lm	0.94	12PCS
WL01-26W	26W	Ø76x133	2240lm	0.94	12PCS

CCT



Finish



Black

WL11 Wall lamp

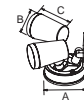

IP65 WL11 LED wall lamp is available for PIR sensor adjusting the lux and duration Time, a great choice for outdoor walkways, garage areas, and back door entrances etc. It allows one head & two heads; the ADC12 heat sink makes the excellent heat dissipation; internal isolated driver ensures the safety and saves the space.

Model	Watt	Size(AxBxCmm)	Lumen(±5)	N.W/pc(kgs)	Q'ty/CTN
WL11-8W	8W	Ø100x60.5x87	800lm	0.45	18PCS
WL11-16W	16W	Ø100x60.5x87	1600lm	0.72	18PCS

CCT



Finish



Black

ML01 Mirror light



ML01 Mirror light adopts high transmittance PC lampshade, concise and elegant design as well as exquisite details create a sense of stylish. Interchangeable CCT by slide switch is available.

Model	Watt	Size(AxBxCmm)	Lumen(±5)	N.W/pc(kgs)	Q'ty/CTN
ML01-580-10W	10W	580x41x111	1180lm	0.66	12PCS
ML01-860-15W	15W	860x41x111	1950lm	0.87	12PCS
ML01-1140-20W	20W	1140x41x111	2430lm	1.03	12PCS

CCT



Finish



ML03 Mirror light



ML03 Mirror light enables high lumen 140lm/W. Three dimensions for optional: 600mm, 750mm, 900mm, 1200mm. Built-in flicker free driver and whole body with IP54 waterproof.

Model	Watt	Size(AxBxCmm)	Lumen(±5)	N.W/pc(kgs)	Q'ty/CTN
ML03-600-7.8W	7.8W	591x55x21.5	1092lm	0.425	20PCS
ML03-750-7.8W	7.8W	741x55x21.5	1092lm	0.505	20PCS
ML03-900-8.5W	8.5W	891x55x21.5	1190lm	0.625	16PCS
ML03-1200-9.5W	9.5W	1191x55x21.5	1330lm	0.765	12PCS

CCT



Finish



ML13 Mirror light







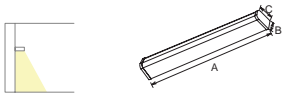

ML13 mirror light enables high lumen 120lm/W. Anti-glare diffuser design provides uniform and comfortable light. Built-in driver and whole body with IP54 waterproof. Microwave sensor & CCT changeable are available.

Model	Watt	Size(AxBxCmm)	Lumen(±5)
ML13-450-8W	8W	450x61x77	960lm
ML13-600-12W	12W	600x61x77	1440lm
ML13-900-15W	15W	900x61x77	1800lm

CCT



Finish





LED Spot Light /Series/

LED spotlights are typical modern lighting without main lights and fixed scale, which can create perfect atmosphere. ELWA spotlight series has good quality, soft and elegant lighting output, which can also be used for local lighting. Commonly used GU10 and MR16 base, various types to meet the different needs from customers.

SP91/92 Spot light

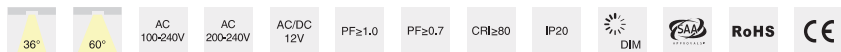

LED Spotlight adopts COB LED, with high brightness and slight light decay. Excellent heat dissipation with aluminum heatsink and good color rendering index up to 80. MR16, GU10, E26 and E27 base available, easy installation, 36°/60° beam angle for optional. with direct replacement of the traditional halogen. Dimmable version in GU10 & E26 & E27 available, great compatibility to worldwide famous dimmers.

Model	Watt	Size(AxBmm)	Lumen(±5)	N.W/pc(kgs)	Q'ty/CTN
SP91-GU10-6W	6W	Ø50x74	320lm	0.075	100PCS
SP91-MR16-6W	6W	Ø50x67.5	325lm	0.075	100PCS
SP92-GU10-9W	9W	Ø50x87	535lm	0.105	100PCS
SP92-MR16-9W	9W	Ø50x83	535lm	0.105	100PCS

CCT



Finish



SP77 Spot light

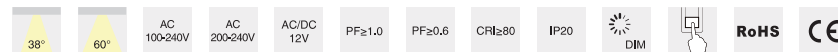

LED Spotlight adopts COB LED, with high brightness and slight light decay. Excellent heat dissipation with aluminum heatsink and good color rendering index up to 80. MR16, GU10, E26 and E27 base available, easy installation, 30°/45° beam angle for optional. with direct replacement of the traditional halogen. Dimmable version in GU10 & E26 & E27 available, great compatibility to worldwide famous dimmers.

Model	Watt	Size(AxBmm)	Lumen(±5)	N.W/pc(kgs)	Q'ty/CTN
SP77-GU10-4W	4W	Ø50x56	320lm	0.05	100PCS
SP77-GU10-6W	6W	Ø50x74	460lm	0.075	100PCS
SP77-GU10-8W	8W	Ø50x87	750lm	0.115	100PCS
SP77-MR16-4W	4W	Ø50x49	340lm	0.045	100PCS
SP77-MR16-6W	6W	Ø50x68	460lm	0.065	100PCS
SP77-MR16-8W	8W	Ø50x81	750lm	0.105	100PCS

CCT



Finish



SP43 Spot light

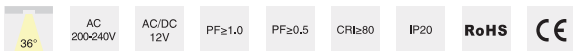

LED Spotlight with unique and stylish design. Excellent heat dissipation with aluminum heatsink, 36° beam angle, MR16, GU10 base available, easy installation, with direct replacement of the traditional 50W halogen lamp.

Model	Watt	Size(AxBmm)	Lumen(±5)	N.W/pc(kgs)	Q'ty/CTN
SP43-GU10-5W	5W	Ø50x52.5	365lm	0.04	100PCS
SP43-GU10-5.4W	5.4W	Ø50x52.5	365lm	0.04	100PCS
SP43-MR16-5W	5W	Ø50x45	370lm	0.035	100PCS
SP43-MR16-5.4W	5.4W	Ø50x45	370lm	0.035	100PCS

CCT



Finish



SP51 Spot light

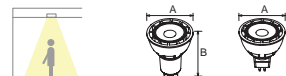

SP51 LED Spotlight with unique and stylish design. Excellent heat dissipation with aluminum heatsink, 30°/45° beam angle for optional. MR16, GU10 base available, easy installation, with direct replacement of the traditional 50W halogen lamp.

Model	Watt	Size(AxBmm)	Lumen(±5)	N.W/pc(kgs)	Q'ty/CTN
SP51-GU10-4W	4W	Ø50x58	410lm	0.055	100PCS
SP51-GU10-5.4W	5.4W	Ø50x58	525lm	0.055	100PCS
SP51-MR16-4W	4W	Ø50x51.5	460lm	0.05	100PCS
SP51-MR16-5.4W	5.4W	Ø50x51.5	545lm	0.05	100PCS

CCT



Finish



SP48 Spot light



LED Spotlight with unique and stylish design. Excellent heat dissipation with aluminum heatsink, 36° beam angle, MR16, GU10 base available, easy installation, with direct replacement of the traditional 50W halogen lamp.

Model	Watt	Size(AxBmm)	Lumen(±5)	N.W/pc(kgs)	Q'ty/CTN
SP48-GU10-7W	7W	Ø50x60	645lm	0.055	100PCS

CCT



Finish



SP57 Spot light

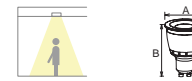

SP57 spot light adopts SMD and RGB chips, adds bluetooth and remote control modules, Easy and convenient to control APP, support IOS/Android bluetooth 4.0 BLE protocol. Integrated design makes the installation easier.

Model	Watt	Size(AxBmm)	Lumen(±5)	N.W/pc(kgs)	Q'ty/CTN
SP57-GU10-5W-B3	5W	Ø50x67	350lm	0.085	100PCS

CCT



Finish



V25 Spot light



LED Spotlight with unique and stylish design. Excellent heat dissipation with aluminum heatsink, 36° beam angle, MR16, GU10 base available, easy installation, with direct replacement of the traditional 50W halogen lamp.

Model	Watt	Size(AxBmm)	Lumen(±5)	N.W/pc(kgs)	Q'ty/CTN
V25-10W	10W	Ø50x80	655lm	0.24	50PCS

CCT



Finish

