











































ICON INDEX

		
Recessed installation	Surface mounted installation	Surface mounted installation (Up&down)
		
Suspended installation (Up&down)	Suspended installation (Down)	Wall mounted (Down)
		
Wall mounted (Up&down)	Wall mounted (Up)	Wall mounted
		
Track installation	Spike light installation	

xxxxK xxxxK xxxxK xxxxK
Color temperature

	Beam Angle		Emergency Function
	Voltage		Slide Switch Power Changeable Function
	Power Factor		Smart Lighting
	CRI		Unified Glare Rating
	Ingress Protection		Wall Switch CCT Changeable Function
	Dimmable		RGB Color Adjustable Function
	DALI Dimmable		Slide Switch CCT Changeable Function
	0-10V Dimmable		Tunable White
	Flicker Free		Dim to Warm
	2.4G Intelligent Control		Coverable by Insulation Material
	Wifi Intelligent Control		Standard Deviation Colour Matching
	Remote Control		Classification TP(a)
	PIR Sensor Control		Classification TP(b)
	Bluetooth Control		Horizontal Rotation
	Music Functionality		Vertical Rotation
	Microwave Sensor Function		

CONTENTS

338 Series P02-09

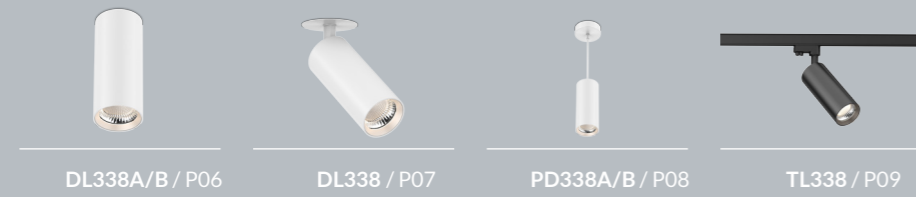

DL338A/B / P06

DL338 / P07

PD338A/B / P08

TL338 / P09

338D Series P10-13



NEW DL338D / P12

NEW TL338D / P13

228 Series P14-21



DL228A / P18

DL228B / P19

PD228 / P20

TL228 / P21

284 Series P22-29



DL284A/B / P26

DL284C / P27

DL284A/B / P28

DL284C / P29

332 Series P30-37



DL332A / P34

DL332B / P35

TL332A / P36

TL332B / P37

340 Series P38-43



DL340 / P42

TL340 / P43

382 Series P44-49



NEW DL382A / P46

NEW TL382A / P47

NEW ACC TL/DL338B / P48

365 Series P50-53



DL365 / P52

TL365 / P53

383 Series P54-57



NEW DL383 / P56

NEW TL383 / P57

LED DOWNLIGHT Ultrathin Series P60-89



DL367 / P60

DL210 / P62

DL216 / P63

DL97 / P64

CL59 / P65

DL110 / P66

DL317 / P67

DL161 / P68

NEW DL308B / P70

DL34 / P71

DL96 / P72

DL105 / P73

NEW DL137 / P74

CL22 / P75

DL147C / P76

DL147F / P77

DL141 / P78

DL359 / P80

DL190 / P82

DL150 / P83

CL88 / P84

CL30 / P85

DL368 / P86

DL248A / P88

DL248B / P89

LED DOWNLIGHT Integrated Series P90-110



LED DOWNLIGHT COB Series P114-201



LED DOWNLIGHT Deep-down Series P202-219



LED DOWNLIGHT Surface mounted & Pendant Series P220-254

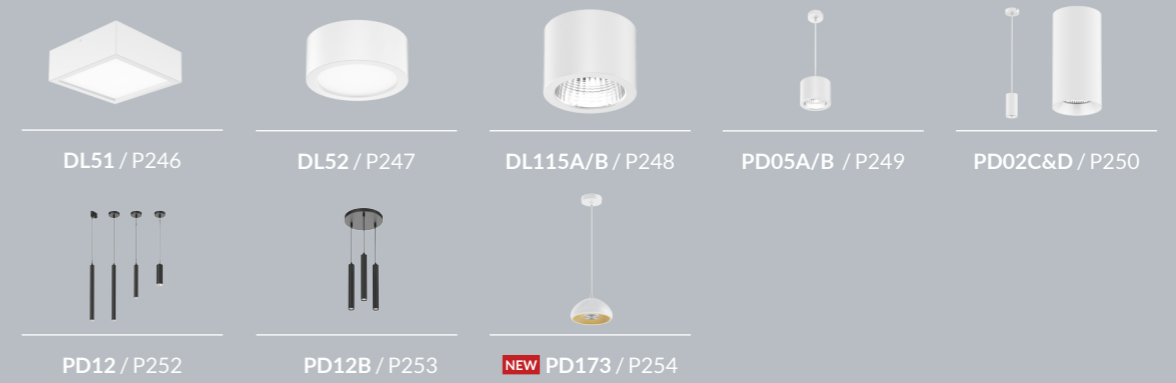
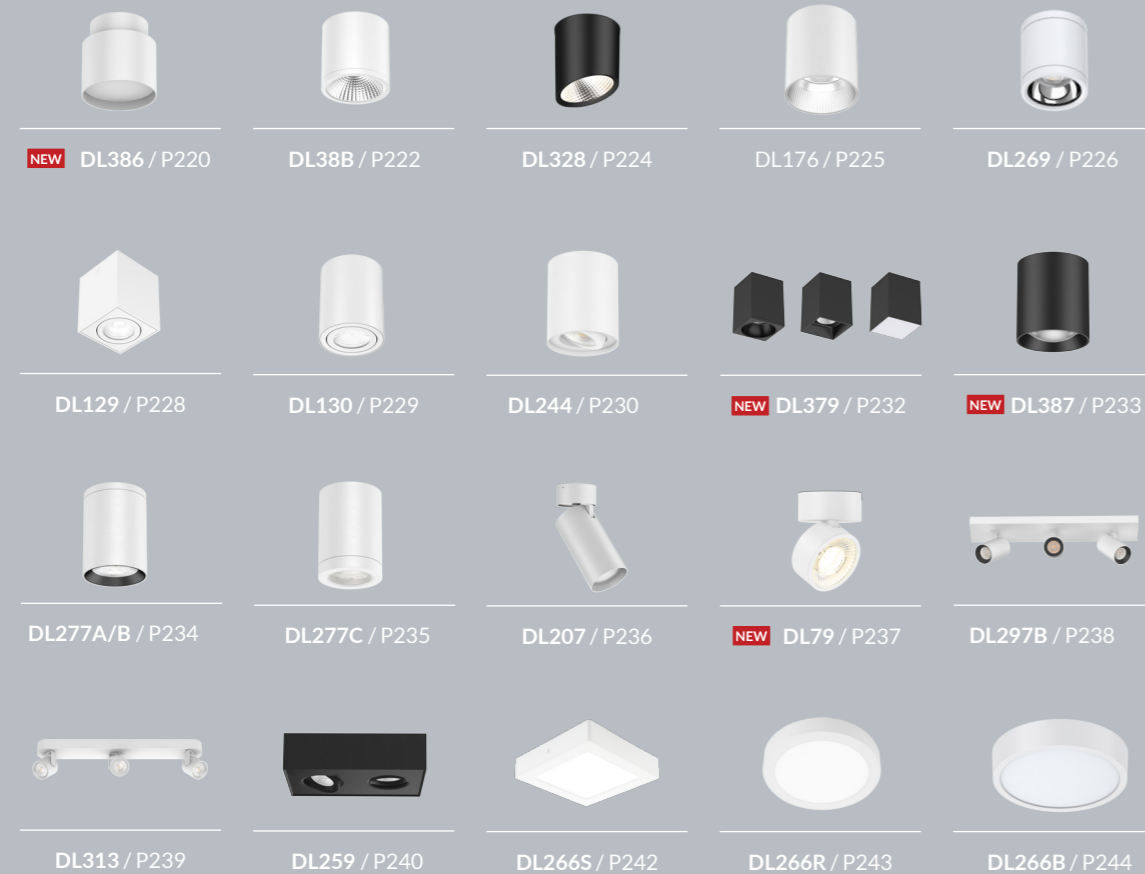

LED CEILING LIGHT & LED BULKHEAD P258-321





LED TRACK LIGHT P324-368



LED PANEL LIGHT P386-420

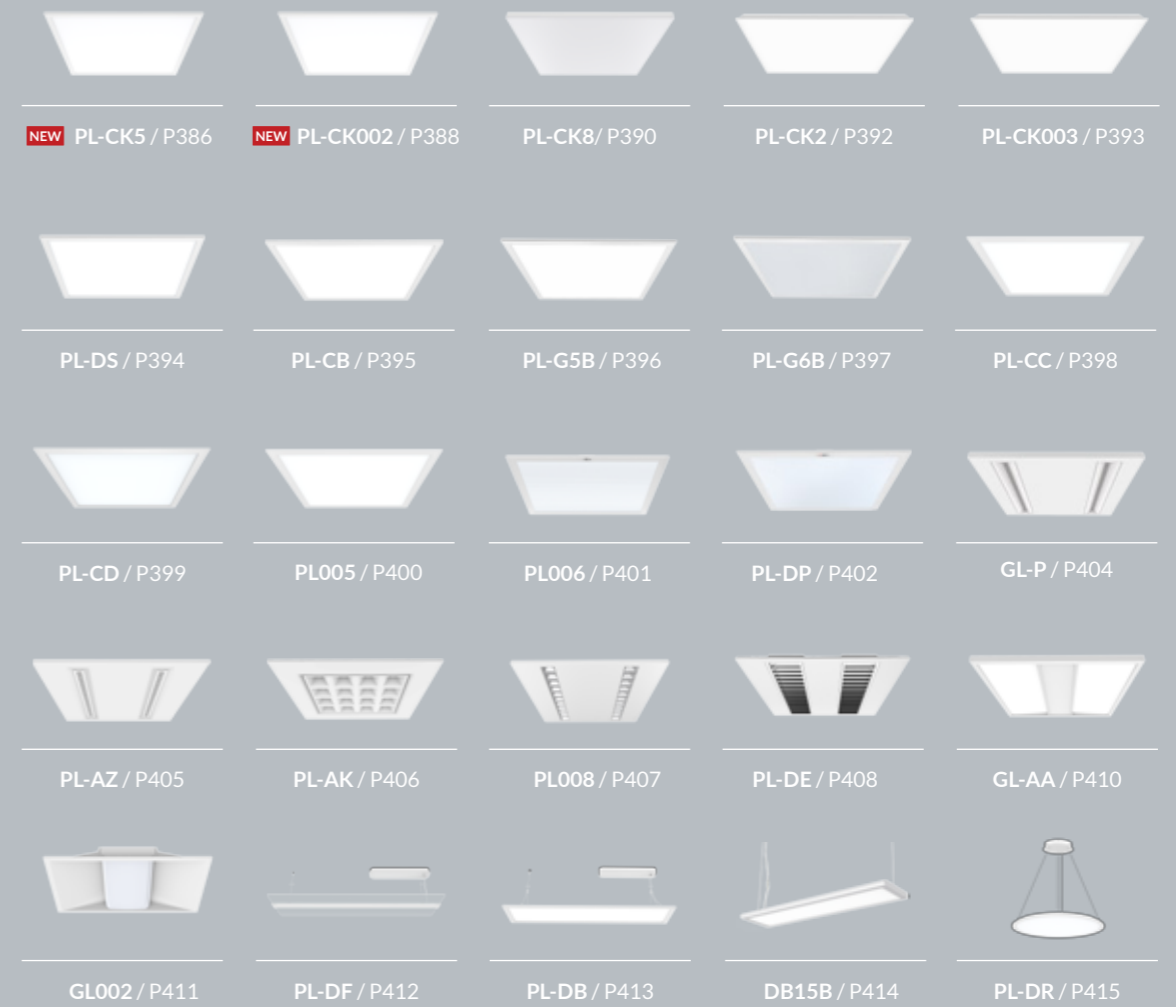



PL-DG / P416

PL-W / P418

PL-DD / P419

PL-EA / P420

LED FREESTANDING LUMINAIRE P424-428

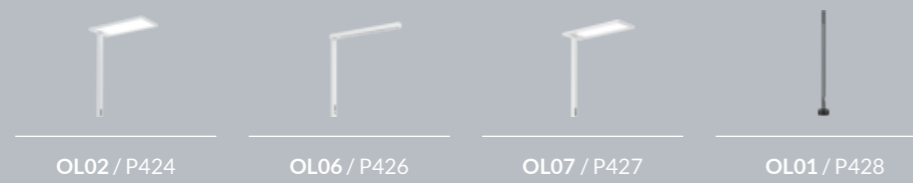

OL02 / P424

OL06 / P426

OL07 / P427

OL01 / P428

LED LINEAR & BATTEN LIGHT P432-488

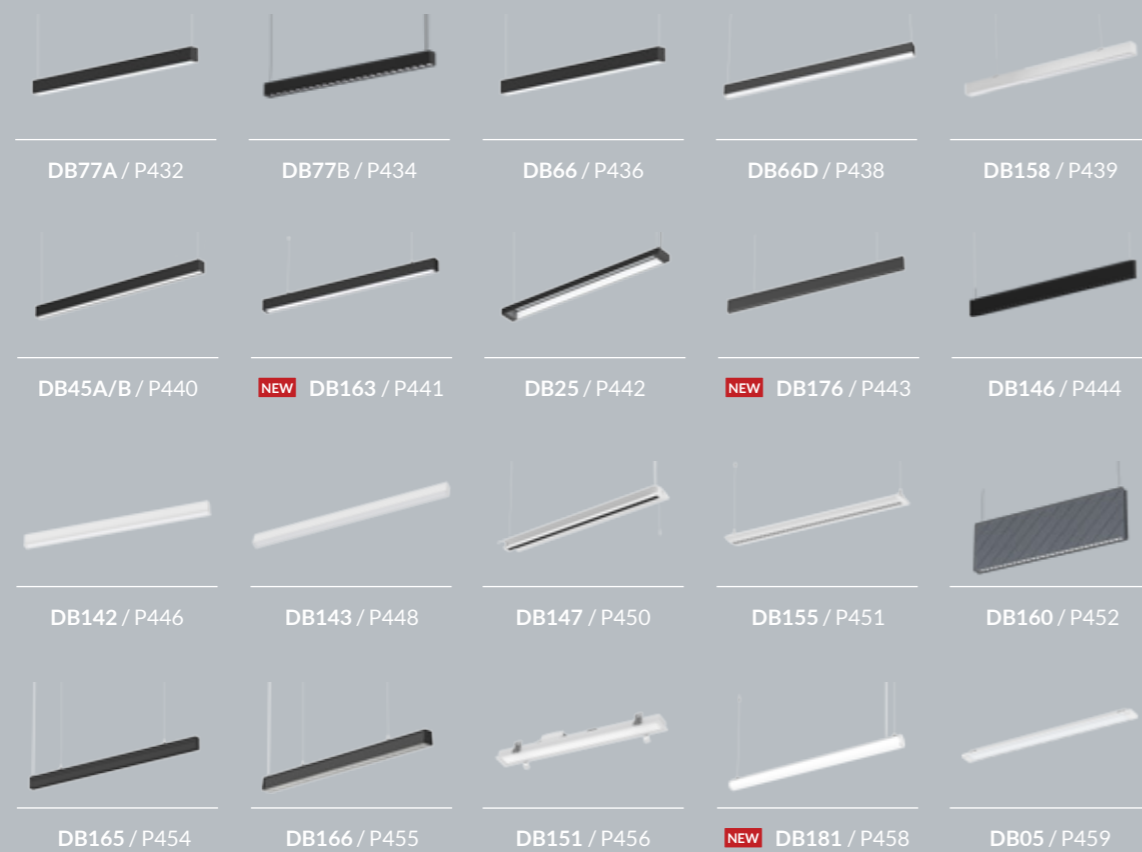

DB77A / P432

DB77B / P434

DB66 / P436

DB66D / P438

DB158 / P439

DB45A/B / P440

NEW DB163 / P441

DB25 / P442

NEW DB176 / P443

DB146 / P444

DB142 / P446

DB143 / P448

DB147 / P450

DB155 / P451

DB160 / P452

DB165 / P454

DB166 / P455

DB151 / P456

NEW DB181 / P458

DB05 / P459

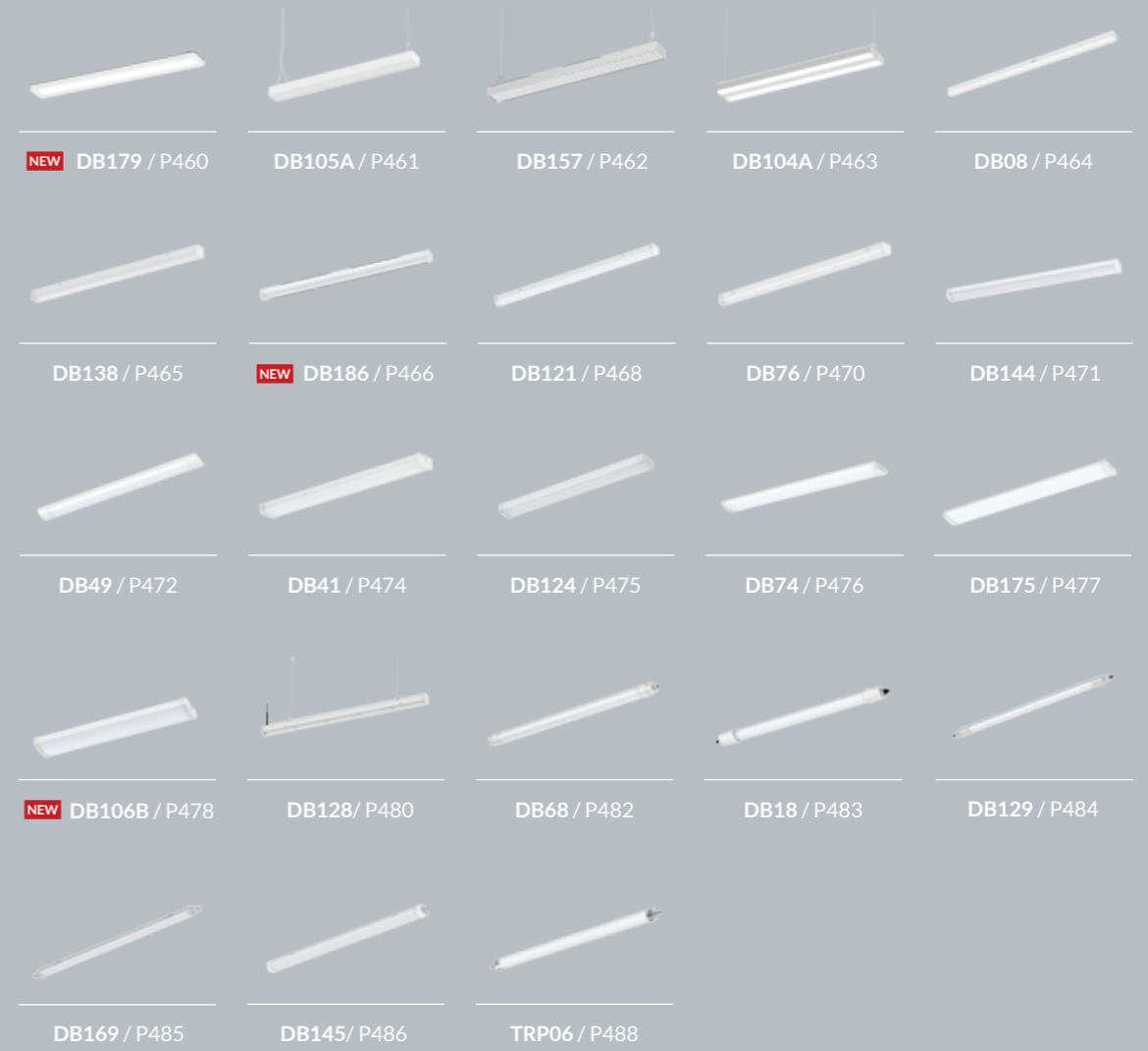

NEW DB179 / P460

DB105A / P461

DB157 / P462

DB104A / P463

DB08 / P464

DB138 / P465

NEW DB186 / P466

DB121 / P468

DB76 / P470

DB144 / P471

DB49 / P472

DB41 / P474

DB124 / P475

DB74 / P476

DB175 / P477

NEW DB106B / P478

DB128 / P480

DB68 / P482

DB18 / P483

DB129 / P484

DB169 / P485

DB145 / P486

TRP06 / P488

LED WALL & SPIKE LIGHT & MIRROR LIGHT P492-581



WL28 / P492

WL28B/C / P493

WL85 / P494

WL07C / P495

WL73 / P496

WL90A/B / P498

WL20 / P499

NEW WL153 / P500

WL88 / P501

WL16 / P502



LED TUBE LIGHT P584-587



338 Series

UGR<19



Track light
TL338



Suspension
PD338B



Suspension
PD338A



Recessed
DL338



Surface mounted
DL338A



Track spot surface
DL338B

DIY MODULAR DESIGN



Lamp body

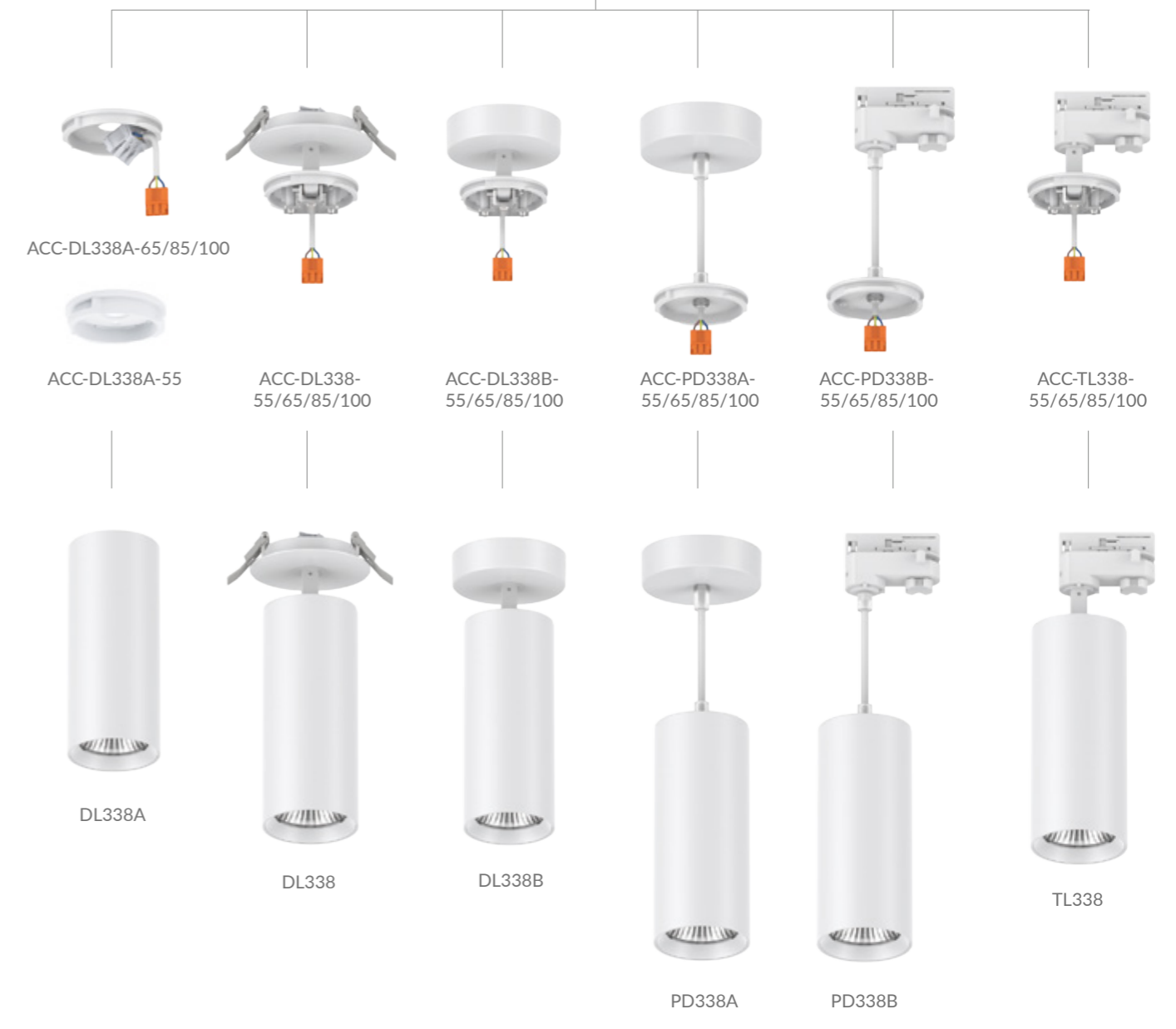

Four size options



Replaceable reflector (front trim is not exchangeable)



3-CCT changeable

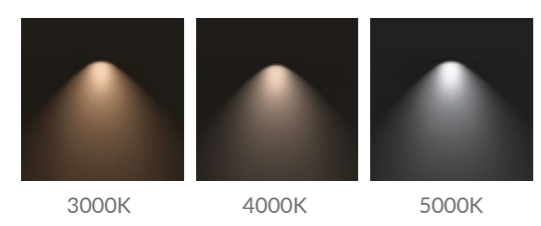

Power adjustable

Ø65mm :10W/12W/15W
 Ø85mm :15W/20W/25W
 Ø100mm :25W/30W/35W



DL338A



DL338B



DL338A/B Downlight

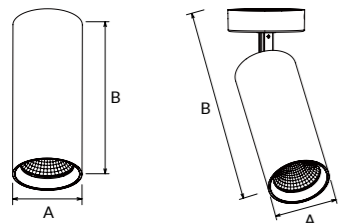

DL338A/B is a DIY modular series with an exquisite appearance and anti-glare UGR19 design, 6 kinds of installation ways, 3 reflectors and 3 front ring colors can be exchangeable. It adopts brand Bridgelux COB led chip with 120lm/W light efficiency, AL6063 Aluminum profile provides excellent thermal dissipation. Four size options : Ø55mm, Ø65mm, Ø85mm, Ø100mm. It can do triac dim, DALI dim, CCT interchangeable and wattage adjustable.

- ▶
- ▶
- ▶
- ▶
- ▶

Code	Watt	Size(AxBmm)	Lumen(±5%)	N.W/pc(kgs)	Q'ty/CTN
DL338A/B-55-6W	6W	Ø55x160/Ø55x211	750lm	0.33/0.49	24PCS
DL338A/B-55-10W	10W	Ø55x160/Ø55x211	1200lm	0.33/0.49	24PCS
DL338A/B-65-10W	10W	Ø65x180/Ø65x231	1200lm	0.44/0.60	24PCS
DL338A/B-65-15W	15W	Ø65x180/Ø65x231	1750lm	0.44/0.60	24PCS
DL338A/B-85-20W	20W	Ø85x206/Ø85x270	2650lm	0.73/0.89	12PCS
DL338A/B-85-25W	25W	Ø85x206/Ø85x270	3200lm	0.73/0.89	12PCS
DL338A/B-100-30W	30W	Ø100x220/Ø100x284	3650lm	0.99/1.15	12PCS
DL338A/B-100-35W	35W	Ø100x220/Ø100x284	4250lm	0.99/1.15	12PCS

CCT — 2700K — 3000K — 4000K — 5000K

Finish — White Black

DL338 Downlight

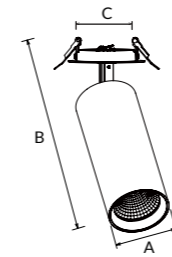

DL338 is a DIY modular series with an exquisite appearance and anti-glare UGR19 design, 6 kinds of installation ways, 3 reflectors and 3 front ring colors can be exchangeable. It adopts brand Bridgelux COB led chip with 120lm/W light efficiency, AL6063 Aluminum profile provides excellent thermal dissipation. Four size options : Ø55mm, Ø65mm, Ø85mm, Ø100mm. It can do triac dim, DALI dim, CCT interchangeable and wattage adjustable.

- ▶
- ▶
- ▶
- ▶
- ▶

Code	Watt	Size(AxBmm)	Cut-out(mm)	Lumen(±5%)	N.W/pc(kgs)	Q'ty/CTN
DL338-55-6W	6W	Ø55x215	90-95	750lm	0.51	12PCS
DL338-55-10W	10W	Ø55x215	90-95	1200lm	0.51	12PCS
DL338-65-10W	10W	Ø65x235	90-95	1200lm	0.62	12PCS
DL338-65-15W	15W	Ø65x235	90-95	1750lm	0.62	12PCS
DL338-85-20W	20W	Ø85x274	90-95	2650lm	1.08	12PCS
DL338-85-25W	25W	Ø85x274	90-95	3200lm	1.08	12PCS
DL338-100-30W	30W	Ø100x288	90-95	3650lm	1.17	12PCS
DL338-100-35W	35W	Ø100x288	90-95	4250lm	1.17	12PCS

CCT — 2700K — 3000K — 4000K — 5000K

Finish — White Black



PD338A/B Downlight

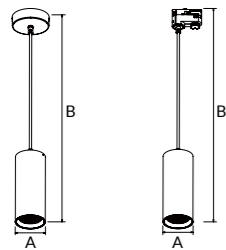

PD338A/B is a DIY modular series with an exquisite appearance and anti-glare UGR19 design, 6 kinds of installation ways, 3 reflectors and 3 front ring colors can be exchangeable. It adopts brand Bridgelux COB led chip with 120lm/W light efficiency, AL6063 Aluminum profile provides excellent thermal dissipation. Four size options : Ø55mm, Ø65mm, Ø85mm, Ø100mm. It can do triac dim, DALI dim, CCT interchangeable and wattage adjustable.

-
-
-
-
-

Code	Watt	Size(AxBmm)	Lumen(±5%)	N.W/pc(kgs)	Q'ty/CTN
PD338A/B-55-6W	6W	Ø55x1189/Ø55x1213	750lm	0.50/0.48	12PCS
PD338A/B-55-10W	10W	Ø55x1189/Ø55x1213	1200lm	0.50/0.48	12PCS
PD338A/B-65-10W	10W	Ø65x1209/Ø65x1233	1200lm	0.61/0.59	12PCS
PD338A/B-65-15W	15W	Ø65x1209/Ø65x1233	1750lm	0.61/0.59	12PCS
PD338A/B-85-20W	20W	Ø85x1235/Ø85x1259	2650lm	0.98/0.87	12PCS
PD338A/B-85-25W	25W	Ø85x1235/Ø85x1259	3200lm	0.98/0.87	12PCS
PD338A/B-100-30W	30W	Ø100x1249/Ø100x1273	3650lm	1.16/1.14	12PCS
PD338A/B-100-35W	35W	Ø100x1249/Ø100x1273	4250lm	1.16/1.14	12PCS

CCT — 2700K 3000K 4000K 5000K

Finish — White Black

TL338 Track light

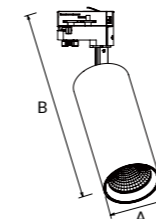

TL338 is a DIY modular series with an exquisite appearance and anti-glare UGR19 design, 6 kinds of installation ways, 3 reflectors and 3 front ring colors can be exchangeable. It adopts brand Bridgelux COB led chip with 120lm/W light efficiency, AL6063 Aluminum profile provides excellent thermal dissipation. Four size options : Ø55mm, Ø65mm, Ø85mm, Ø100mm. It can do triac dim, DALI dim, CCT interchangeable and wattage adjustable.

-
-
-
-
-

Code	Watt	Size(AxBmm)	Lumen(±5%)	N.W/pc(kgs)	Q'ty/CTN
TL338-55-6W	6W	Ø55x233	750lm	0.48	12PCS
TL338-55-10W	10W	Ø55x233	1200lm	0.48	12PCS
TL338-65-10W	10W	Ø65x253	1200lm	0.58	12PCS
TL338-65-15W	15W	Ø65x253	1750lm	0.58	12PCS
TL338-85-20W	20W	Ø85x292	2650lm	0.87	12PCS
TL338-85-25W	25W	Ø85x292	3200lm	0.87	12PCS
TL338-100-30W	30W	Ø100x306	3650lm	1.13	12PCS
TL338-100-35W	35W	Ø100x306	4250lm	1.13	12PCS

CCT — 2700K 3000K 4000K 5000K

Finish — White Black

338D Series



Track spot surface
DL338D-55R-18W



Track spot surface
DL338D-55R-6W



Track spot surface
DL338D-55S-18W



Recessed
DL338D-3-6W



Track light
TL338D-55-6W



Track spot surface
DL338D-55S-12W



DL338D NEW Downlight

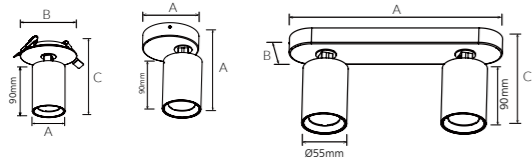

This is a group design with 55mm diameter exquisite lamp body and multiple installation ways. It adopts high lumen COB light source with single CCT or adjustable CCT version, the special optical reflector design provides uniform light output and low glare effect. For installation, it has single/double/triple lamp heads with round or square surface mounting kit options, also support recessed/track installations, which offers more possibilities for different application areas. For structure, AL6063 aluminium body ensure a great thermal management, reflector front ring could be changed easily with white/black/gold color options.

- ▶ 24° 36° 60° 90° IP20
- ▶ DIM Flicker Free SLIDE SWITCH 3 in 1
- ▶ AC 220-240V PF≥0.7 PF≥0.85 CRI≥80 CRI≥90
- ▶ SAA RoHS CE

Code	Watt	Size(AxBxCmm)	Cut-out(mm)	Lumen(±5%)	N.W/pc(kgs)	Q'ty/CTN
DL338D-2.5-6W	6W	55x122x147	Ø68-83	700lm	0.33	24PCS
DL338D-3-6W	6W	55x143x147	Ø90-95	700lm	0.33	24PCS
DL338D-55R-6W	6W	Ø85x139	-	700lm	0.34	24PCS
DL338D-55R-18W	18W	Ø240x139	-	2100lm	1.15	12PCS
DL338D-55S-12W	12W	260x56x139	-	1400lm	0.77	12PCS
DL338D-55S-18W	18W	430x56x139	-	2100lm	1.23	12PCS

CCT 2700K 3000K 4000K 5000K

Trim White Black

Interchangeable lens options Reflector-White Reflector-Black Reflector-Golden



TL338D NEW Track light

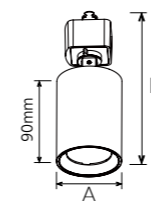

This is a group design with 55mm diameter exquisite lamp body and multiple installation ways. It adopts high lumen COB light source with single CCT or adjustable CCT version, the special optical reflector design provides uniform light output and low glare effect. For installation, it has single/double/triple lamp heads with round or square surface mounting kit options, also support recessed/track installations, which offers more possibilities for different application areas. For structure, AL6063 aluminium body ensure a great thermal management, reflector front ring could be changed easily with white/black/gold color options.

- ▶ 24° 36° 60° 90° IP20
- ▶ DIM Flicker Free SLIDE SWITCH 3 in 1
- ▶ AC 220-240V PF≥0.7 PF≥0.85 CRI≥80 CRI≥90
- ▶ SAA RoHS CE

Code	Watt	Size(AxBxCmm)	Lumen(±5%)	N.W/pc(kgs)	Q'ty/CTN
TL338D-55-6W	6W	Ø55x162	700lm	0.25	24PCS

CCT 2700K 3000K 4000K 5000K

Trim White Black

Interchangeable lens options Reflector-White Reflector-Black Reflector-Golden

228 Series



Surface mounted
DL228A



Track spot surface
DL228B



TL228
with ceiling box



Suspension
PD228



Track light
TL228



Suspension
PD228B



Suspension
PD228B

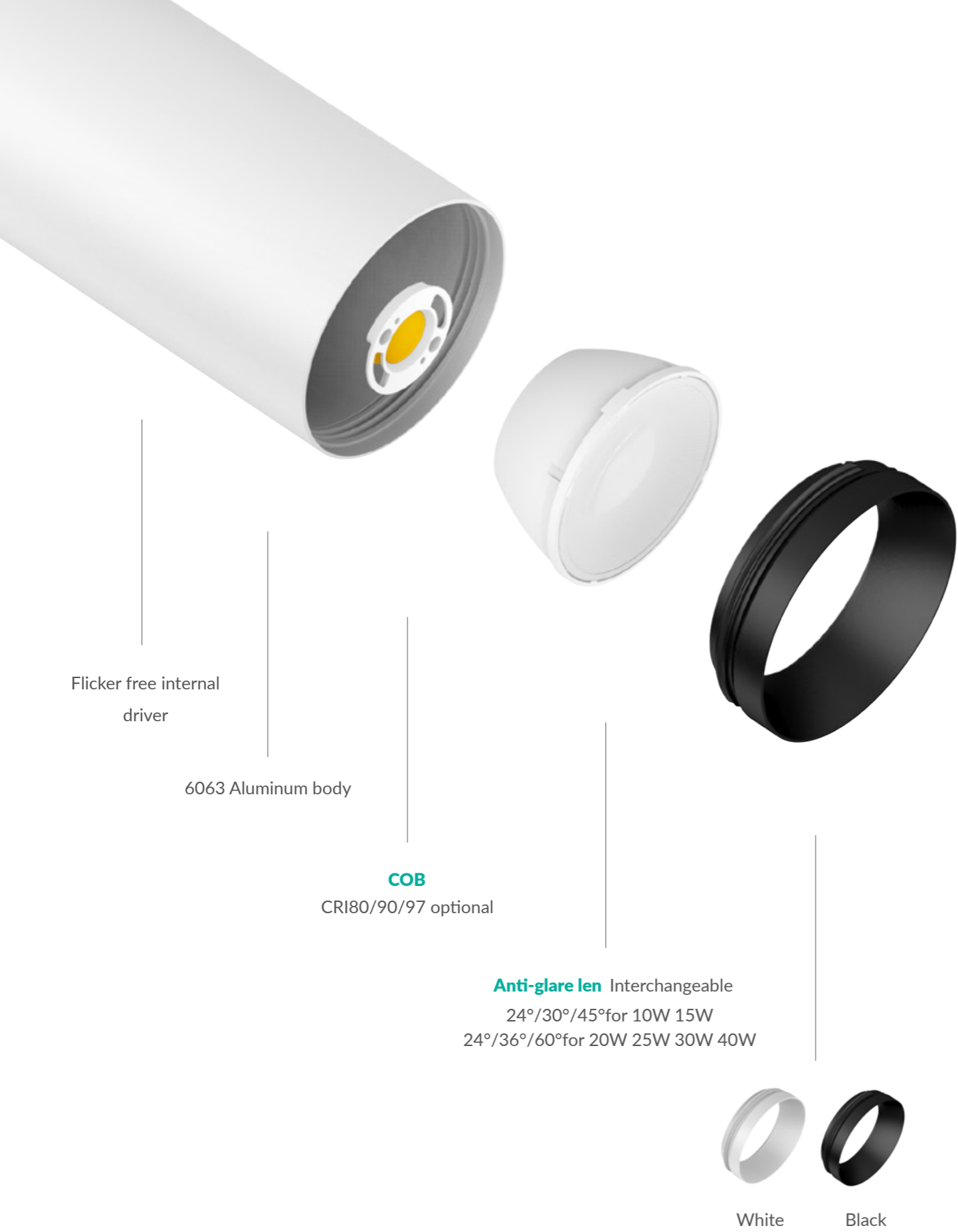



DL228A Downlight

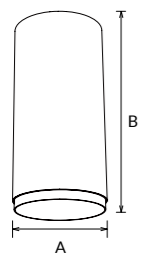

DL228A adopt high lumen COB chip and PMMA lens for uniform light effect and enhanced glare control. Aluminum profile with sufficient heat dissipation guarantee long lifespan. It offers a wide choice of beam angles 24°/30°/36°/45°/60° for optional.

- ▶ 24° 36° 60° IP20
- ▶ DIM Flicker Free
- ▶ AC 200-240V PF≥0.9 CRI≥80 CRI≥90 CRI≥97
- ▶ SAA RoHS CE CB

Code	Watt	Size(AxBmm)	Lumen(±5%)	N.W/pc(kgs)	Q'ty/CTN
DL228A-10W	10W	Ø65x157	1100lm	0.45	12PCS
DL228A-15W	15W	Ø65x157 (Non-dim) Ø85x178 (Triac-dim)	1300lm	0.45	12PCS
DL228A-20W	20W	Ø85x178	2250lm	0.67	12PCS
DL228A-25W	25W	Ø85x178	2700lm	0.67	12PCS
DL228A-30W	30W	Ø100x211	3050lm	1.00	12PCS
DL228A-40W	40W	Ø100x211	4200lm	1.00	12PCS

CCT — 2700K 3000K 4000K 5000K Finish — White Black

Interchangeable lens options — 24°/30°/45° for 10W/15W 24°/36°/60° for 15W/20W/25W/30W/40W



DL228B Downlight

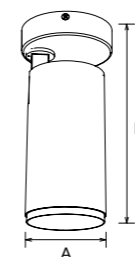

DL228B surface mounted downlight with adjustable lighting orientation, 350° rotate and 90° tilt, It offers a wide choice of beam angles 24°/30°/36°/45°/60° for optional. Aluminum profile with sufficient heat dissipation guarantee long lifespan. Driver built-in, easy for installation.

- ▶ 24° 36° 60° 350°
- ▶ 90° IP20
- ▶ DIM DALI Flicker Free SLIDE SWITCH
- ▶ AC 200-240V PF≥0.9 CRI≥80 CRI≥90 CRI≥97
- ▶ SAA RoHS CE CB

Code	Watt	Size(AxBmm)	Lumen(±5%)	N.W/pc(kgs)	Q'ty/CTN
DL228B-10W	10W	Ø65x218	1100lm	0.55	12PCS
DL228B-15W	15W	Ø65x218 (Non-dim) Ø85x241(Triac-dim)	1300lm	0.55	12PCS
DL228B-20W	20W	Ø85x241	2250lm	0.82	12PCS
DL228B-25W	25W	Ø85x241	2700lm	0.82	12PCS
DL228B-30W	30W	Ø100x274	3050lm	1.15	12PCS
DL228B-40W	40W	Ø100x274	4200lm	1.15	12PCS

CCT — 2700K 3000K 4000K 5000K Finish — White Black

Interchangeable lens options — 24°/30°/45° for 10W/15W 24°/36°/60° for 15W/20W/25W/30W/40W



PD228 Downlight

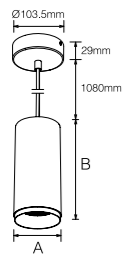

PD228 pendant spot light is a high-performance LED luminaire that is ideal for commercial or residential applications. It adopts high lumen COB chip and PMMA lens for uniform light effect and enhanced glare control. AL6063 Aluminum profile with sufficient heat dissipation guarantee long lifespan.

- ▶ 24° 36° 60°
- ▶ IP20
- ▶ DIM
- ▶ DALI
- ▶ Flicker Free
- ▶ SLIDE SWITCH 3 in 1
- ▶ AC 200-240V
- ▶ PF ≥ 0.9
- ▶ CRI ≥ 80
- ▶ CRI ≥ 90
- ▶ CRI ≥ 97
- ▶ SAA
- ▶ RoHS
- ▶ CE
- ▶ CB

Code	Watt	Size(AxBmm)	Lumen(±5%)	N.W/pc(kgs)	Q'ty/CTN
PD228-10W	10W	Ø65x157	1100lm	0.55	12PCS
PD228-15W	15W	Ø65x157 (Non-dim) Ø85x178 (Triac-dim)	1300lm	0.55	12PCS
PD228-20W	20W	Ø85x178	2250lm	0.80	12PCS
PD228-25W	25W	Ø85x178	2700lm	0.80	12PCS
PD228-30W	30W	Ø100x211	3050lm	1.15	12PCS
PD228-40W	40W	Ø100x211	4200lm	1.15	12PCS

CCT ——— 2700K 3000K 4000K 5000K Finish ——— White Black

Interchangeable lens options ——— 24°/30°/45° for 10W/15W 24°/36°/60° for 15W/20W/25W/30W/40W



TL228 Track light

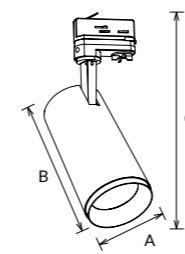

TL228 anti-glare track light is with high lumen COB chip and PMMA lens offer an uniform lighting output, flicker free internal driver and AL6063 aluminium lamp body to ensure excellent heat dissipation. Modular lens design for different beam angle and convenient maintenance.

- ▶ 24° 36° 60° 350°
- ▶ IP20
- ▶ DIM
- ▶ DALI
- ▶ Flicker Free
- ▶ SLIDE SWITCH 3 in 1
- ▶ Bluetooth
- ▶ Smart Lighting
- ▶ CASAMBI
- ▶ AC 200-240V
- ▶ PF ≥ 0.9
- ▶ CRI ≥ 80
- ▶ CRI ≥ 90
- ▶ CRI ≥ 97
- ▶ SAA
- ▶ RoHS
- ▶ CE
- ▶ CB

Code	Watt	Size(AxBxCmm)	Lumen(±5%)	N.W/pc(kgs)	Q'ty/CTN
TL228-10W	10W	Ø65x157x249	1100lm	0.50	12PCS
TL228-15W	15W	Ø65x157x249(Non-dim) Ø85x178x269 (Triac-dim)	1500lm	0.50	12PCS
TL228-20W	20W	Ø85x178x269	2250lm	0.76	12PCS
TL228-25W	25W	Ø85x178x269	2700lm	0.76	12PCS
TL228-30W	30W	Ø100x211x302	3050lm	1.10	12PCS
TL228-40W	40W	Ø100x211x302	4200lm	1.10	12PCS

CCT ——— 2700K 3000K 4000K 5000K Finish ——— White Black Silver

Interchangeable lens options ——— 24°/30°/45° for 10W/15W 24°/36°/60° for 15W/20W/25W/30W/40W

DL284 series



DL284A COB
Lens+Tempered Glass

DL284B COB
Lens+Tempered Glass

DL284C COB
Lens+PC Cover

DL284A SMD
PC Cover+Tempered Glass

DL284B SMD
PC Cover+Tempered Glass

DL284C SMD
PC Cover+PC Cover

IP65 WATERPROOF

COB - Faceted
Beam Angle: 24° / 36° / 60°

DL284A: Tempered glass **IK06**(2.5"/3")
IK08 4"/6"/8"

DL284B: Extend frame
Tempered glass **IK08**

DL284C: Special anti-theft screws
PC cover **IK10**

SMD -Specular
Beam Angle: 75°(3 ") 90°(4"/6"/8 ")

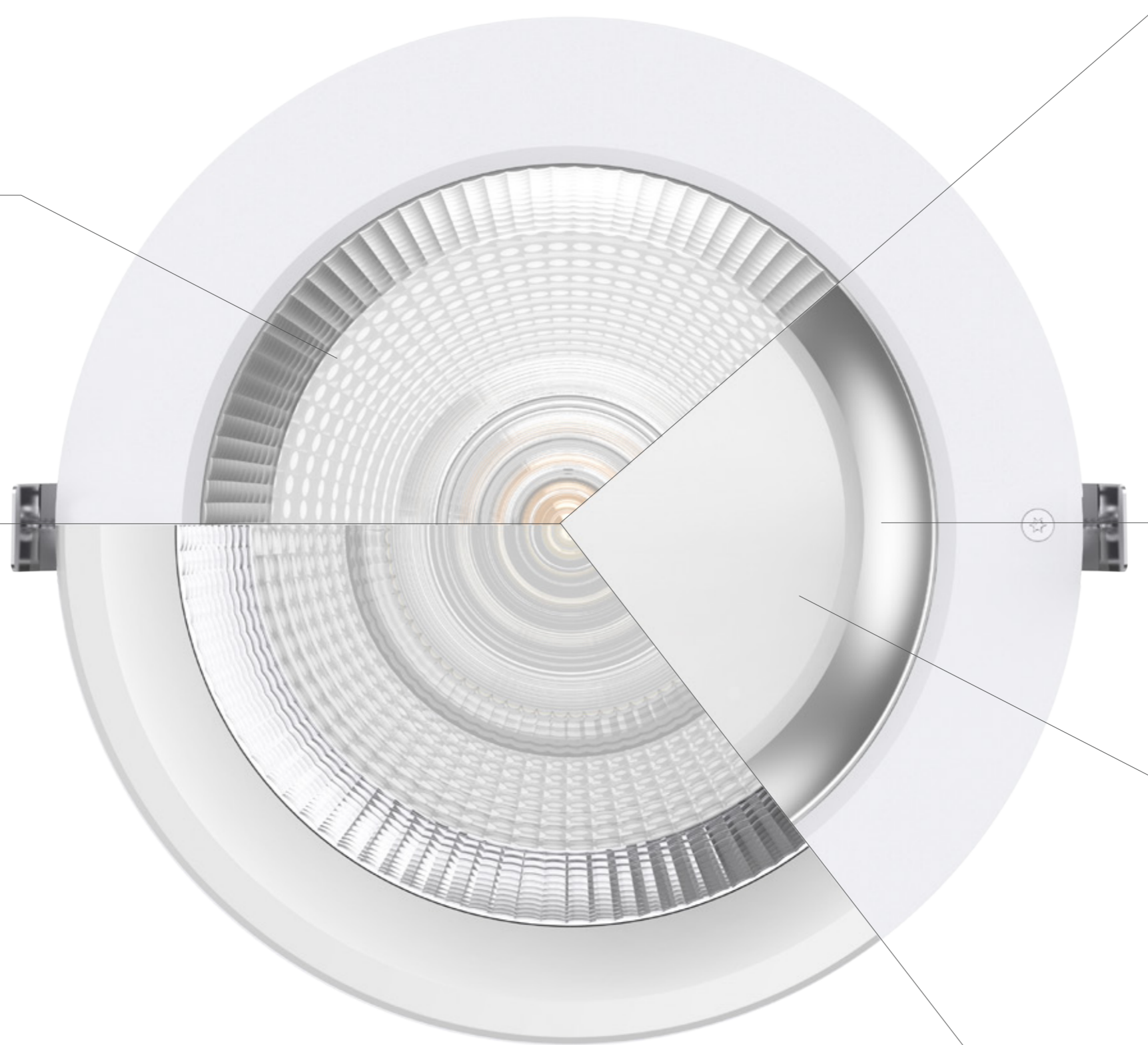



DL284A

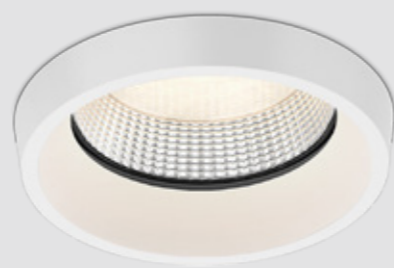

DL284B



DL284A/B

Downlight COB

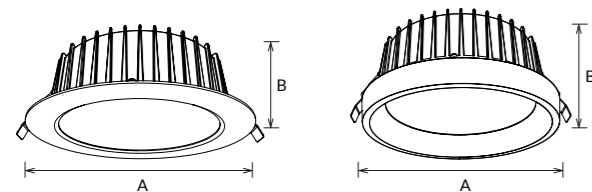

DL284A COB series downlight with traditional deep Faceted reflector which provides a perfect combination of high lighting efficiency, comfortable lighting and low glare design, without compromising on lighting performance (color rendering and color uniformity). ADC12 aluminum housing provides a great thermal management, IP65 waterproof with high protection level, which offers a wider application area. It is with tempered glass as IK06/IK08. Based on DL284A, DL284B added the extend frame which looks like a slim surface mounted downlight.

- ▶
- ▶
- ▶
- ▶
- ▶

Code	Watt	Size(AxBmm)	Cut-out(mm)	Lumen(±5%)	N.W/pc(kgs)	Q'ty/CTN
DL284A-3-10W	10W	Ø110x51	Ø90-Ø95	1050lm	0.34	30PCS
DL284A-3-13W	13W	Ø110x51	Ø90-Ø95	1350lm	0.34	30PCS
DL284A/B-4-18W	18W	Ø150x64/ Ø145x82	Ø125-140/ Ø125-135	1950lm	0.62/0.72	12PCS
DL284A/B-4-25W	25W	Ø150x64/ Ø145x82	Ø125-140/ Ø125-135	2750lm	0.62/0.72	12PCS
DL284A/B-6-18W	18W	Ø172x69/ Ø172x92	Ø150-165/ Ø150-160	1950lm	0.79/0.90	12PCS
DL284A/B-6-25W	25W	Ø172x69/ Ø172x92	Ø150-165/ Ø150-160	2750lm	0.79/0.90	12PCS
DL284A/B-6-30W	30W	Ø172x69/ Ø172x92	Ø150-165/ Ø150-160	3500lm	0.79/0.90	12PCS
DL284A/B-8-18W	18W	Ø235x81/ Ø220x104	Ø200-220/ Ø200-210	1950lm	1.27/1.45	6PCS
DL284A/B-8-25W	25W	Ø235x81/ Ø220x104	Ø200-220/ Ø200-210	2750lm	1.27/1.45	6PCS
DL284A/B-8-35W	35W	Ø235x81/ Ø220x104	Ø200-220/ Ø200-210	3850lm	1.27/1.45	6PCS

CCT — 2700K 3000K 4000K 5000K

Trim — White Black

DL284C

Downlight COB

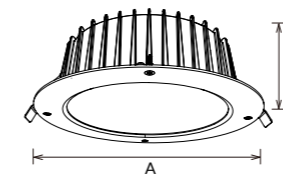

DL284C COB series downlight with traditional deep Faceted reflector which provides a perfect combination of high lighting efficiency, comfortable lighting and low glare design, without compromising on lighting performance (color rendering and color uniformity). ADC12 aluminum housing provides a great thermal management, IP65 waterproof with high protection level, which offers a wider application area. It is with high transmittance PC, the lamp cover is fixed with special anti-theft screws, so that the lamp can be used in special places. The strong structure design makes IP65 and IK10 high protection level.

- ▶
- ▶
- ▶
- ▶
- ▶

Code	Watt	Size(AxBmm)	Cut-out(mm)	Lumen(±5%)	N.W/pc(kgs)	Q'ty/CTN
DL284C-3-10W	10W	Ø110x51	Ø90-Ø95	1050lm	0.34	30PCS
DL284C-3-13W	13W	Ø110x51	Ø90-Ø95	1350lm	0.34	30PCS
DL284C-4-18W	18W	Ø150x64	Ø125-140	1950lm	0.62	12PCS
DL284C-4-25W	25W	Ø150x64	Ø125-140	2750lm	0.62	12PCS
DL284C-6-18W	18W	Ø172x69	Ø150-165	1950lm	0.79	12PCS
DL284C-6-25W	25W	Ø172x69	Ø150-165	2750lm	0.79	12PCS
DL284C-6-30W	30W	Ø172x69	Ø150-165	3500lm	0.79	12PCS
DL284C-8-18W	18W	Ø235x81	Ø200-220	1950lm	1.27	6PCS
DL284C-8-25W	25W	Ø235x81	Ø200-220	2750lm	1.27	6PCS
DL284C-8-35W	35W	Ø235x81	Ø200-220	3850lm	1.27	6PCS

CCT — 2700K 3000K 4000K 5000K

Trim — White Black



DL284A

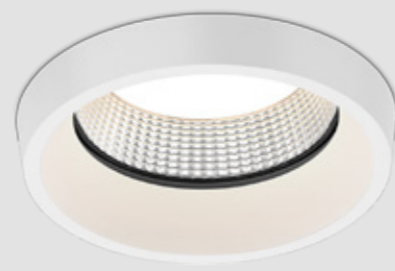

DL284B



DL284A/B

Downlight SMD

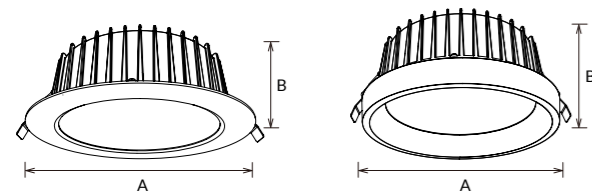

DL284A SMD series downlight with traditional deep Specular reflector which provides a perfect combination of high lighting efficiency, comfortable lighting and low glare design, without compromising on lighting performance (color rendering and color uniformity). ADC12 aluminum housing provides a great thermal management, IP65 waterproof with high protection level, which offers a wider application area. CCT changeable available. It is with tempered glass as IK06/IK08. Based on DL284A, DL284B added the extend frame which looks like a slim surface mounted downlight.

- ▶
- ▶
- ▶
- ▶

Code	Watt	Size(AxBmm)	Cut-out(mm)	Lumen(±5%)	N.W/pc(kgs)	Q'ty/CTN
DL284A-3-10W	10W	Ø110x51	Ø90-Ø95	950lm	0.34	30PCS
DL284A-3-13W	13W	Ø110x51	Ø90-Ø95	1300lm	0.34	30PCS
DL284A/B-4-18W	18W	Ø150x64/ Ø145x82	Ø125-140/ Ø125-135	1950lm	0.62/0.72	12PCS
DL284A/B-4-25W	25W	Ø150x64/ Ø145x82	Ø125-140/ Ø125-135	2750lm	0.62/0.72	12PCS
DL284A/B-6-18W	18W	Ø172x69/ Ø172x92	Ø150-165/ Ø150-160	1950lm	0.79/0.90	12PCS
DL284A/B-6-25W	25W	Ø172x69/ Ø172x92	Ø150-165/ Ø150-160	2750lm	0.79/0.90	12PCS
DL284A/B-6-30W	30W	Ø172x69/ Ø172x92	Ø150-165/ Ø150-160	3500lm	0.79/0.90	12PCS
DL284A/B-8-18W	18W	Ø235x81/ Ø220x104	Ø200-220/ Ø200-210	1950lm	1.27/1.45	6PCS
DL284A/B-8-25W	25W	Ø235x81/ Ø220x104	Ø200-220/ Ø200-210	2750lm	1.27/1.45	6PCS
DL284A/B-8-35W	35W	Ø235x81/ Ø220x104	Ø200-220/ Ø200-210	3850lm	1.27/1.45	6PCS

CCT — 3000K 4000K 5000K 5700K

Trim — White Black

DL284C

Downlight SMD

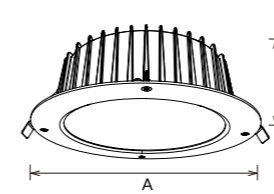

DL284C SMD series downlight with traditional deep Specular reflector which provides a perfect combination of high lighting efficiency, comfortable lighting and low glare design, without compromising on lighting performance (color rendering and color uniformity). ADC12 aluminum housing provides a great thermal management, IP65 waterproof with high protection level, which offers a wider application area. CCT changeable available. It is with high transmittance PC, the lamp cover is fixed with special anti-theft screws, so that the lamp can be used in special places. The strong structure design makes IP65 and IK10 high protection level.

- ▶
- ▶
- ▶
- ▶

Code	Watt	Size(AxBmm)	Cut-out(mm)	Lumen(±5%)	N.W/pc(kgs)	Q'ty/CTN
DL284C-3-10W	10W	Ø110x51	Ø90-Ø95	1050lm	0.34	30PCS
DL284C-3-13W	13W	Ø110x51	Ø90-Ø95	1350lm	0.34	30PCS
DL284C-4-18W	18W	Ø150x64	Ø125-140	1950lm	0.62	12PCS
DL284C-4-25W	25W	Ø150x64	Ø125-140	2750lm	0.62	12PCS
DL284C-6-18W	18W	Ø172x69	Ø150-165	1950lm	0.79	12PCS
DL284C-6-25W	25W	Ø172x69	Ø150-165	2750lm	0.79	12PCS
DL284C-6-30W	30W	Ø172x69	Ø150-165	3500lm	0.79	12PCS
DL284C-8-18W	18W	Ø235x81	Ø200-220	1950lm	1.27	6PCS
DL284C-8-25W	25W	Ø235x81	Ø200-220	2750lm	1.27	6PCS
DL284C-8-35W	35W	Ø235x81	Ø200-220	3850lm	1.27	6PCS

CCT — 3000K 4000K 5000K 5700K

Trim — White Black

332 series

TYPE A
Symmetric beam

TYPE B
Asymmetric beam

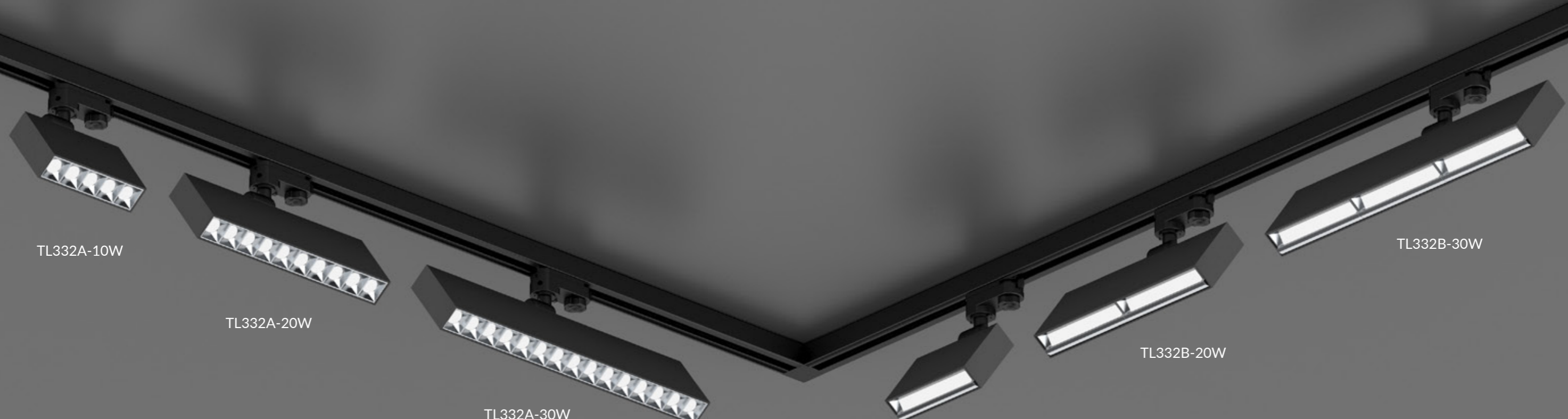

TL332A-10W

TL332A-20W

TL332A-30W

TL332B-10W

TL332B-20W

TL332B-30W

Surface mounted type



DL332A-10W

DL332A-20W

DL332A-30W

DL332B-30W

DL332B-20W

DL332B-10W

SPECIAL BEAM DESIGN

TYPE A
Symmetric Beam
15°/30°

TYPE B
Symmetric Beam
70°x90°x15°



Optics display

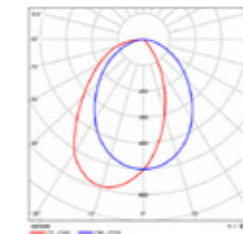
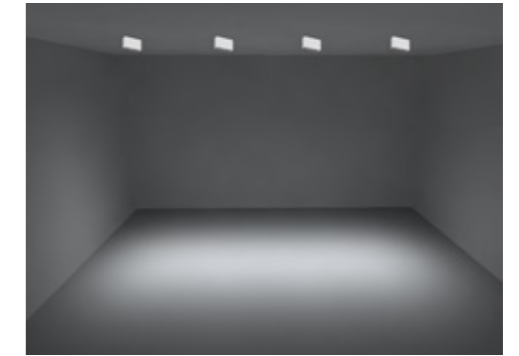
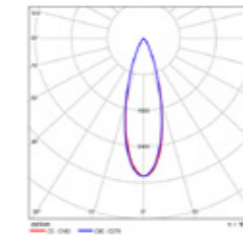
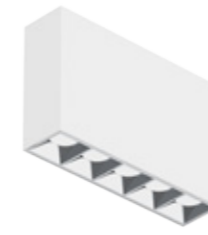

DIY Design

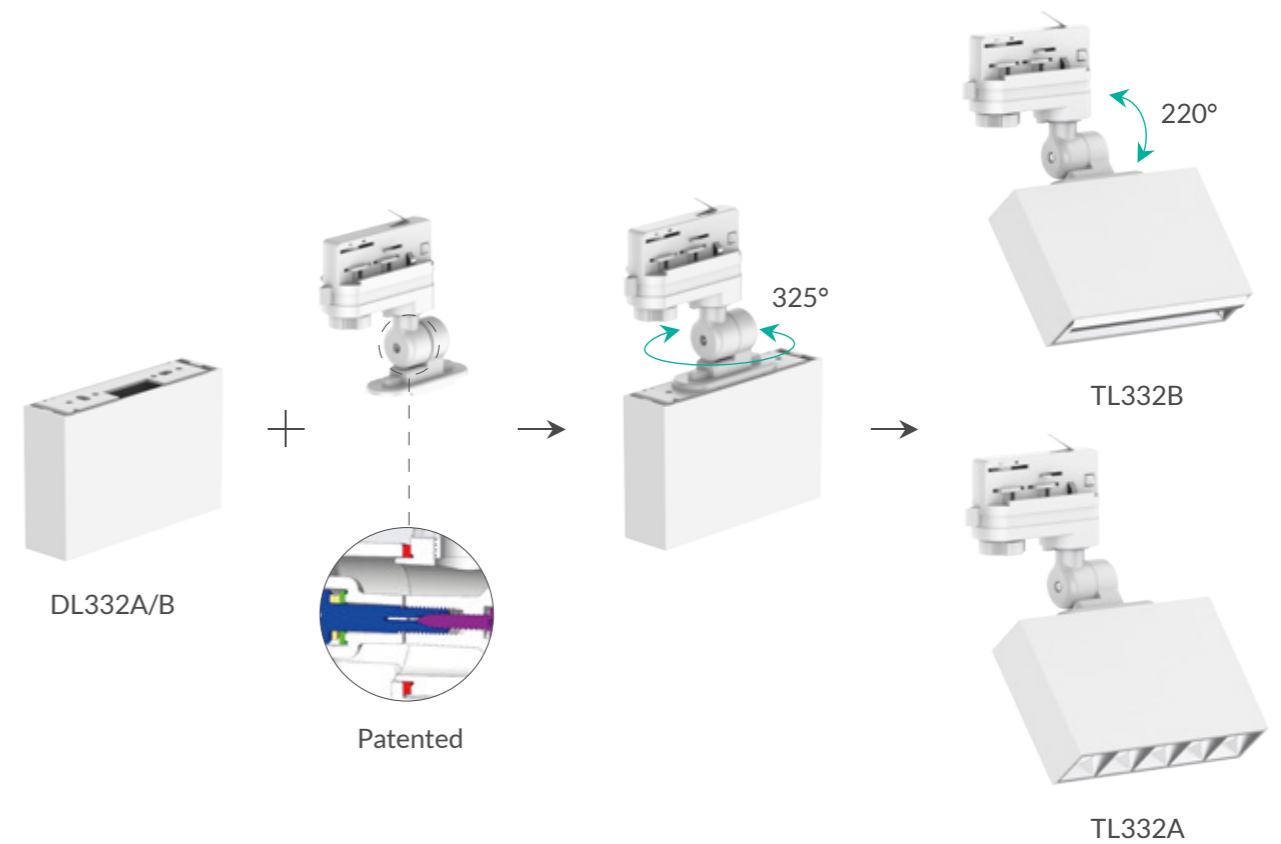

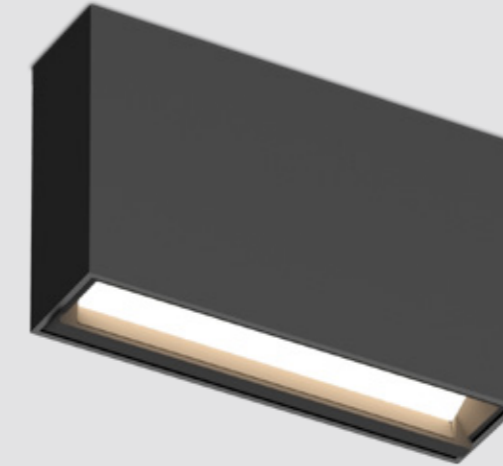
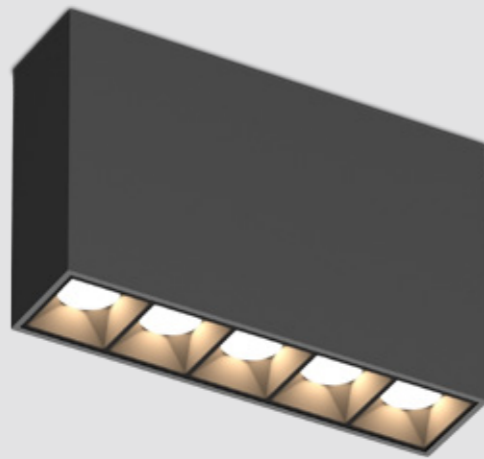

DL332A Downlight

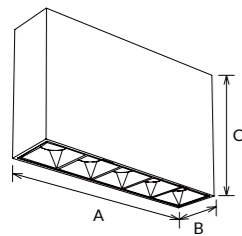

DL332A surface mounted downlight is with symmetric beam design. The aluminum die-casting frame with UV-proof white powder coating finishing provides an excellent thermal management. It adopts SMD light source, high lumen and high CRI offers a uniform light output. It can offer a comfortable visual experience with low glare UGR<16.

- ▶ 15° 30°
- ▶ IP20
- ▶ UGR<16

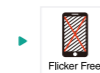

- ▶ AC 220-240V
- ▶ PF≥0.9
- ▶ CRI≥90

- ▶ SAA RoHS CE

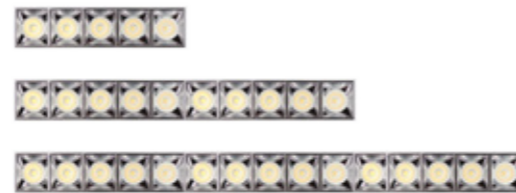

Code	Watt	Size(AxBxCmm)	Lumen(±5%)	N.W/pc(kgs)	Q'ty/CTN
DL332A-10W	10W	138x35x91	1080lm	0.48	12PCS
DL332A-20W	20W	271x35x91	2200lm	0.48	12PCS
DL332A-30W	30W	404x35x91	3200lm	0.79	12PCS

CCT 2700K 3000K 4000K

Trim White Black

DL332B Downlight

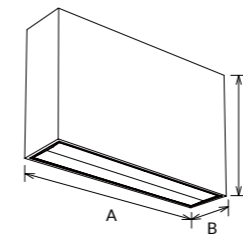

DL332B surface mounted downlight is with asymmetric beam design. The aluminum die-casting frame with UV-proof white powder coating finishing provides an excellent thermal management. It adopts SMD light source, high lumen and high CRI offers a uniform light output. It could offer a special light spot, users will have a great visual enjoyment.

- ▶ 70°x90°x15°
- ▶ IP20

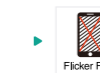

- ▶ AC 220-240V
- ▶ PF≥0.9
- ▶ CRI≥90

- ▶ SAA RoHS CE



Code	Watt	Size(AxBxCmm)	Lumen(±5%)	N.W/pc(kgs)	Q'ty/CTN
DL332B-10W	10W	138x35x91	750lm	0.79	12PCS
DL332B-20W	20W	271x35x91	1350lm	1.16	6PCS
DL332B-30W	30W	404x35x91	2000lm	1.16	6PCS

CCT 2700K 3000K 4000K

Trim White Black



TL332A Track light

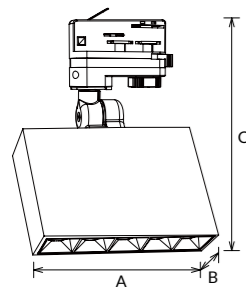

TL332A can be DIY from DL332A, it is with symmetric beam design. The aluminum die-casting frame with UV-proof white powder coating finishing provides an excellent thermal management. It adopts SMD light source, high lumen and high CRI offers a uniform light output. It can offer a comfortable visual experience with low glare UGR<16.

- ▶ 15° 30° 325° 220° IP20
- ▶ UGR<16
- ▶ Flicker Free
- ▶ AC 220-240V PF≥0.9 CRI≥90
- ▶ SAA RoHS CE

Code	Watt	Size(AxBxCmm)	Lumen(±5%)	N.W/pc(kgs)	Q'ty/CTN
TL332A-10W	10W	138x35x196	1080lm	0.63	12PCS
TL332A-20W	20W	271x35x196	2200lm	0.93	12PCS
TL332A-30W	30W	404x35x196	3200lm	1.31	6PCS

TL332B Track light

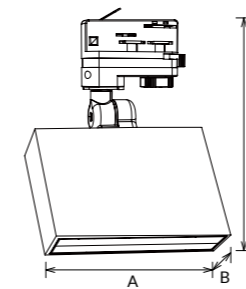

TL332B can be DIY from DL332B, it is with asymmetric beam design. The aluminum die-casting frame with UV-proof white powder coating finishing provides an excellent thermal management. It adopts SMD light source, high lumen and high CRI offers a uniform light output. It could offer a special light spot, users will have a great visual enjoyment.

- ▶ 70°x90°x15° 325° 220° IP20
- ▶ Flicker Free
- ▶ AC 220-240V PF≥0.9 CRI≥90
- ▶ SAA RoHS CE

Code	Watt	Size(AxBxCmm)	Lumen(±5%)	N.W/pc(kgs)	Q'ty/CTN
TL332B-10W	10W	138x35x198	750lm	0.63	12PCS
TL332B-20W	20W	271x35x196	1350lm	0.93	12PCS
TL332B-30W	30W	404x35x198	2000lm	1.31	6PCS

340 series

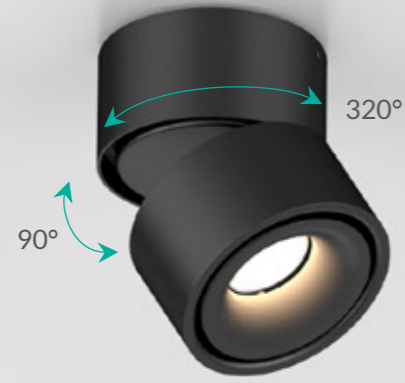

DL340A

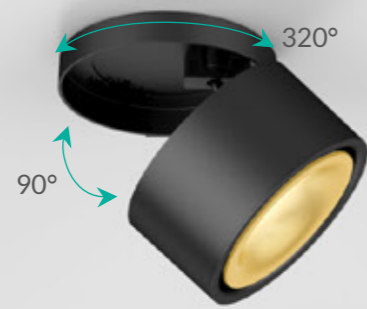

DL340B

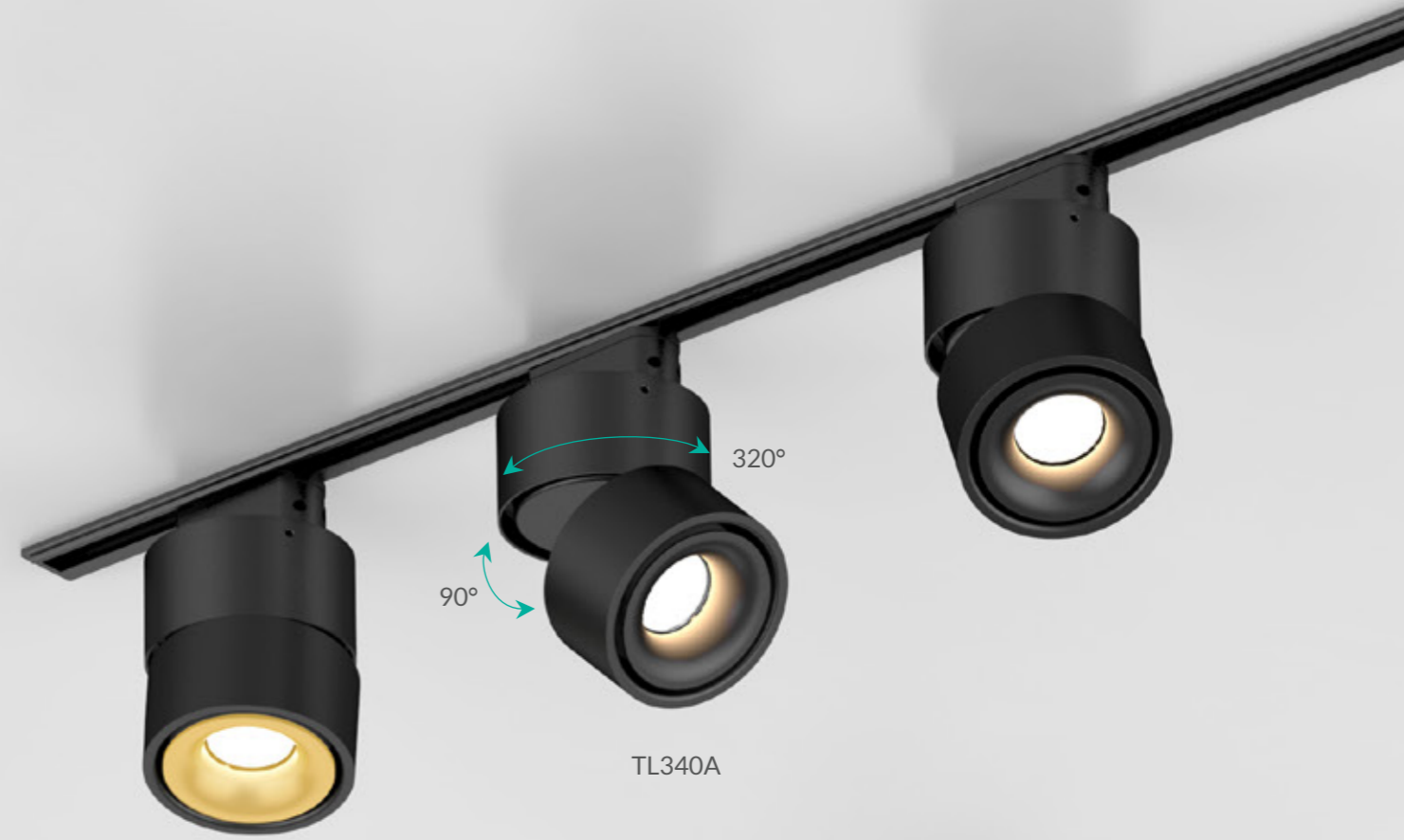

TL340A

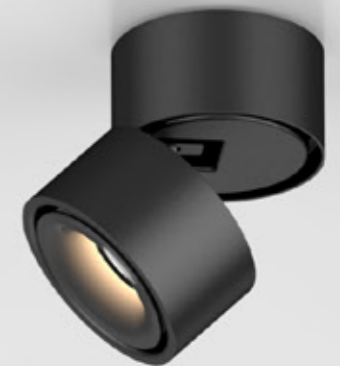



UGR<16



ACC-DL340-BK
Black



ACC-DL340-WT
White



ACC-DL340-GD
Gold

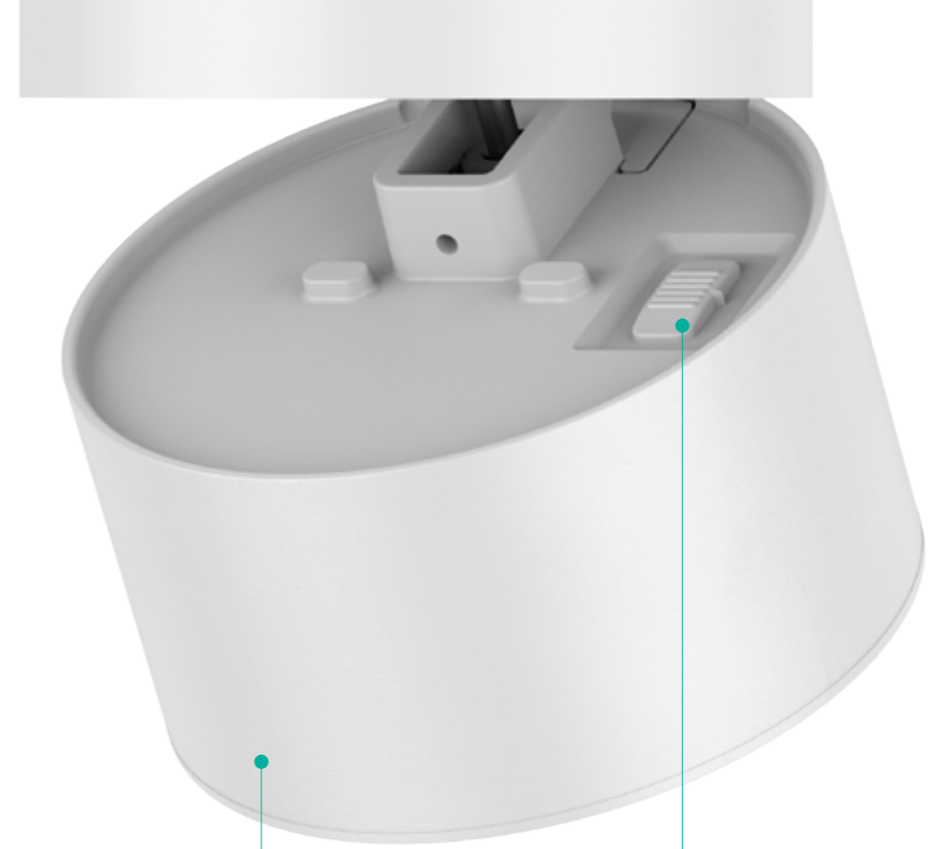

ADC12 Aluminium



CW
NW
WW

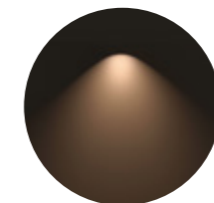

WW

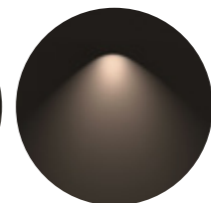

NW



CW



DL340A



DL340B



DL340 Downlight

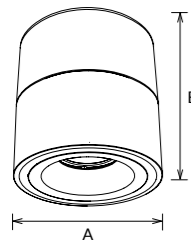

DL340 is LED spot available in 2 installation types , DL340A - surface mounted with head of 90 degree adjustable on vertical and 320 degree on horizontal, DL340B - recessed type with head of 80 degree adjustable on vertical and 320 degree on horizontal. Both adopt high quality COB LED, PC diffuser and PMMA lens for uniform beam. DL340A comes with internal flicker-free non-dim driver only , DL340B can come with external flicker-free non-dim , triac dim or Dali driver. 3CCT changeable for option , IP40 for indoor use only.

- ▶ Beam angle: 20°, 36°, 320°, 90°
- ▶ IP20
- ▶ UGR<16
- ▶ DIM
- ▶ Flicker Free
- ▶ SLIDE SWITCH
- ▶ AC 220-240V
- ▶ PF≥0.9
- ▶ CRI≥80
- ▶ SAA
- ▶ RoHS
- ▶ CE

Code	Watt	Size(AxBmm)	Cut-out(mm)	Lumen(±5%)	N.W/pc(kgs)	Q'ty/CTN
DL340A-10W/C3	10W	Ø100x108	/	1100lm/900lm	0.50	24PCS
DL340A-15W/C3	15W	Ø100x108	/	1550lm/1250lm	0.54	24PCS
DL340B-10W/C3	10W	Ø100x100	Ø85-95	1100lm/900lm	0.44	24PCS
DL340B-10W-D	10W	Ø100x100	Ø85-95	1050lm	0.47	24PCS
DL340B-10W-P3	10W	Ø100x100	Ø85-95	900lm	0.48	24PCS
DL340B-15W/C3	15W	Ø100x100	Ø85-95	1550lm/1250lm	0.44	24PCS
DL340B-15W-D	15W	Ø100x100	Ø85-95	1500lm	0.53	24PCS
DL340B-15W-P3	15W	Ø100x100	Ø85-95	1250lm	0.54	24PCS

CCT — 2700K — 3000K — 4000K — 5000K

Trim — White Black

TL340 Track light



TL340 is LED spot with head of 90 degree adjustable on vertical and 320 degree on horizontal. It adopts high quality COB LED, PC diffuser and PMMA lens for uniform beam. Comes with internal flicker-free non-dim driver only . 3CCT changeable for option , IP40 for indoor use only.

- ▶ Beam angle: 20°, 36°, 320°, 90°
- ▶ IP20
- ▶ UGR<16
- ▶ DIM
- ▶ Flicker Free
- ▶ SLIDE SWITCH
- ▶ AC 220-240V
- ▶ PF≥0.9
- ▶ CRI≥80
- ▶ SAA
- ▶ RoHS
- ▶ CE

Code	Watt	Size(AxBmm)	Lumen(±5%)	N.W/pc(kgs)	Q'ty/CTN
TL340A-10W	10W	Ø100x166	1100lm	0.58	24PCS
TL340A-10W-C3	10W	Ø100x166	900lm	0.59	24PCS
TL340A-15W	15W	Ø100x166	1550lm	0.62	24PCS
TL340A-15W-C3	15W	Ø100x166	1250lm	0.63	24PCS

CCT — 2700K — 3000K — 4000K — 5000K

Trim — White Black

382 Series

DL382A/TL382A (SMD)



TL382B/DL382B
(accessories for GU10)

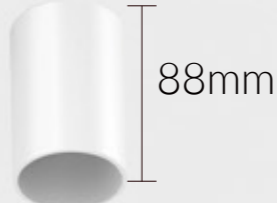

ACC-DL365-88

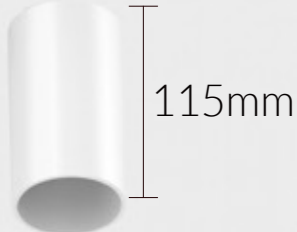

ACC-DL365-115



DL382A NEW Downlight

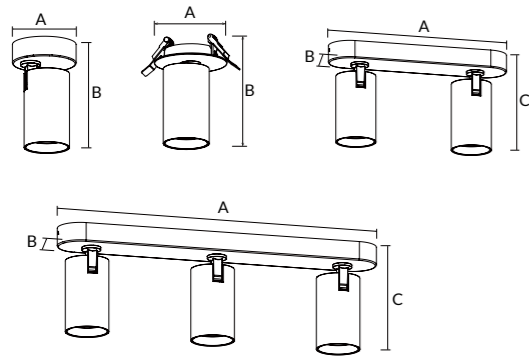

DL382A adopts SMD led chip and reflector as a standard LED light, with AL6063 aluminium housing for good heat dissipation. There are single/double/triple heads for surface mounted and one head version for recessed installation for options. Horizontal 350 degree and vertical 90 degree rotation are available.

- ▶
- ▶
- ▶
- ▶
- ▶

Code	Watt	Size(AxBmm)	Cut-out(mm)	Lumen(±5%)	N.W/pc(kgs)	Q'ty/CTN
DL382A-2.5-8W	8W	Ø95x142	Ø68-83	780lm	0.37	18PCS
DL382A-80-8W	8W	Ø80x134	-	780lm	0.40	30PCS
DL382A-260-16W	2x8W	260x60x134	-	1550lm	0.83	12PCS
DL382A-430-24W	3x8W	430x60x134	-	2350lm	1.29	12PCS

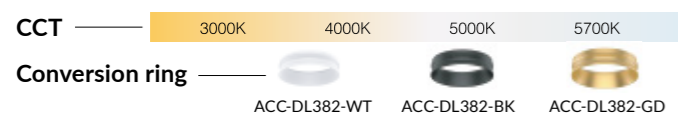

TL382A NEW Track light

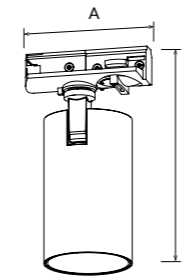

- ▶
- ▶
- ▶
- ▶

TL382A adopts SMD led chip and reflector as a standard LED light, with AL6063 aluminium housing for good heat dissipation. 3 wire 1 circuit track installation is available. Horizontal 350 degree and vertical 90 degree rotation.

Code	Watt	Size(AxBmm)	Lumen(±5%)	N.W/pc(kgs)	Q'ty/CTN
TL382A-8W	8W	Ø80x134	780lm	0.30	30PCS

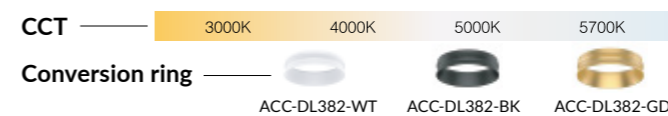

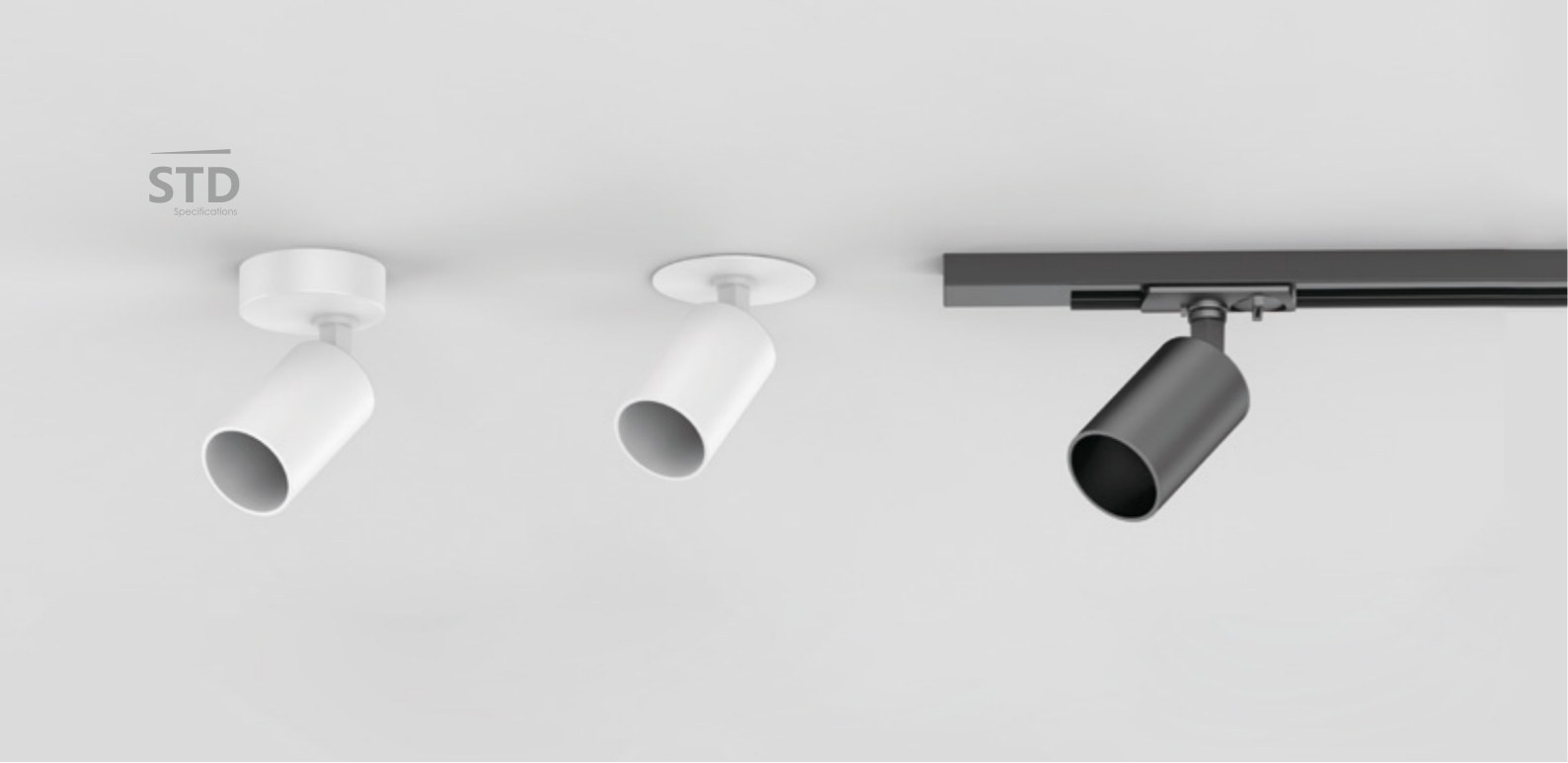

ACC TL382B/DL382B NEW Downlight/Track light

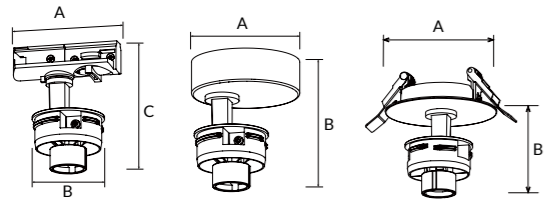

- ▶ 350° / 90°
- ▶ Flicker Free
- ▶ AC 200-240V

ACC TL382B/DL382B is GU10 lamp socket kits, which can support a flexible and quick GU10 module replacement. There are single/double/triple heads for surface mounted, one head version for recessed installation, also has thin track adapter (3 wire 1 circuit) for track installation for options. Horizontal 350 degree and vertical 90 degree rotation are available.

Code	Max Watt	Number Of Lamps	Size(AxBxCmm)	Cut-out(mm)	N.W/pc(kgs)	Q'ty/CTN
ACC-TL382B-3	8W	Max 1	85x54.7x96.6	-	0.09	30PCS
ACC-DL382B-2.5	8W	Max 1	Ø95x103.5	Ø68-83	0.21	18PCS
ACC-DL382B-80	8W	Max 1	Ø80x95	-	0.19	30PCS
ACC-DL382B-260	2x8W	Max 2	260x60x95	-	0.48	12PCS
ACC-DL382B-430	3x8W	Max 3	430x60x95	-	1.29	12PCS
ACC-DL365-88	-	-	Ø57x88	-	0.10	60PCS
ACC-DL365-115	-	-	Ø57x115	-	0.13	60PCS

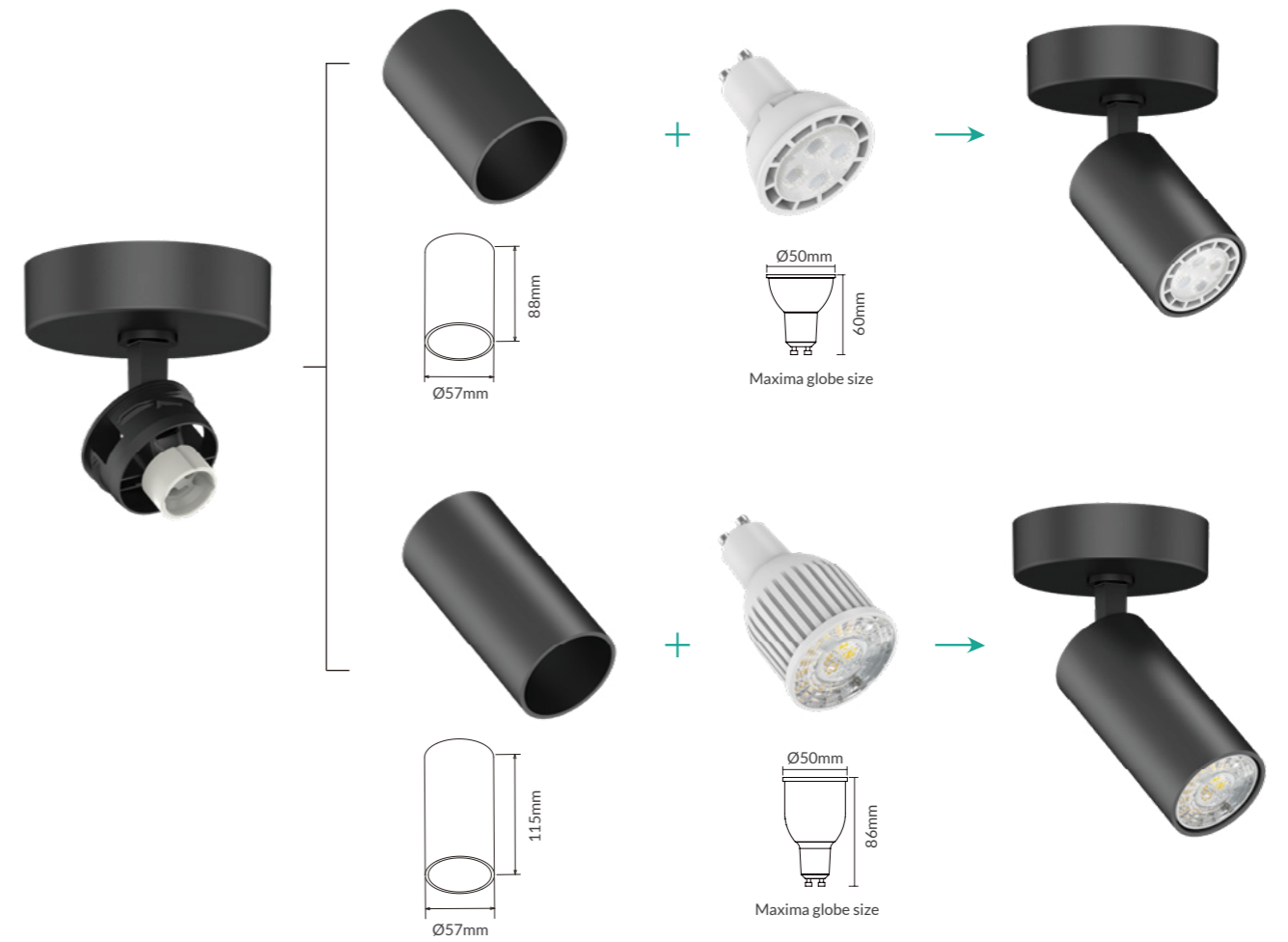
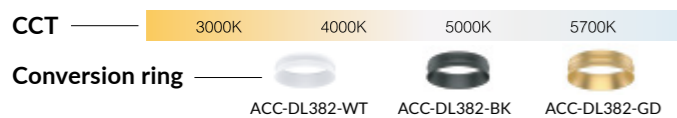

Please note that remove or install light fixtures after power off!

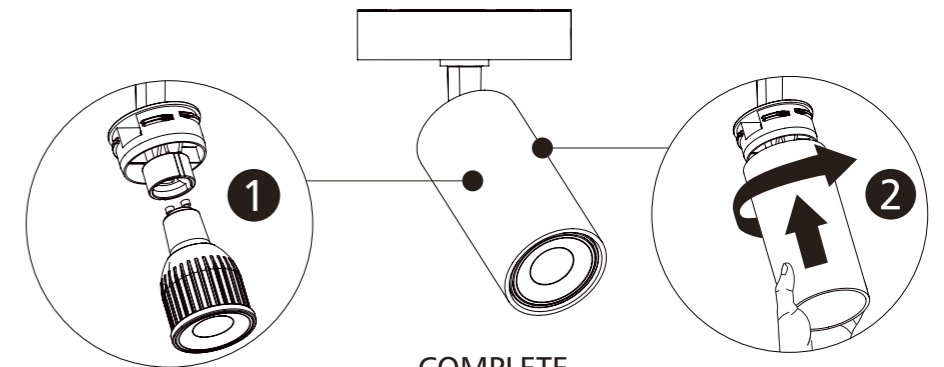

COMPLETE



ACC-TL382B



ACC-DL382B



ACC-DL382B-2.5

365 SERIES

B DL365B

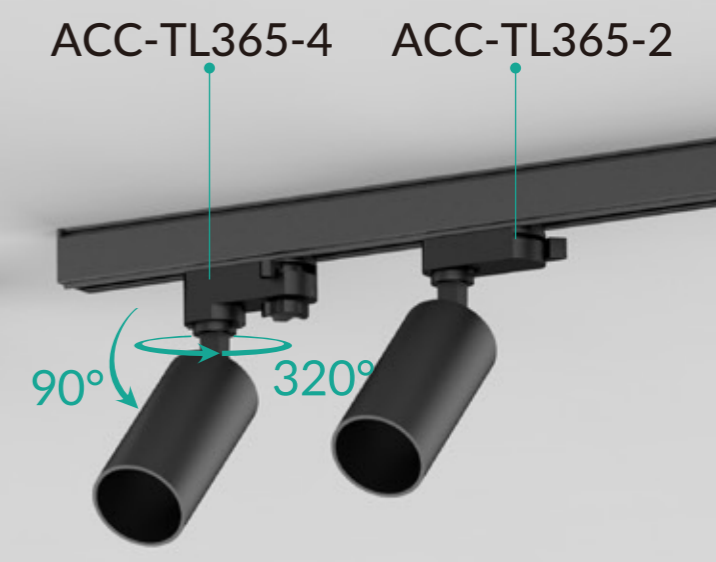
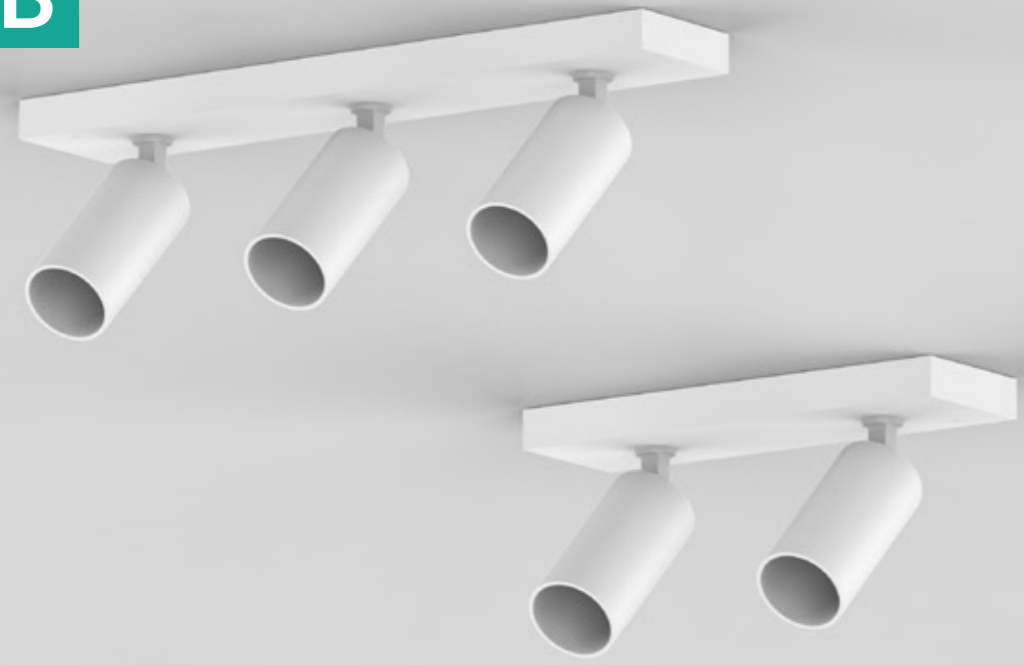

A DL365A

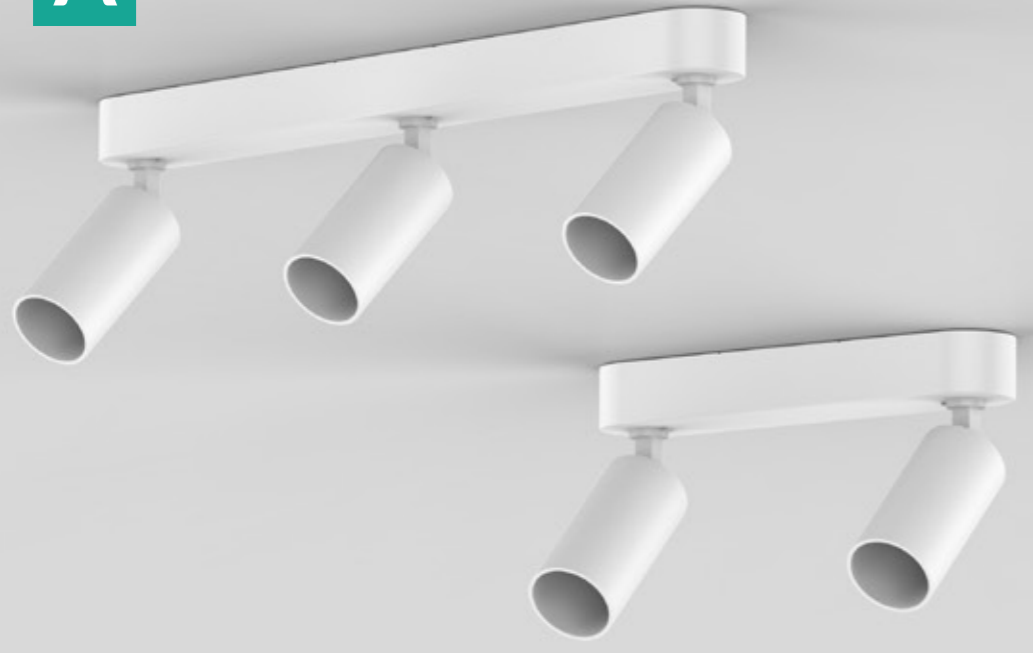



DL365 Downlight

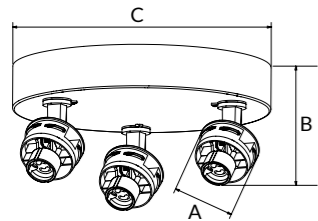

365 series is a design of GU10 lamp socket kits, it can support a flexible GU10 module replacement. Aluminum housing for good thermal management control as textured painting. It can do white or black color.

- ▶ 320° 90°
- ▶ Flicker Free
- ▶ AC 220-240V

Code	Max Watt	Number Of Lamps	Size(AxBxCmm)	N.W/pc(kgs)	Q'ty/CTN
ACC-DL365A-300	2x8W	Max 2	300x62x112.8	0.60	12PCS
ACC-DL365A-560	3x8W	Max 3	560x62x112.8	0.92	12PCS
ACC-DL365A-230	3x8W	Max 3	Ø230x112.8	0.93	12PCS
ACC-DL365B-110	8W	Max 1	110x90x95.8	0.45	24PCS
ACC-DL365B-300	2x8W	Max 2	305x90x95.8	0.79	12PCS
ACC-DL365B-480	3x8W	Max 3	480x90x95.8	1.13	12PCS
ACC-DL365-88	-	-	Ø57x88	0.10	60PCS
ACC-DL365-115	-	-	Ø57x115	0.13	60PCS

CCT — 2700K 3000K 4000K 5000K

Finish — White Black



TL365 Track light

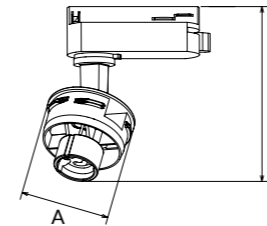

365 series is a design of GU10 lamp socket kits, it can support a flexible GU10 module replacement. Aluminum housing for good thermal management control as textured painting. It can do white or black color.

- ▶ 320° 90°
- ▶ Flicker Free
- ▶ AC 220-240V

Code	Max Watt	Number Of Lamps	Size(AxBxCmm)	N.W/pc(kgs)	Q'ty/CTN
ACC-TL365-2	8W	Max 1	Ø54.7x102.4	0.11	36PCS
ACC-TL365-4	8W	Max 1	Ø54.7x123.3	0.14	12PCS

CCT — 2700K 3000K 4000K 5000K

Finish — White Black

383 Series



Track spot surface
DL383A-70



Recessed
DL383A-2.5-8W



Track light
TL383A-8W

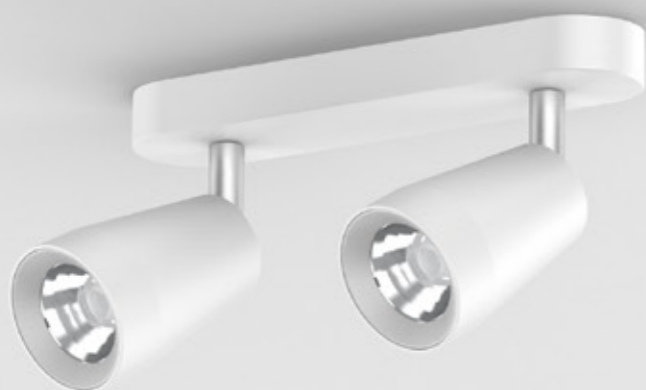

Track spot surface
DL383A-260

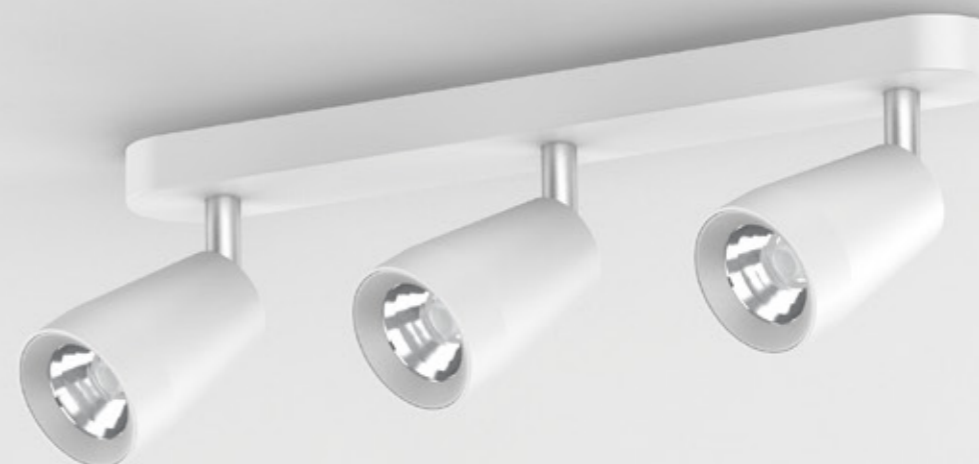

Track spot surface
DL383A-430



DL383 NEW Downlight

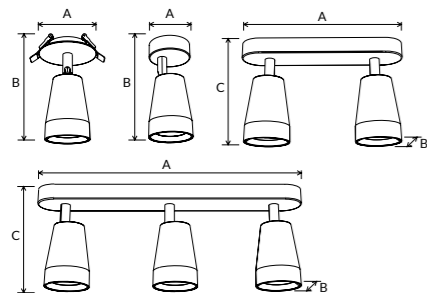

DL383A is a multiple head surface mounted downlight(1/2/3 heads), with the special design of adjusting lighting orientation, 350° horizontally and 90° vertically. ADC12 Aluminum profile provides excellent thermal dissipation. White/ black/gold cover are available. 30° and 45° reflector for options. The lamp housing with a threaded rotating structure design, make it more elegant and unique.

- ▶
- ▶
- ▶
- ▶
- ▶

Code	Watt	Size(AxBxCmm)	Cut-out(mm)	Lumen(±5%)	N.W/pc(kgs)	Q'ty/CTN
DL383A-2.5-8W	8W	Ø95x173	Ø68-83	780lm	0.46	18PCS
DL383A-70-8W	8W	Ø70x165	-	780lm	0.45	18PCS
DL383A-260-16W	2x8W	260x70x165	-	1550lm	0.98	12PCS
DL383A-430-24W	3x8W	430x70x165	-	2350lm	1.50	6PCS

CCT 3000K 4000K 5000K 5700K

Trim White Black

TL383 NEW Track light

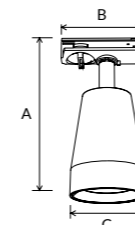

TL383A adopts high lumen SMD LED, ADC12 aluminum lamp body to provides superior heat dissipation, it can be horizontally rotated up to 350 degrees and vertically tilted up to 90 degrees, white/black/gold front rings are interchangeable. DL/TL383B is a series of empty aluminium housing with GU10 lamp socket kits. Surface mounted, recessed and track installation.

- ▶
- ▶
- ▶
- ▶

Code	Watt	Size(AxBxCmm)	Lumen(±5%)	N.W/pc(kgs)	Q'ty/CTN
TL383A-8W	8W	166x85x70	780lm	0.35	18PCS

CCT 3000K 4000K 5000K 5700K

Finish White Black



LED Downlight

/Series/

LED downlight series provide turn-key lighting solutions in domestic and commercial applications. Our downlight is a combination of technique and emotion. We offer our customers a platform to experience the good quality and lighting effects with unique design, 100lm/w and more, UGR<19, Ra80 and Ra90, smart function. ELWA LED downlight family provides different solutions for project and distribution with different product types: COB/SMD version, IP54/IP44/IP20, recessed/surface mounted/pendant, different sizes, different watts. The export volume of ELWA downlight is in the top three for three consecutive years according to China export data. ELWA is your one-stop service supplier for any downlight you're looking for!

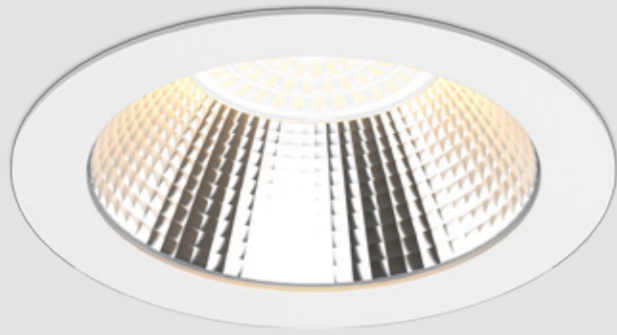

DL367 Downlight

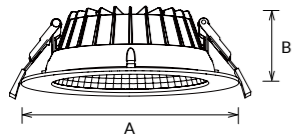

DL367 SMD downlight is with high lumen efficiency 140lm/w as external driver, adopting Aluminum die-casting housing for good heat dissipation. The concave design in front and reflector+lens optic combination reduced the height of the lamp and make it anti-glare. Besides, can do surface mounted with extra accessory for 4/6/8 inches. More function as CCT adjustable, sensor available, one lamp with multiple function use.

-
-
-
-

Code	Watt	Size(AxBmm)	Cut-out(mm)	Lumen(±5%)	N.W/pc(kgs)	Q'ty/CTN
DL367-4-9W	9W	Ø145x55	Ø120-130	1300lm	0.32	24PCS
DL367-4-12W	12W	Ø145x55	Ø120-130	1750lm	0.32	24PCS
DL367-5-11W	11W	Ø170x58	Ø140-150	1600lm	0.39	24PCS
DL367-5-16W	16W	Ø170x58	Ø140-150	2200lm	0.39	24PCS
DL367-6-12W	12W	Ø190x61	Ø160-170	1780lm	0.44	24PCS
DL367-6-18W	18W	Ø190x61	Ø160-170	2550lm	0.44	24PCS
DL367-6-24W	24W	Ø190x61	Ø160-170	3200lm	0.44	24PCS
DL367-8-12W	12W	Ø228x61	Ø200-210	1850lm	0.59	24PCS
DL367-8-18W	18W	Ø228x61	Ø200-210	2650lm	0.59	24PCS
DL367-8-24W	24W	Ø228x61	Ø200-210	3450lm	0.59	24PCS
DL367-6-9W-S1	9W	Ø180x61	Ø160-170	1300lm	0.6	24PCS
DL367-6-12W-S1	12W	Ø180x61	Ø160-170	1750lm	0.6	24PCS

CCT ——— 2700K 3000K 4000K 5000K

Trim ——— White Black

Conversion ring ——— ACC-DL367-4-WT ACC-DL367-6-WT ACC-DL367-8-WT

DL367 SERIES

- UGR<19
- 140lm/W
- SLIDE SWITCH 3 in 1 (COOL WHITE, WARM WHITE, DAYLIGHT)



Adjustable PIR sensor(6")

- SENS: Detection Area
- TIME: Hold Time
- LUX: Daylight Sensor

DIY to Surface Mounting



DL367-4"/6"/8"



DL210 Downlight

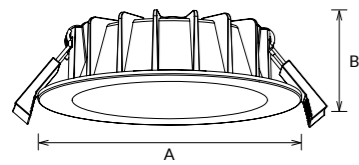

DL210 LED downlight is with super slim design, external driver, adopting high lumen SMD LED, PC diffuser with uniform light. ADC12 Aluminum profile provides excellent thermal dissipation. Interchangeable CCT with slide switch is available. IP54 waterproof for front side.

- ▶ 100° Beam Angle, IP20/IP54
- ▶ DIM, DALI, 0-10V, Flicker Free, SLIDE SWITCH, WIFI
- ▶ Bluetooth, Smart Lighting
- ▶ AC 200-240V, PF≥0.9, CRI≥80
- ▶ SAA, RoHS, CE

Code	Watt	Size(AxBmm)	Cut-out(mm)	Lumen(±5%)	N.W/pc(kgs)	Q'ty/CTN
DL210-3-10W	10W	Ø110x30	Ø90-95	1000lm	0.25	36PCS
DL210-3-13W	13W	Ø110x30	Ø90-95	1320lm	0.25	36PCS
DL210-4-13W	13W	Ø145x30	Ø120-130	1370lm	0.35	30PCS
DL210-4-18W	18W	Ø145x30	Ø120-130	1980lm	0.35	30PCS
DL210-6-18W	18W	Ø190x30	Ø160-170	1930lm	0.50	24PCS
DL210-6-25W	25W	Ø190x30	Ø160-170	2750lm	0.50	24PCS
DL210-8-25W	25W	Ø225x34	Ø200-210	2750lm	0.65	12PCS
DL210-8-35W	35W	Ø225x34	Ø200-210	3900lm	0.65	12PCS
DL210-8-42W	42W	Ø225x34	Ø200-210	4750lm	0.65	12PCS

CCT 3000K 4000K 5000K 5700K

Trim White Black

DL216 Downlight

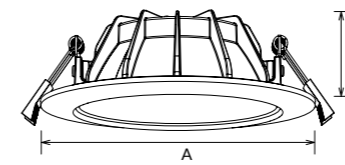

DL216 LED downlight is with high lumen SMD LED, die casting aluminum ADC12, PC lamp cover, external driver. Deep trim design provides soft lighting for eyes. 3CCT changeable with slide switch is available. IP44 waterproof for front side.

- ▶ 90° Beam Angle, IP20/IP44
- ▶ DIM, DALI, 0-10V, Flicker Free, SLIDE SWITCH
- ▶ AC 200-240V, PF≥0.9, CRI≥80
- ▶ SAA, RoHS, CE

Code	Watt	Size(AxBmm)	Cut-out(mm)	Lumen(±5%)	N.W/pc(kgs)	Q'ty/CTN
DL216-3-8W	8W	Ø115x45	Ø90-105	790lm	0.20	36PCS
DL216-3.5-10W	10W	Ø129x45	Ø105-115	1045lm	0.24	36PCS
DL216-4-13W	13W	Ø152x48	Ø125-140	1355lm	0.30	24PCS
DL216-5-20W	20W	Ø175x52	Ø145-160	2090lm	0.40	12PCS
DL216-7-25W	25W	Ø203x56	Ø175-190	2610lm	0.50	12PCS
DL216-7-30W	30W	Ø203x56	Ø175-190	2950lm	0.50	12PCS
DL216-8-33W	33W	Ø228x63	Ø205-215	3445lm	0.65	6PCS
DL216-8-40W	40W	Ø228x63	Ø205-215	4000lm	0.65	6PCS

CCT 3000K 4000K 5000K 5700K

Trim White Black



DL97 Downlight

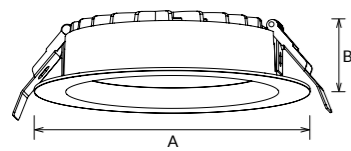

DL97 LED downlight is with high lumen SMD LED, die casting aluminum ADC12, external driver, IP54 IK06 protection level. CCT changeable by slide switch is available. Full size from 2.5 inch to 8 inch are all available.

- 90° beam angle, IP20/IP54 protection
- DIM, DALI, 0-10V, TUNABLE WHITE, Flicker Free, SLIDE SWITCH 3 in 1
- 2.4G, WIFI, Bluetooth, Smart Lighting
- AC 100-240V, AC 200-240V, PF≥0.9, CRI≥80
- SAA, RoHS, CE, CB

Code	Watt	Size(AxBmm)	Cut-out(mm)	Lumen(±5%)	N.W/pc(kgs)	Q'ty/CTN
-2.5-7W	7W	Ø85x39	Ø70-75	590lm	0.20	50PCS
DL97-3-10W	10W	Ø110x38	Ø90-95	980lm	0.25	36PCS
DL97-3-13W	13W	Ø110x38	Ø90-95	1300lm	0.25	36PCS
DL97-3.5-13W	13W	Ø120x45	Ø100-110	1230lm	0.31	30PCS
DL97-4-15W	15W	Ø145x45	Ø120-130	1600lm	0.46	30PCS
DL97-5-18W	18W	Ø170x45	Ø140-150	2070lm	0.52	30PCS
DL97-6-18W	18W	Ø190x45	Ø160-170	1900lm	0.66	20PCS
DL97-6-25W	25W	Ø190x45	Ø160-170	2680lm	0.66	20PCS
DL97-6-35W	35W	Ø190x45	Ø160-170	3900lm	0.66	20PCS
DL97-8-18W	18W	Ø228x45	Ø200-210	2050lm	0.81	10PCS
DL97-8-25W	25W	Ø228x45	Ø200-210	2650lm	0.81	10PCS
DL97-8-35W	35W	Ø228x45	Ø200-210	4025lm	0.81	10PCS

CCT 3000K 4000K 5000K 5700K

Trim White Black

CL59 Downlight

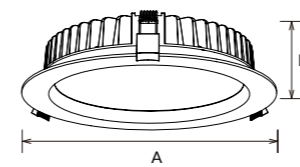

CL59 LED downlight is with high lumen SMD LED, die casting aluminum ADC12, external driver, IP20 or IP44 available. CCT changeable by slide switch is available. Full size from 2 inch to 10 inch are all available.

- 90° beam angle, IP20/IP44 protection
- DIM, DALI, 0-10V, TUNABLE WHITE, DIM TO WARM, Flicker Free
- SLIDE SWITCH 3 in 1, Bluetooth, CASAMBI
- AC 100-240V, AC 200-240V, PF≥0.9, CRI≥80
- SAA, RoHS, CE

Code	Watt	Size(AxBmm)	Cut-out(mm)	Lumen(±5%)	N.W/pc(kgs)	Q'ty/CTN
CL59-2-7W	7W	Ø80x39	Ø60-70	480lm	0.28	50PCS
CL59-2-7W	7W	Ø80x39	Ø60-65	550lm	0.24	50PCS
CL59-2.5-7W	7W	Ø85x39.5	Ø68-75	680lm	0.26	50PCS
CL59-2.5-10W	10W	Ø85x39.5	Ø70-75	730lm	0.24	50PCS
CL59-3-10W/-F	10W	Ø100x38	Ø90-100	720lm	0.28	24PCS
CL59-3-10W	10W	Ø100x38	Ø90-95	1110lm	0.28	24PCS
CL59-3-12W/13W/-F	12W/13W	Ø110x38	Ø90-100	1170lm/950lm	0.28	24PCS
CL59-3.5-13W	13W	Ø120x39	Ø100-110	1150lm	0.45	24PCS
CL59-4-12W	12W	Ø145x45	Ø120-130	1480lm	0.59	30PCS
CL59-4-13W/18W	13W/18W	Ø145x45	Ø120-130	950lm/1450lm	0.59	30PCS
CL59-5-18W	18W	Ø170x45	Ø140-150	1550lm	0.70	30PCS
CL59-5-18W	18W	Ø170x45	Ø140-150	2300lm	0.70	30PCS
CL59-5-25W	25W	Ø170x45	Ø140-150	2100lm	0.70	30PCS
CL59-6-18W	18W	Ø190x45	Ø160-170	1560lm	0.83	20PCS
CL59-6-18W	18W	Ø190x45	Ø160-170	2250lm	0.83	20PCS
CL59-6-25W/35W	25W/35W	Ø190x45	Ø160-170	2130lm/2830lm	0.83	20PCS
CL59-8-18W/35W	18W/35W	Ø228x45	Ø200-210	1540lm/2790lm	0.94	10PCS
CL59-8-25W	25W	Ø228x45	Ø200-210	2130lm	0.94	10PCS
CL59-8-25W	25W	Ø228x45	Ø200-210	3150lm	0.94	10PCS
CL59-10-35W	35W	Ø280x52	Ø230-260	4680lm	1.60	10PCS
CL59-10-45W	45W	Ø280x52	Ø230-260	4170lm	1.60	10PCS

CCT 3000K 4000K 5000K 5700K

Trim White Black Silver Chrome



DL110 Downlight

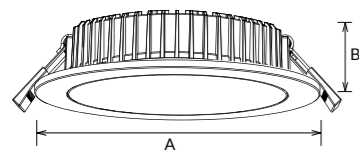

DL110 LED downlight is with high lumen SMD LED, die casting aluminum ADC12, external driver. IP65 waterproof for indoor and outdoor use.

- ▶ 90°
- ▶
- ▶
- ▶



Code	Watt	Size(AxBmm)	Cut-out(mm)	Lumen(±5%)	N.W/pc(kgs)	Q'ty/CTN
DL110-3-13W	13W	Ø115x55.5	Ø95-100	1320lm	0.40	24PCS
DL110-4-18W	18W	Ø155x67	Ø120-130	1830lm	0.61	24PCS
DL110-6-25W	25W	Ø195x46.5	Ø175-185	2550lm	0.75	12PCS
DL110-8-35W	35W	Ø235x54.5	Ø205-215	3570lm	1.08	12PCS

CCT — 3000K 4000K 5000K 5700K Trim — White Black Silver Chrome

DL317 Downlight

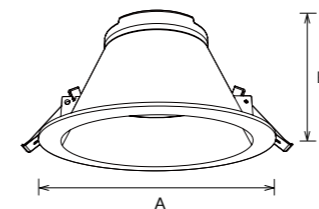

DL317 LED downlight adopts high lumen SMD LED, PC diffuser with even light output. Aluminum coated plastic housing has been deepened to reduce the glare. Dimmable flicker free driver shares great popularity by the excellent dimming effect. Interchangeable CCT with slide switch is available, IP54 waterproof for front side.

- ▶ 90°
- ▶
- ▶
- ▶



Code	Watt	Size(AxBmm)	Cut-out(mm)	Lumen(±5%)	N.W/pc(kgs)	Q'ty/CTN
DL317-3-10W	10W	Ø115x70.5	Ø90-95	910lm	0.20	30PCS
DL317-6-16W	16W	Ø190x102	Ø160-170	1660lm	0.40	12PCS
DL317-8-20W	20W	Ø240x117	Ø200-210	2250lm	0.56	12PCS

CCT — 3000K 4000K 5000K 5700K Trim — White Black



ONLY BRIGHT
NO LIGHT

DL161 Downlight

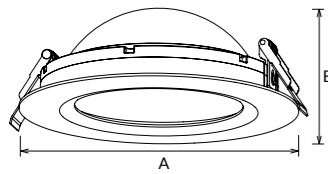

DL161 LED downlight is with high lumen SMD LED, die casting aluminum ADC12, external driver. Special appearance and Indirect lighting design provides even and soft lighting.

- ▶ 120° IP20
- ▶ DIM DALI 0-10V Flicker Free
- ▶ AC 200-240V PF≥0.9 CRI≥80
- ▶ SAA RoHS CE

Code	Watt	Size(AxBmm)	Cut-out(mm)	Lumen(±5%)	N.W/pc(kgs)	Q'ty/CTN
DL161-6-10W	10W	Ø185x67	Ø160-170	700lm	0.42	12PCS
DL161-8-20W	20W	Ø228x88.4	Ø200-210	1520lm	0.59	12PCS

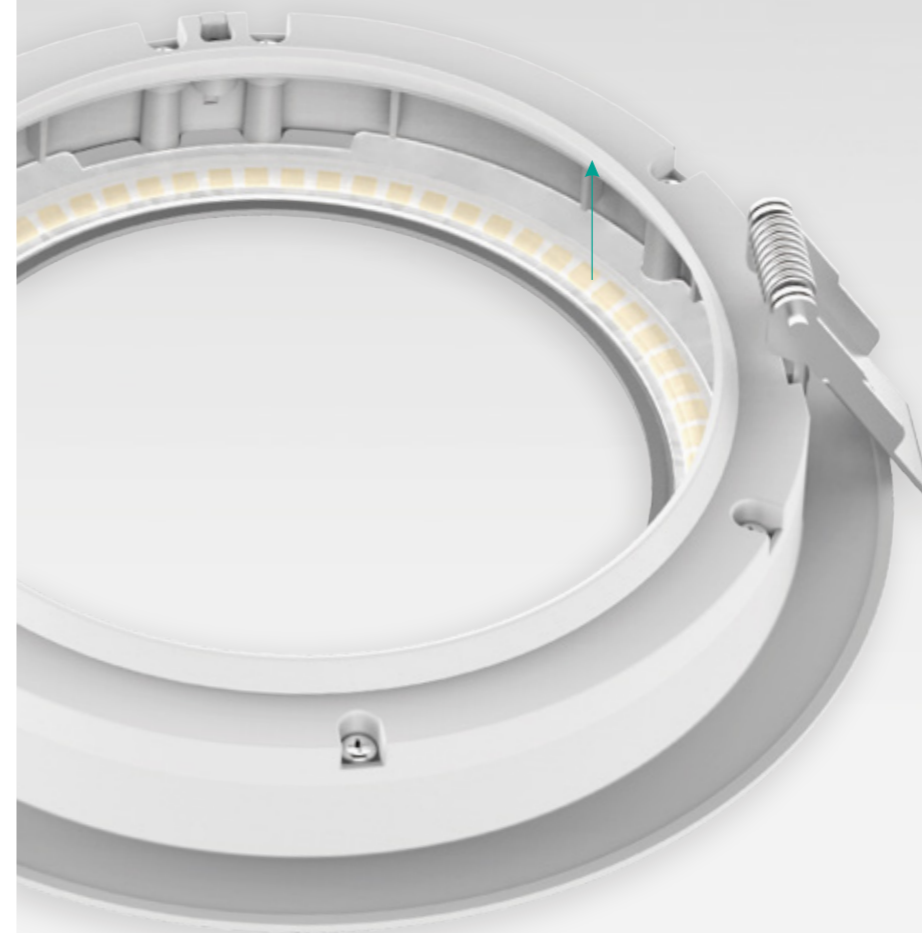

No diffuser covered, it diffuses the light source on the concave sphere heatsink

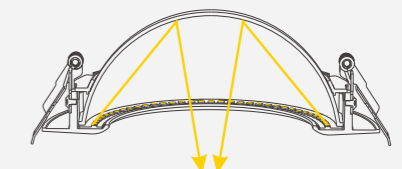

CCT ——— 3000K 4000K 5000K 5700K

Trim ——— White

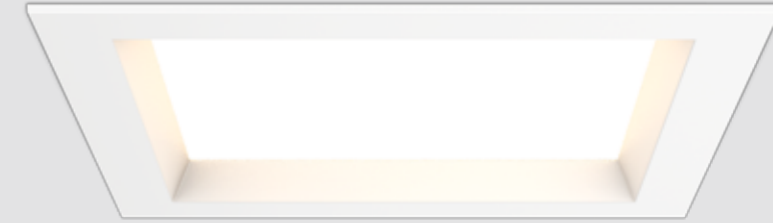
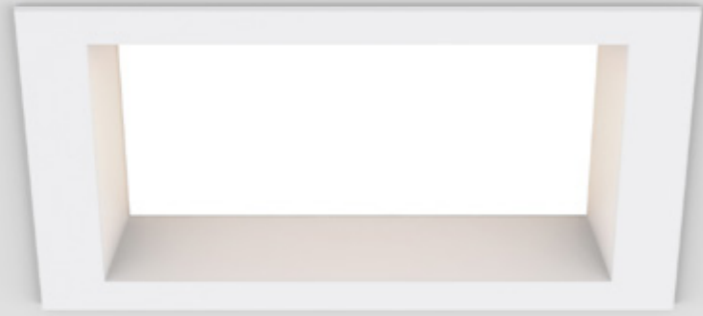

DL308B NEW Downlight

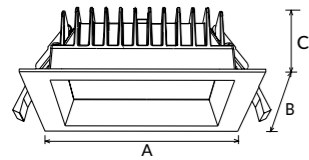

DL308B LED downlight as square design is with high lumen SMD LED, die casting aluminum ADC12, external driver, IP54 protection level. CCT changeable by slide switch is available.

- ▶ 90° IP20 / IP54
- ▶ DIM 0-10V Flicker Free SLIDE SWITCH 3 in 1
- ▶ AC 220-240V PF≥0.9 CRI≥80
- ▶ SAA RoHS CE



Code	Watt	Size(AxBxCmm)	Cut-out(mm)	Lumen(±5%)	N.W/pc(kgs)	Q'ty/CTN
DL308B-3-10W	10W	110x110x52	90x90(95x95)	120lm	0.26	24PCS
DL308B-4-12W	12W	145x145x53	120x120(130x130)	130lm	0.40	18PCS
DL308B-4-18W	18W	145x145x53	120x120(130x130)	130lm	0.40	18PCS
DL308B-6-18W	18W	190x190x53	160x160(170x170)	130lm	0.58	12PCS
DL308B-6-25W	25W	190x190x53	160x160(170x170)	130lm	0.58	12PCS

CCT 3000K 4000K

Trim White

DL34 Downlight

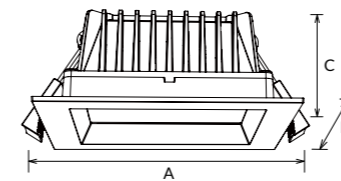

DL34 LED downlight with high lumen SMD LED, square shape, ADC12 aluminum heat sink, external driver. IP20/IP44 waterproof available.

- ▶ 90° IP20 / IP44
- ▶ DIM DALI 0-10V Flicker Free SLIDE SWITCH 3 in 1
- ▶ AC 100-240V AC 200-240V PF≥0.9 CRI≥80
- ▶ SAA RoHS CE

Code	Watt	Size(AxBxCmm)	Cut-out(mm)	Lumen(±5%)	N.W/pc(kgs)	Q'ty/CTN
DL34-3-13W	13W	110x110x44	90-95	940lm	0.40	24PCS
DL34-6-25W	25W	190x190x54	160-170	2300lm	1.11	12PCS

CCT 3000K 4000K 5000K 5700K

Trim White Black Silver

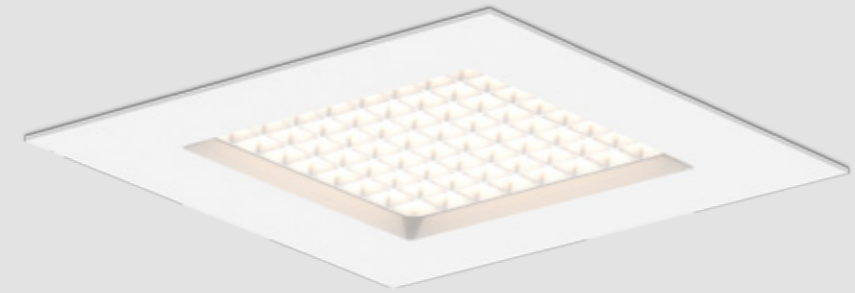

DL96 Downlight

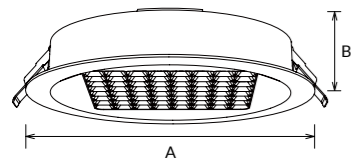

DL96 LED downlight with SMD LED, Aluminum coated plastic, round shape, internal driver. IP54 waterproof. Grilling design effectively reduce the UGR index. High lumen output 110lm/W. Push button looping connection terminal saves much installation time.

- ▶ 90° IP40 / IP54
- ▶ DIM Flicker Free
- ▶ AC 100-277V AC 200-240V PF≥0.9 CRI≥80
- ▶ SAA RoHS CE

Code	Watt	Size(AxBmm)	Cut-out(mm)	Lumen(±5%)	N.W/pc(kgs)	Q'ty/CTN
DL96-3-10W	10W	Ø110x40	Ø90-95	1070lm	0.22	30PCS
DL96-6-18W	18W	Ø190x40	Ø160-170	2070lm	0.44	24PCS
DL96-8-25W	25W	Ø228x40	Ø200-210	3000lm	0.70	20PCS

CCT 3000K 4000K 5000K 5700K

Trim White Silver

DL105 Downlight

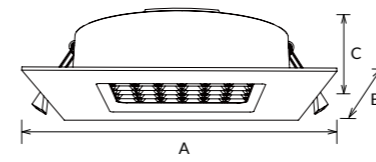

DL105 LED downlight with SMD LED, plastic coated aluminum, square shape, internal driver. IP54 waterproof. Grilling design effectively reduce the UGR index. High lumen output 110lm/W. Push button looping connection terminal saves much installation time.

- ▶ 90° IP40 / IP54
- ▶ DIM Flicker Free
- ▶ AC 100-277V AC 200-240V PF≥0.9 CRI≥80
- ▶ SAA RoHS CE

Code	Watt	Size(AxBxCmm)	Cut-out(mm)	Lumen(±5%)	N.W/pc(kgs)	Q'ty/CTN
DL105-3-10W	10W	110x110x39	90-95	1070lm	0.24	30PCS
DL105-6-18W	18W	190x190x43.5	160-170	2070lm	0.54	24PCS
DL105-8-25W	25W	228x228x43.5	200-210	3000lm	0.84	20PCS

CCT 3000K 4000K 5000K 5700K

Trim White Silver

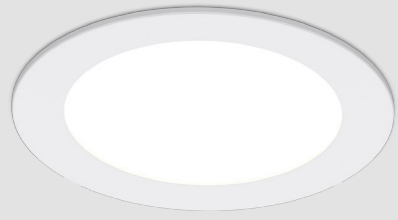

DL137A



DL137B



DL137 Downlight

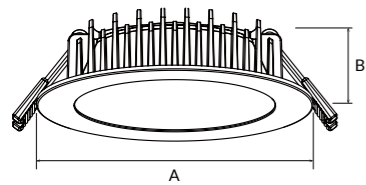

DL137A flat cover & DL137B step cover, super slim downlight. It adopts high lumen SMD LED, PC diffuser with even light output and plastic coated aluminum housing with external driver design. It is IP54 for LED cover part and can do CCT changeable.

- ▶ 100° Beam Angle, IP20/IP54
- ▶ DIM, Flicker Free, SLIDE SWITCH 3 in 1
- ▶ AC 220-240V, PF≥0.9, CRI≥80
- ▶ SAA, RoHS, CE



Code	Watt	Size(AxBmm)	Cut-out(mm)	Lumen(±5%)	N.W/pc(kgs)	Q'ty/CTN
DL137A-3-8W	8W	Ø110x30	Ø90-95	910lm	0.20	36PCS
DL137B-3-8W	8W	Ø110x36	Ø90-95	900lm	0.21	36PCS
DL137B-4-13W NEW	13W	Ø145x46	Ø120-130	1300lm	0.26	40PCS
DL137B-4-18W NEW	18W	Ø145x46	Ø120-130	1800lm	0.26	40PCS
DL137B-5-18W NEW	18W	Ø170x46	Ø140-150	1800lm	0.31	40PCS
DL137B-5-25W NEW	25W	Ø170x46	Ø140-150	2500lm	0.31	40PCS
DL137B-6-18W NEW	18W	Ø190x46	Ø160-170	1800lm	0.38	36PCS
DL137B-6-25W NEW	25W	Ø190x46	Ø160-170	2500lm	0.38	36PCS
DL137B-6-30W NEW	30W	Ø190x46	Ø160-170	3000lm	0.38	36PCS
DL137B-8-18W NEW	18W	Ø235x46	Ø200-210	1800lm	0.60	36PCS
DL137B-8-25W NEW	25W	Ø235x46	Ø200-210	2500lm	0.60	36PCS
DL137B-8-35W NEW	35W	Ø235x46	Ø200-210	3500lm	0.60	36PCS

CCT 3000K 4000K 5000K 5700K

Trim White Black

CL22 Downlight

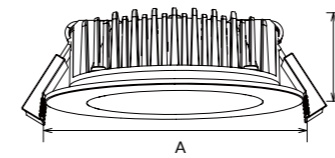

CL22 LED downlight is with high lumen SMD LED, PMMA diffuser, external driver, IP20 or IP44 available. CCT changeable by slide switch is available.

- ▶ 90° Beam Angle, IP20
- ▶ DIM, DALI, 0-10V, DIM TO WARM, Flicker Free
- ▶ SLIDE SWITCH 3 in 1, 2.4G, WIFI
- ▶ AC 100-240V, PF≥0.9, CRI≥80
- ▶ SAA, RoHS, CE

Code	Watt	Size(AxBmm)	Cut-out(mm)	Lumen(±5%)	N.W/pc(kgs)	Q'ty/CTN
CL22-2.5-7W	7W	Ø85x31	Ø70-75	480lm	0.35	50PCS
CL22-2.5-10W	10W	Ø85x31	Ø70-75	740lm	0.35	50PCS
CL22-3-10W	10W	Ø104x31	Ø90-95	900lm	0.38	24PCS
CL22-3-13W	13W	Ø104x31	Ø90-95	1075lm	0.38	24PCS

CCT 3000K 4000K 5000K 5700K

Trim White Black Silver Chrome



DL147C Downlight

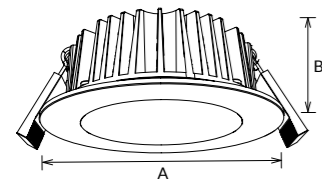

DL147C LED downlight is with high lumen SMD LED, ADC7 lamp body and frame, PC lamp cover, external driver, IP20 IK06 protection. CCT changeable by slide switch. Round frame for options.

- ▶ 90°
- ▶
- ▶
- ▶

Code	Watt	Size(AxBmm)	Cut-out(mm)	Lumen(±5%)	N.W/pc(kgs)	Q'ty/CTN
DL147C-3-10W	10W	Ø103x38	Ø90-95	1000lm	0.32	24PCS

DL147F Downlight

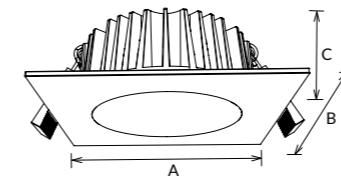

DL147F LED downlight is with high lumen SMD LED, ADC7 lamp body and frame, PC lamp cover, external driver, IP20 IK06 protection. CCT changeable by slide switch. Square frame for options.

- ▶ 90°
- ▶
- ▶
- ▶

Code	Watt	Size(AxBxCmm)	Cut-out(mm)	Lumen(±5%)	N.W/pc(kgs)	Q'ty/CTN
DL147F-3-10W	10W	104x104x38	Ø90-95	1000lm	0.34	24PCS





DL141 Downlight

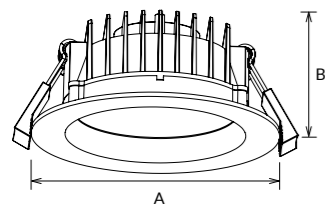

DL141 LED downlight is with high lumen SMD LED, plastic coated aluminum lamp body, and PC frame, external driver, IP54 IK08 protection available. CCT changeable by slide switch.

- ▶ 90° IP20
IP54
- ▶ DIM Flicker Free SLIDE SWITCH 3 in 1 WIFI RGB
- ▶ Smart Lighting
- ▶ AC 200-240V PF≥0.9 CRI≥80
- ▶ SAA RoHS CE

Code	Watt	Size(AxBmm)	Cut-out(mm)	Lumen(±5%)	N.W/pc(kgs)	Q'ty/CTN
DL141-3-10W	10W	Ø110x39.5	Ø90-100	830lm	0.18	24PCS
DL141B-3-10W	10W	Ø110x48	Ø90-100	950lm	0.21	24PCS

CCT ——— 3000K 4000K 5000K 5700K

Trim ——— White Black

IP54 FRONT TRI-COLOR DOWNLIGHT

Creating fantastic atmosphere by flexible CCT changing between Warm white, natural white and day light.

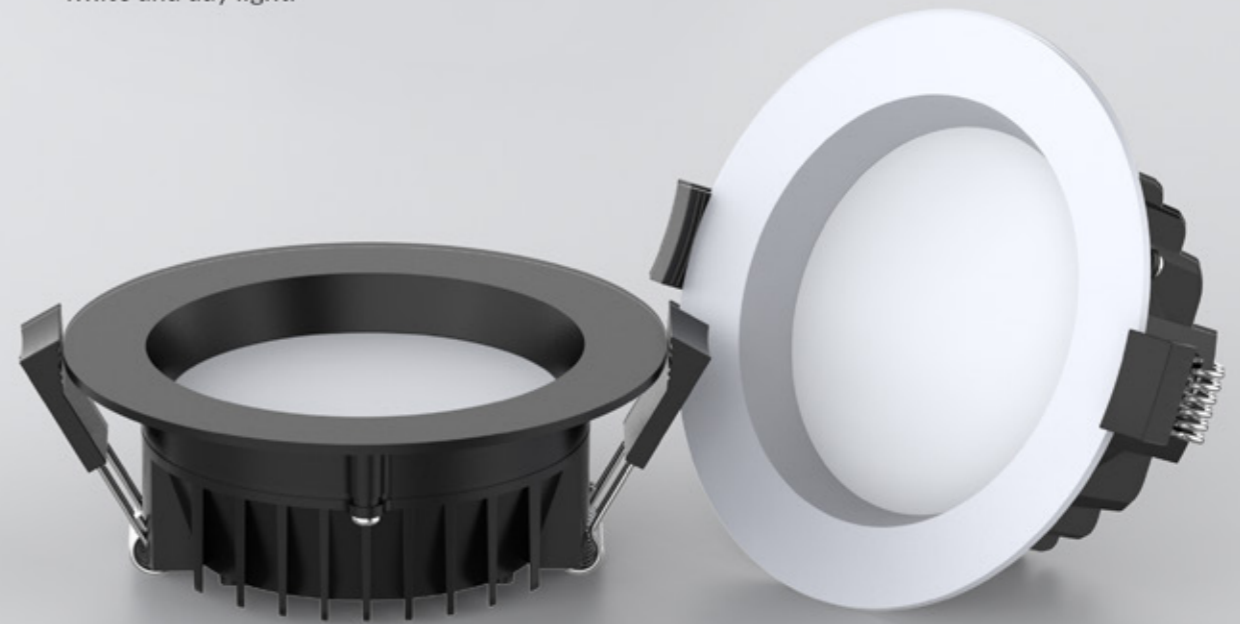
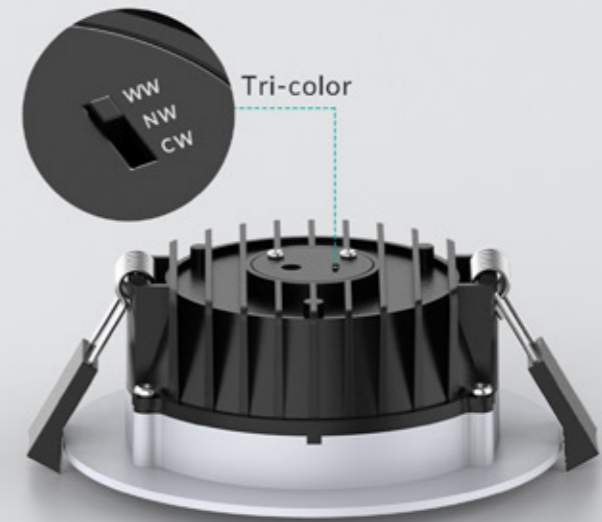



DL359A



DL359B



DL359C

DL359 Downlight

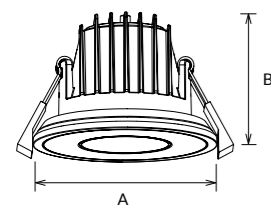

DL359 downlight is a deep reflector anti-glare downlight as external driver. DL359A with COB light source only, DL359B/C with COB+SMD as ambient lighting, COB main light source is UGR<16 with narrow beam angle. Both light sources can be controlled separately with the special designed power supply, which can meet multiple scene applications, users will also have a comfortable visual experience. ADC12 aluminum housing has good heat dissipation.

- ▶
- ▶
- ▶
- ▶

Code	Watt	Size(AxBmm)	Cut-out(mm)	Lumen(±5%)	N.W/pc(kgs)	Q'ty/CTN
DL359A-2.5-8W	8W	Ø90x62	Ø68-75	870lm	0.26	30PCS
DL359A-2.5-10W	10W	Ø90x62	Ø68-75	1090lm	0.26	30PCS
DL359A-3-10W	10W	Ø105x70	Ø90-95	1190lm	0.31	30PCS
DL359A-3-13W	13W	Ø105x70	Ø90-95	1530lm	0.31	30PCS
DL359B-2.5-8W	8W	Ø90x62	Ø68-75	640lm	0.26	30PCS
DL359B-2.5-10W	10W	Ø90x62	Ø68-75	740lm	0.26	30PCS
DL359B-3-10W	10W	Ø105x70	Ø90-95	890lm	0.31	30PCS
DL359B-3-13W	13W	Ø105x70	Ø90-95	1120lm	0.31	30PCS
DL359C-2.5-8W	8W	Ø90x62	Ø68-75	690lm	0.3	30PCS
DL359C-2.5-10W	10W	Ø90x62	Ø68-75	820lm	0.3	30PCS
DL359C-3-10W	10W	Ø105x70	Ø90-95	1050lm	0.35	30PCS
DL359C-3-13W	13W	Ø105x70	Ø90-95	1330lm	0.35	30PCS

CCT — 2700K — 3000K — 4000K — 5000K

Trim — White Black

MAIN LIGHT+ NIGHT LIGHT



DL359A
COB UGR<16



DL359B
COB+SMD



DL359C
COB+SMD
Wall switch mode

DL359C 3-Step Mood Maker

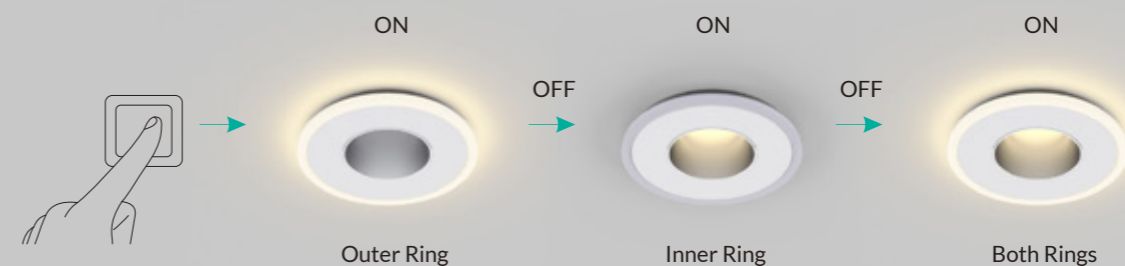



DL368 Downlight

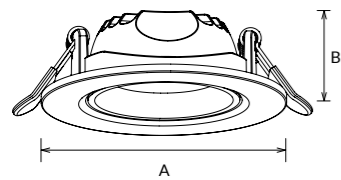

DL368 downlight is a super slim design with only 35mm height as external driver, and it adopts ADC12 die-casting aluminum housing, which increases the air contact surface, so that accelerates air circulation and approved by IC-4@Ta 40C°. It can be tilted 25 degrees, and CCT interchangeable.

- ▶ 36° 60°
- ▶ 25°
- ▶ IP20 IP40
- ▶ DIM DALI 0-10V Flicker Free SLIDE SWITCH 3 in 1
- ▶ AC 220-240V PF≥0.85 CRI≥80
- ▶ SAA RoHS CE

Code	Watt	Size(AxBmm)	Cut-out(mm)	Lumen(±5%)	N.W/pc(kgs)	Q'ty/CTN
DL368-2.5-6W	6W	Ø85x31	Ø68-75	680lm	0.14	36PCS
DL368-3-9W	9W	Ø105x35	Ø83-95	1050lm	0.19	36PCS

CCT ——— 3000K 4000K 5000K 5700K

Trim ——— White Black

SLIM TILTED DOWNLIGHT



< 35mm >

< 31mm >

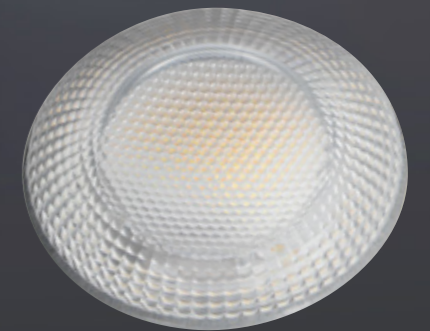

Anti-glare lens

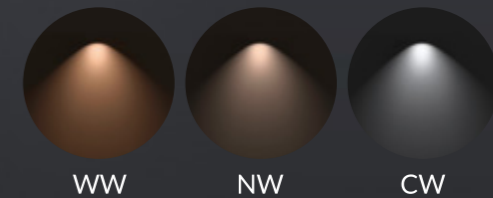

IC-4@Ta 40°C approved

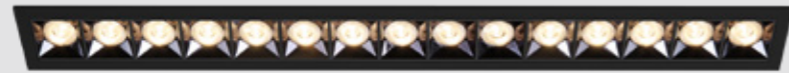

DL248A Downlight

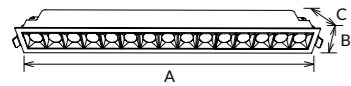

DL248A is linear recessed downlight with symmetric beam, adopting CREE XP-G big power SMD light source with high lumen, CRI>90, SDCM<6. The aluminum die-casting frame with UV-proof white powder coating finishing provides an excellent thermal management. External flicker free driver and UGR<19 are available.

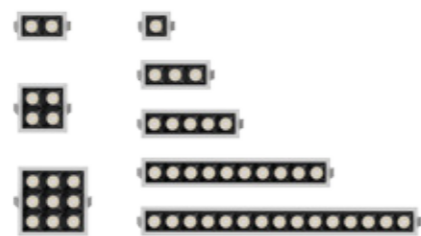
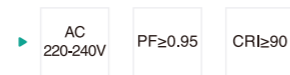
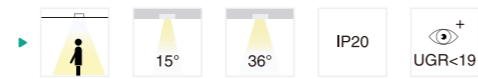

Code	Watt	Size(AxBxCmm)	Cut-out(mm)	Lumen(±5%)	N.W/pc(kgs)	Q'ty/CTN
DL248A-45-4W	4W	45×45×42	37×37	220lm	0.12	75PCS
DL248A-76-6W	6W	76×45×51	68×37	440lm	0.16	75PCS
DL248A-105-9W	9W	105×45×51	97×37	670lm	0.21	50PCS
DL248A-75-11W	11W	75×75×51	67×67	870lm	0.22	60PCS
DL248A-147-13W	13W	147×45×51	139×37	1080lm	0.27	40PCS
DL248A-105-23W	23W	105×105×51	97×97	1960lm	0.43	30PCS
DL248A-280-25W	25W	280×45×51	272×37	2150lm	0.51	20PCS
DL248A-413-37W	37W	413×45×51	405×37	3100lm	0.71	20PCS

CCT 2700K 3000K 4000K

Trim White Black



DL248B Downlight



DL248B is linear recessed downlight with asymmetric beam, adopting CREE XP-G big power SMD light source with high lumen, CRI>90, SDCM<6. The aluminum die-casting frame with UV-proof white powder coating finishing provides an excellent thermal management. External flicker free driver is available.

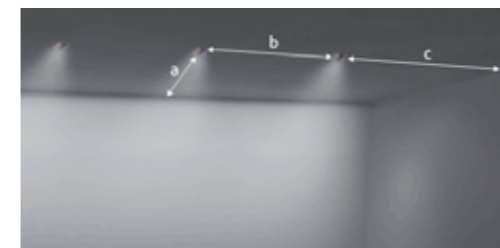
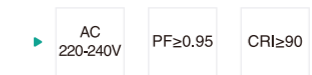

Code	Size a(mm)	Size b(mm)	Size c(mm)
UP-DL248B-105-9W	600	800	400
UP-DL248B-147-13W	600	800	400
UP-DL148B-280-25W	600	900	450
UP-DL248B-413-37W	600	1000	500

Code	Watt	Size(AxBxCmm)	Cut-out(mm)	Lumen(±5%)	N.W/pc(kgs)	Q'ty/CTN
DL248B-105-9W	9W	105×45×55	97×37	380lm	0.21	50PCS
DL248B-147-13W	13W	147×45×55	139×37	690lm	0.27	40PCS
DL248B-280-25W	25W	280×45×55	272×37	1300lm	0.51	20PCS
DL248B-413-37W	37W	413×45×55	405×37	2000lm	0.70	20PCS

CCT 2700K 3000K 4000K

Trim White Black



DL222 Downlight

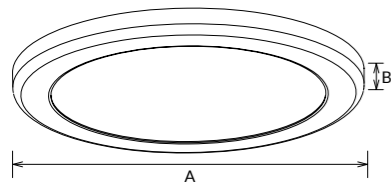

DL222 LED downlight with SMD LED, AL1060 Aluminum lamp body, AC to DC internal driver, round shape. Recessed and surface mounted installation are available. Cutout size is adjustable from 65mm to 205mm for recessed installation. CCT and power is switchable for choice.

-
-
-
-
-
-
-
-
-
-
-
-
-
-
-

Code	Watt	Size(AxBmm)	Cut-out(mm)	Lumen(±5%)	N.W/pc(kgs)	Q'ty/CTN
DL222-8-16W	16W	Ø235x16	Ø65-205	1800lm	0.36	20PCS
DL222-8-16W-A3	10W/13W/16W	Ø235x16	Ø65-205	1800lm	0.36	20PCS
DL222-10-22W	22W	Ø300x20	Ø120-260	2600lm	0.68	10PCS
DL222-10-22W-A3	16W/20W/22W	Ø300x20	Ø120-260	2600lm	0.68	10PCS
DL222-10-22W-S	22W	Ø300x20	Ø120-260	2600lm	0.68	10PCS

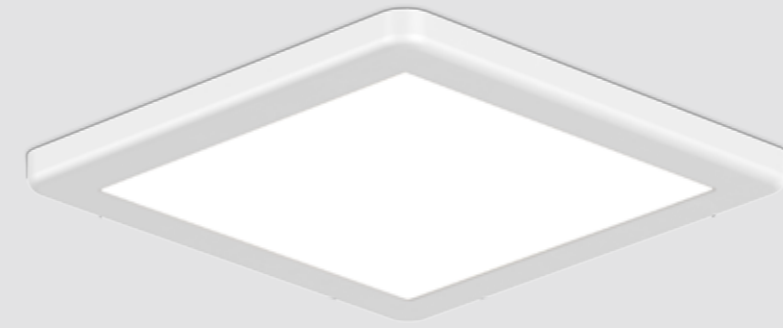

DL222B Downlight

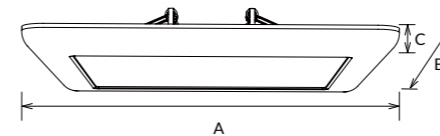

DL222B LED downlight with SMD LED, AL1060 aluminum lamp body, AC to DC internal driver, square shape. Recessed and surface mounted installation are available. Cutout size is adjustable from 65mm to 205mm for recessed installation. CCT and power is switchable for choice.

-
-
-
-
-
-
-
-
-
-
-
-
-
-

Code	Watt	Size(AxBxCmm)	Cut-out(mm)	Lumen(±5%)	N.W/pc(kgs)	Q'ty/CTN
DL222B-8-16W	16W	235x235x16	Ø65-205	1650lm	0.55	20PCS
DL222B-8-16W-D	16W	235x235x16	Ø65-205	1650lm	0.55	20PCS
DL222B-8-16W-A3	10W/13W/16W	235x235x16	Ø65-205	1800lm	0.55	20PCS
DL222B-8-16W-C3	16W	235x235x16	Ø65-205	1800lm	0.55	20PCS
DL222B-8-16W-P3	16W	235x235x16	Ø65-205	1800lm	0.55	20PCS
DL222B-8-16W-AC3	10W/13W/16W	235x235x16	Ø65-205	1800lm	0.55	20PCS



DL280A



DL280B

DL280 Downlight

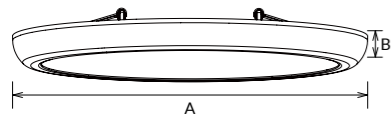

DL280 is a downlight with adjustable cutout from 65~205mm and 120~260mm for recessed installation. Super slim with internal driver and quick connector makes installation easy. Interchangeable CCT and power with slide switch are available. Triac dimmable and flicker free are used.

- ▶
- ▶
- ▶
- ▶

Code	Watt	Size(AxBmm)	Cut-out(mm)	Lumen(±5%)	N.W/pc(kgs)	Q'ty/CTN
DL280-8-16W	16W	Ø235x22	Ø65-205	1700lm	0.46	20PCS
DL280-10-22W	22W	Ø300x25	Ø120-260	2600lm	0.78	10PCS

CCT — 3000K — 4000K — 5000K — 5700K

Trim — White

ULTRA SLIM DESIGN



DL280B



DL280A



Adjustable cutout 65~205mm, 120~260mm



Surface mounted

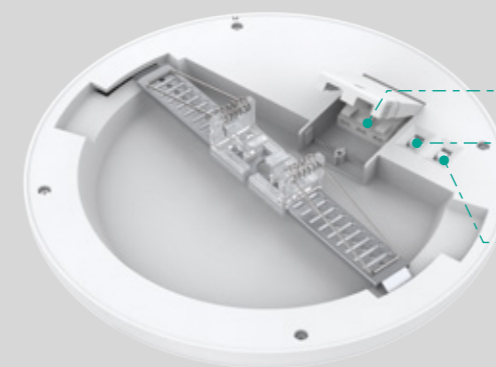

Quick connector design

10W 13W 16W (8inch)
16W 20W 22W (10inch)

CCT changeable (WW NW CW)



DL134 Downlight

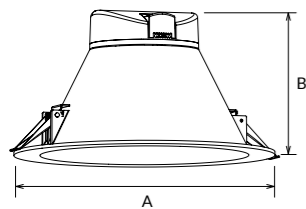

DL134 LED downlight with SMD LED, plastic coated aluminum heat sink, internal driver. Deep trim design provides soft lighting. IP54 waterproof for internal use. CCT switchable by slide switch is available.

- ▶
- ▶
- ▶
- ▶

Code	Watt	Size(AxBmm)	Cut-out(mm)	Lumen(±5%)	N.W/pc(kgs)	Q'ty/CTN
DL134-3-10W	10W	Ø115x83.4	Ø90-95	880lm	0.17	36PCS
DL134-4-13W	13W	Ø145x97.5	Ø125-130	1230lm	0.25	24PCS
DL134-6-16W	16W	Ø190x115.3	Ø160-170	1720lm	0.40	12PCS
DL134-8-20W	20W	Ø240x132.5	Ø200-210	2150lm	0.55	12PCS

CCT ——— 3000K 4000K 5000K 5700K

Trim ——— White Silver





DL304 Downlight

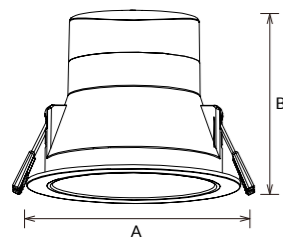

DL304 LED downlight is a fixed design as built-in driver. It adopts high efficiency SMD chip, anti-glare lens with uniform light output and soft UGR<19 as black, UGR<23 as white effect. IP54 in front part, IK06 protection level, and interchangeable CCT with slide switch are available. DL304A with fast connector, DL304B with Australia plug

- ▶ 36° 45° 60°
- ▶ IP20 IP54
- ▶ UGR<19
- ▶ UGR<23
- ▶ DIM
- ▶ Flicker Free
- ▶ SLIDE SWITCH 3 in 1
- ▶ AC 220-240V
- ▶ PF≥0.9
- ▶ CRI≥80
- ▶ SAA
- ▶ RoHS
- ▶ CE

Code	Watt	Size(AxBmm)	Cut-out(mm)	Lumen(±5%)	N.W/pc(kgs)	Q'ty/CTN
DL304A-2.5-6W	6W	Ø85x84	Ø70-75	655lm	0.13	30PCS
DL304A-3-8W	8W	Ø106x84	Ø90-95	950lm	0.17	30PCS
DL304B-3-8W	8W	Ø106x84	Ø90-95	950lm	0.21	30PCS

CCT — 3000K — 4000K — 5700K

Trim — White Black

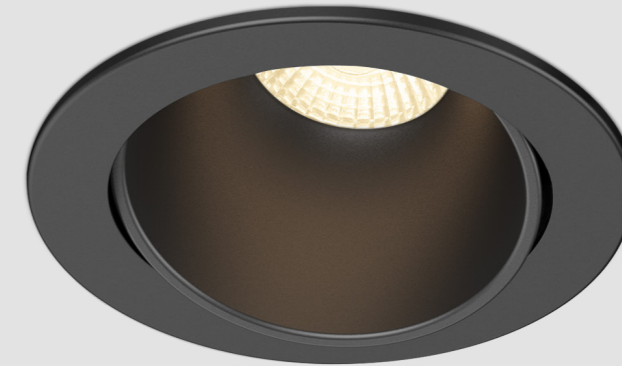

CL304 Downlight

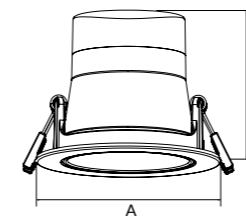

CL304 SMD downlight is 30 degrees tilted design as built-in driver. It adopts high lumen SMD LED, PC diffuser with even light output. Plastic coated aluminum housing with deep reflector design to reduce the glare, adjustable CCT for a wider application. Two types optional: Type A is with quick wire connector, Type B is with AU plug.

- ▶ 45° 60° 30°
- ▶ IP20 IP54
- ▶ UGR<19
- ▶ UGR<25
- ▶ DIM
- ▶ Flicker Free
- ▶ SLIDE SWITCH 3 in 1
- ▶ AC 220-240V
- ▶ PF≥0.9
- ▶ CRI≥80
- ▶ SAA
- ▶ RoHS
- ▶ CE

Code	Watt	Size(AxBmm)	Cut-out(mm)	Lumen(±5%)	N.W/pc(kgs)	Q'ty/CTN
CL304A-3-8W	8W	Ø106x84	Ø90-95	950lm	0.17	30PCS
CL304B-3-8W	8W	Ø106x84	Ø90-95	950lm	0.21	30PCS

CCT — 3000K — 4000K — 5700K

Trim — White Black



DL54 Downlight

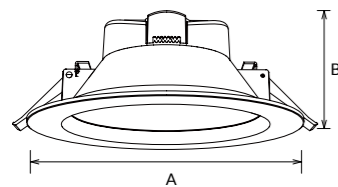

DL54 LED downlight with SMD LED, plastic coated aluminum heat sink, internal driver. IP40/IP54 available for choice. CCT switchable by slide switch is available.

- ▶
- ▶
- ▶
- ▶

Code	Watt	Size(AxBmm)	Cut-out(mm)	Lumen(±5%)	N.W/pc(kgs)	Q'ty/CTN
DL54C-2.5-7W-P3	7W	Ø85x68	Ø68-75	700lm	0.12	50PCS
DL54C-3-8W	8W	Ø115x58	Ø90-95	750lm	0.20	30PCS
DL54C-3-8W-C3(P3)	8W	Ø115x61	Ø90-95	750lm	0.20	30PCS
DL54C-3-10W	10W	Ø115x58	Ø90-95	940lm	0.20	30PCS
DL54C-3-10W-C3(P3)	10W	Ø115x61	Ø90-95	940lm	0.20	30PCS
DL54B-4-13W	13W	Ø145x61	Ø120-130	1100lm	0.28	30PCS
DL54B-4-13W-C3(P3)	13W	Ø145x62.5	Ø120-130	1300lm	0.28	30PCS
DL54B-6-16W	16W	Ø190x74	Ø160-170	1550lm	0.51	30PCS
DL54B-6-16W-C3(P3)	16W	Ø190x75.5	Ø160-170	1760lm	0.41	30PCS
DL54B-8-20W	20W	Ø225x84	Ø200-210	1840lm	0.64	20PCS
DL54B-8-20W-C3(P3)	20W	Ø225x84	Ø200-210	2100lm	0.52	20PCS

CCT ——— 3000K 4000K 5000K 5700K

Trim ——— White

Ring ——— ACC-DL54 Nickel brushed

DL41 Downlight

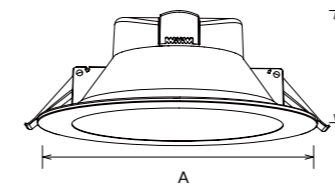

DL41 LED downlight with SMD LED, PC diffuser, plastic coated aluminum heat sink, internal driver. IP54 waterproof for cover. CCT switchable by slide switch is available.

- ▶
- ▶
- ▶
- ▶

Code	Watt	Size(AxBmm)	Cut-out(mm)	Lumen(±5%)	N.W/pc(kgs)	Q'ty/CTN
DL41C-2.5-7W	7W	Ø85x55	Ø70-75	620lm	0.12	50PCS
DL41C-2.5-7W-C3(P3)	7W	Ø85x63	Ø70-75	650lm	0.12	50PCS
DL41C-3-8W	8W	Ø115x58	Ø90-95	750lm	0.20	30PCS
DL41C-3-8W-C3(P3)	8W	Ø115x61	Ø90-95	800lm	0.20	30PCS
DL41C-3-10W	10W	Ø115x58	Ø90-95	880lm	0.20	30PCS
DL41C-3-10W-C3(P3)	10W	Ø115x61	Ø90-95	940lm	0.20	30PCS
DL41B-4-13W	13W	Ø145x61	Ø120-130	1210lm	0.22	30PCS
DL41B-4-13W-C3(P3)	13W	Ø145x62.5	Ø120-130	1320lm	0.22	30PCS
DL41B-6-16W	16W	Ø190x74	Ø160-170	1670lm	0.51	30PCS
DL41B-6-16W-C3(P3)	16W	Ø190x75.5	Ø160-170	1840lm	0.51	30PCS
DL41B-8-20W-C3(P3)	20W	Ø225x84	Ø200-210	2200lm	0.64	20PCS

CCT ——— 3000K 4000K 5000K 5700K

Trim ——— White

Ring ——— ACC-DL41-2.5/ ACC-DL41-3 Nickel brushed



DL41-S1 Downlight

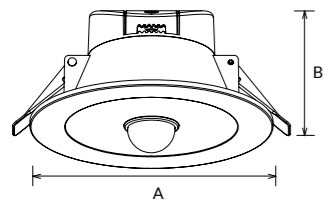

DL41-S1 LED downlight with PIR sensor function, SMD LED, PC diffuser, plastic coated aluminum heat sink, internal driver. IP54 waterproof for cover. CCT switchable by slide switch is available.

- ▶ 90°
- ▶ IP20
IP40
- ▶ Flicker Free
- ▶ SLIDE SWITCH 3 in 1
- ▶ PIR Sensor
- ▶ AC 200-240V
- ▶ PF≥0.9
- ▶ CRI≥80
- ▶ SAA
- ▶ RoHS
- ▶ CE

Code	Watt	Size(AxBmm)	Cut-out(mm)	Lumen(±5%)	N.W/pc(kgs)	Q'ty/CTN
DL41-3-8W-S1	8W	Ø115x70	Ø90-95	690lm	0.20	30PCS
DL41-3-10W-S1	10W	Ø115x70	Ø90-95	830lm	0.20	30PCS

DL41D Downlight

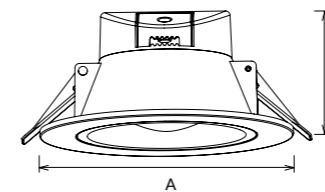

DL41D LED downlight with SMD LED, high light transmittance lens, plastic coated aluminum heat sink, internal driver. IP54 waterproof for cover. CCT switchable by slide switch is available.

- ▶ 60°
- ▶ IP40
IP54
- ▶ DIM
- ▶ Flicker Free
- ▶ SLIDE SWITCH 3 in 1
- ▶ AC 200-240V
- ▶ PF≥0.9
- ▶ CRI≥80
- ▶ SAA
- ▶ RoHS
- ▶ CE

Code	Watt	Size(AxBmm)	Cut-out(mm)	Lumen(±5%)	N.W/pc(kgs)	Q'ty/CTN
DL41D-3-10W-D	10W	Ø115x58	Ø90-95	900lm	0.20	30PCS
DL41D-3-10W-P3	10W	Ø115x61	Ø90-95	980lm	0.20	30PCS





DL334A



DL334B



DL256A



DL256B

DL334 Downlight

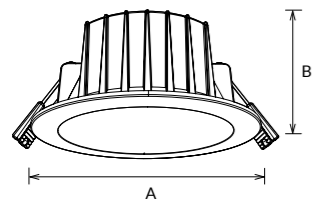

DL334A/B SMD LED Down light adopts high lumen SMD LED, PC diffuser with even light output. Plastic coated aluminum heat sink with internal driver design; it is our most economical and practical downlight version. Dimmable driver shares great popularity by the excellent dimming effect.

- ▶ 100° IP20 / IP54
- ▶ DIM Flicker Free SLIDE SWITCH 3 in 1
- ▶ AC 200-240V PF ≥ 0.9 CRI ≥ 80
- ▶ SAA RoHS CE

Code	Watt	Size(AxBmm)	Cut-out(mm)	Lumen(±5%)	N.W/pc(kgs)	Q'ty/CTN
DL334A-3-8W-D	8W	Ø106x48	Ø90-95	720lm	0.18	45PCS
DL334A-3-8W-P3	8W	Ø106x48	Ø90-95	800lm	0.18	45PCS
DL334B-3-8W-D	8W	Ø106x44.5	Ø90-95	720lm	0.16	45PCS
DL334B-3-8W-P3	8W	Ø106x44.5	Ø90-95	800lm	0.16	45PCS

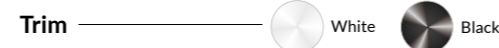

DL256 Downlight

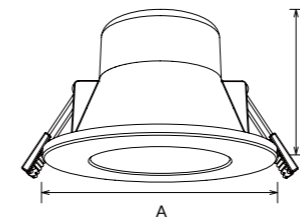

DL256 compact downlight adopts high efficiency SMD LED chips, opal PC diffuser and plastic covered aluminium housing. Front CCT adjustable switch, with exchangeable bezels magnetic onto main body. Internal dimmable driver is compatible with most dimmers in the market with smooth dimming performance.

- ▶ 100° IP20 / IP54 IP40 / IP54
- ▶ DIM Flicker Free SLIDE SWITCH 3 in 1
- ▶ AC 200-240V PF ≥ 0.9 CRI ≥ 80
- ▶ SAA RoHS CE

Code	Watt	Size(AxBmm)	Cut-out(mm)	Lumen(±5%)	N.W/pc(kgs)	Q'ty/CTN
DL256A-3-8W -P3	8W	Ø110x67.5	Ø90-95mm	800lm	0.15	36PCS
DL256B-3-8W -P3	8W	Ø110x67.5	Ø90-95mm	800lm	0.17	36PCS

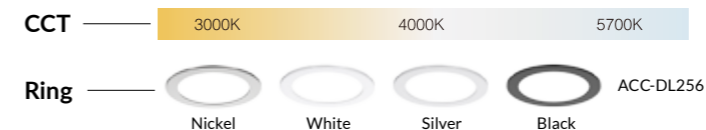



DL260 Downlight

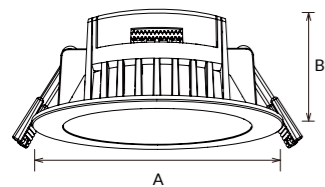

DL260 slimline downlight adopts high efficiency SMD LED chips, opal PC diffuser and plastic covered aluminium housing. Flat surface design integrates well into ceiling. Internal dimmable driver is compatible with most dimmers in the market with smooth dimming performance.

- 110°
- IP40
IP54
- DIM
- Flicker Free
- SLIDE SWITCH 0-10V
- WIFI
- Bluetooth
- Smart Lighting
- AC 200-240V
- PF≥0.9
- CRI≥80
- SAA
- RoHS
- CE

Code	Watt	Size(AxBmm)	Cut-out(mm)	Lumen(±5%)	N.W/pc(kgs)	Q'ty/CTN
DL260A-3-8W	8W	Ø106x40	Ø90-95	800lm	0.15	45PCS
DL260B-3-8W	8W	Ø106x40	Ø90-95	800lm	0.19	45PCS



DL261 Downlight

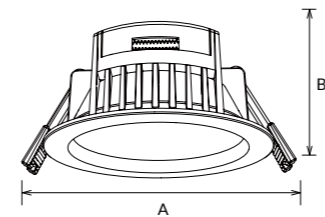

DL261 slimline downlight adopts high efficiency SMD LED chips, opal PC diffuser and plastic covered aluminium housing. Stepped surface design reduces glare rate effectively. Internal dimmable driver is compatible with most dimmers in the market with smooth dimming performance.

- 90°
- IP20
IP54
- IP40
IP54
- DIM
- Flicker Free
- SLIDE SWITCH 0-10V
- WIFI
- Bluetooth
- Smart Lighting
- AC 200-240V
- PF≥0.9
- CRI≥80
- SAA
- RoHS
- CE

Code	Watt	Size(AxBmm)	Cut-out(mm)	Lumen(±5%)	N.W/pc(kgs)	Q'ty/CTN
DL261A-3-8W	8W	Ø106x47	Ø90-95	800lm	0.16	45PCS
DL261B-3-8W	8W	Ø106x47	Ø90-95	800lm	0.20	45PCS





DL192 Downlight

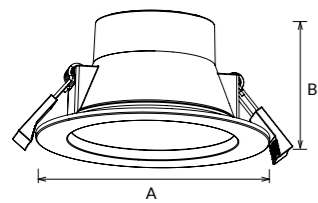

DL192 compact downlight adopts high efficiency SMD LED chips, opal PC diffuser and plastic covered aluminium housing. Stepped surface design reduces glare rate effectively. Internal dimmable driver is compatible with most dimmers in the market with smooth dimming performance.

- ▶ 90° IP40
IP54
- ▶ DIM Flicker Free SLIDE SWITCH 3 in 1
- ▶ AC 200-240V PF≥0.9 CRI≥80
- ▶ SAA RoHS CE

Code	Watt	Size(AxBmm)	Cut-out(mm)	Lumen(±5%)	N.W/pc(kgs)	Q'ty/CTN
DL192-3-10W-D	10W	Ø115x60	Ø90-95	870lm	0.18	30PCS
DL192-3-10W-P3	10W	Ø115x62.6	Ø90-95	1000lm	0.18	30PCS

DL174 Downlight

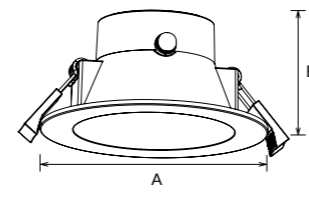

DL174 compact downlight adopts high efficiency SMD LED chips, opal PC diffuser and plastic covered aluminium housing. Flat surface design integrates well into ceiling. Internal dimmable driver is compatible with most dimmers in the market with smooth dimming performance.

- ▶ 90° IP40
IP54
- ▶ DIM Flicker Free SLIDE SWITCH 3 in 1
- ▶ AC 200-240V PF≥0.9 CRI≥80
- ▶ SAA RoHS CE

Code	Watt	Size(AxBmm)	Cut-out(mm)	Lumen(±5%)	N.W/pc(kgs)	Q'ty/CTN
DL174-2.5-7W-D	7W	Ø85x57	Ø68-75	630lm	0.14	50PCS
DL174-2.5-7W-P3	7W	Ø85x59.6	Ø68-75	720lm	0.14	50PCS
DL174-3-10W-D	10W	Ø115x57	Ø90-95	870lm	0.18	30PCS
DL174-3-10W-P3	10W	Ø115x59.6	Ø90-95	1000lm	0.18	30PCS



DL270 Downlight

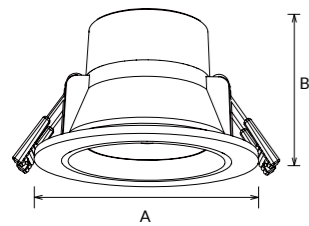

DL270 LED downlight is low UGR design with internal driver, adopting high lumen SMD which could reach 105lm/W, special lens with uniform and soft lighting, quick terminal makes installation easier. The plastic coated aluminum improves the stability and safety. Interchangeable CCT with slide switch is available.

- ▶ 45° 60° IP20 IP40
- ▶ DIM Flicker Free SLIDE SWITCH 3 in 1
- ▶ AC 220-240V PF ≥ 0.9 CRI ≥ 80
- ▶ SAA RoHS CE

Code	Watt	Size(AxBmm)	Cut-out(mm)	Lumen(±5%)	N.W/pc(kgs)	Q'ty/CTN
DL270-2.5-5W-D	5W	Ø85x55	Ø68-75mm	530lm	0.15	50PCS
DL270-2.5-5W-P3	5W	Ø85x57.5	Ø68-75mm	530lm	0.19	50PCS

CCT — 3000K 4000K 5000K 5700K

Trim — White



CL360 Downlight

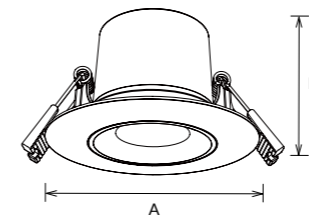

CL360 is a dimmable mini recessed SMD downlight which is fixed or adjustable. 6 bits quick connector help install conveniently. 3CCT interchangeable is available.

- ▶ 36° 60° 25° IP20 IP54
- ▶ Flicker Free SLIDE SWITCH 3 in 1
- ▶ AC 220-240V PF ≥ 0.9 CRI ≥ 80
- ▶ SAA RoHS CE

Code	Watt	Size(AxBmm)	Cut-out(mm)	Lumen(±5%)	N.W/pc(kgs)	Q'ty/CTN
CL360-2.5-5W-D	5W	Ø85x50	Ø68	500lm	0.11	50PCS
CL360-3-8W-D	8W	Ø105x50	Ø90	800lm	0.17	50PCS

CCT — 3000K 4000K 5000K 5700K

Trim — White Black

Fire Testing



I-Joists

Timber Engineered I-Joists, sometimes known as I-Beams, are comprised of a top and bottom timber flange combined with a tall vertical OSB (Oriented Strand Board).



Solid Timber Joists

Softwood joists are ideal for smaller projects, such as extensions, small dwellings or where relatively short spans are involved.



Joist Compliant

Fire Rated Downlights



LED Downlight
COB Series



DL333A



DL333B



DL333C



DL333 Fire rated downlight

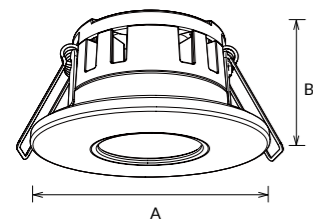

DL333 is a group design fireproof structured led downlight. Type A slim body(IP65 for room side), Type B deep design with anti-glare effect(IP65 for room side), Type C Gyro 360degree(IP54 for room side). It adopts high lumen SMD light source and optic lens with uniform light output. Four replaceable cover by magnetic design options: white, black, silver and nickel brushed.

- 30°
 - 36°
 - 60°
 - 360°
 - 25°
- IP20 IP65
 - IP20 IP54
 - UGR<19
 - 30 FIRE
 - 60 FIRE
 - 90 FIRE
- DIM
 - Flicker Free
 - SLIDE SWITCH 3 in 1
- AC 200-240V
 - PF≥0.9
 - CRI≥80
- SAA
 - RoHS
 - CE

Code	Watt	Size(AxBmm)	Cut-out(mm)	Lumen(±5%)	N.W/pc(kgs)	Q'ty/CTN
DL333A-2.5-6W	6W	Ø85x48	Ø68-75	550lm	0.27	36PCS
DL333B-2.5-6W (White)	6W	Ø85x68	Ø68-75	420lm	0.29	36PCS
DL333B-2.5-6W(Black)	6W	Ø85x68	Ø68-75	360lm	0.29	36PCS
DL333C-2.5-6W	6W	Ø95x73	Ø78-85	550lm	0.27	36PCS

CCT — 2700K 3000K 4000K 5000K

Trim — White Black

Ring — Nickel White Silver Black

DL354 Fire rated downlight

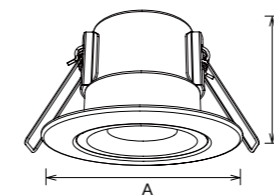

DL354 is IP65 fireproof SMD downlight. It is designed for convenient installation with external quick junction box. It is available to be directly covered with insulation material. 3CCT and triac dimming is available.

- 60°
 - IP40 IP65
 - 30 FIRE
 - 60 FIRE
 - 90 FIRE
- DIM
 - Flicker Free
 - SLIDE SWITCH 3 in 1
- AC 220-240V
 - PF≥0.85
 - CRI≥80
- SAA
 - RoHS
 - CE

Code	Watt	Size(AxBmm)	Cut-out(mm)	Lumen(±5%)	N.W/pc(kgs)	Q'ty/CTN
DL354-2.5-5W	5W	Ø85x55	Ø68-Ø75	550lm	0.18	50PCS

CCT — 2700K 3000K 4000K 5000K

Trim — White Black



DL294A



DL294B



DL294C

DL294A/B/C Fire rated downlight

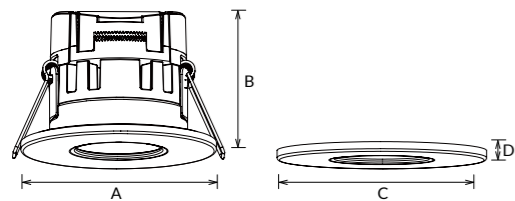

DL294 LED downlight adopts fireproof bracket and aluminium heat sink, which not only meets the fireproof structure demand but also offers a good heat dissipation performance. Four cover options: white, black, silver and nickel brushed. The cover is fixed by magnetic design, and it has a hidden slide switch for CCT, convenient for CCT change and cover change.

- ▶ 30° 36° 60° 360° 25°
- ▶ IP20 IP65 IP20 IP54
- ▶ 30min FIRE 60min FIRE 90min FIRE
- ▶ DIM Flicker Free SLIDE SWITCH 3 in 1
- ▶ AC 220-240V PF ≥ 0.85 CRI ≥ 80
- ▶ SAA RoHS CE

Code	Watt	Size(AxB/CxDmm)	Cut-out(mm)	Lumen(±5%)	N.W/pc(kgs)	Q'ty/CTN
DL294A-2.5-6W	6W	Ø85x60	Ø68-75	650lm	0.20	36PCS
DL294B-2.5-6W	6W	Ø85x80	Ø68-75	550lm (White)/550lm (Black)	0.23	36PCS
DL294C-2.5-6W	6W	Ø95x82	Ø78-85	650lm	0.33	36PCS
DL294A-Cover	/	Ø85x4	/	/	0.02	216PCS
DL294B-Cover	/	Ø85x4	/	/	0.02	216PCS

CCT — 2700K — 3000K — 4000K — 5000K

Trim — White Black

DL294 SERIES

Fireproof: 30Min/60Min/90Min

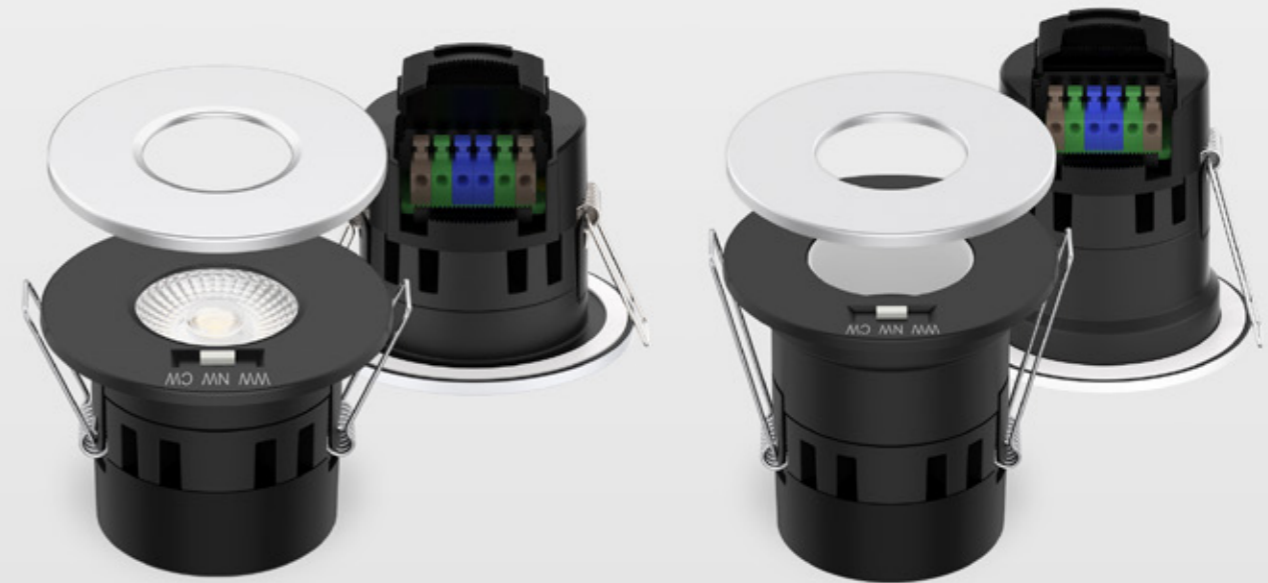

DL294A Replaceable cover



DL294B Replaceable cover



DL294C





DL302 Fire rated downlight

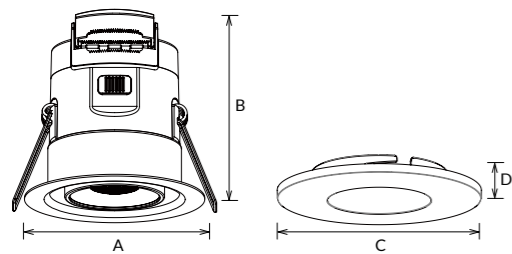

DL302 is IP65 fireproof SMD downlight. White, chrome and nickel brushed cover is replaceable, and interchangeable CCT help to release your stock. Quick connector on back side makes quick installation.

- 70° beam angle
- IP20 / IP65
- 30min FIRE
- 60min FIRE
- 90min FIRE
- DIM
- Flicker Free
- SLIDE SWITCH 3 in 1
- AC 220-240V
- PF≥0.85
- CRI≥80
- SAA
- RoHS
- CE

Code	Watt	Size(AxB/CxDmm)	Cut-out(mm)	Lumen(±5%)	N.W/pc(kgs)	Q'ty/CTN
DL302-5W	5W	Ø85x74	Ø70	600lm	0.17	60PCS
DL302-7W	7W	Ø85x81	Ø70	800lm	0.19	60PCS
DL302-Lamp Cover	/	Ø85x12.5	/	/	0.05	150PCS

CCT — 2700K — 3000K — 4000K — 5000K

Trim — White

Ring — Nickel — White — Silver

CL145 Fire rated downlight

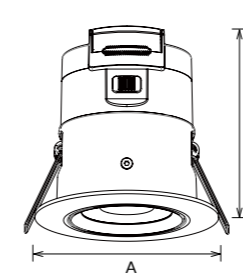

CL145 is fireproof SMD downlight with high lumen efficiency 116lm/W. It is designed with gyro design in all direction 360°. Quick connector on back side makes quick installation. White, chrome and nickel brushed color finishing for frame is achievable.

- 70° beam angle
- 360° beam angle
- 23° beam angle
- IP20 / IP65
- 30min FIRE
- 60min FIRE
- 90min FIRE
- DIM
- Flicker Free
- SLIDE SWITCH 3 in 1
- AC 220-240V
- PF≥0.85
- CRI≥80
- SAA
- RoHS
- CE

Code	Watt	Size(AxBmm)	Cut-out(mm)	Lumen(±5%)	N.W/pc(kgs)	Q'ty/CTN
CL145-7W	7W	Ø95x96	Ø80	830lm	0.35	40PCS

CCT — 2700K — 3000K — 4000K — 5000K

Trim — White — Chrome — Nickel Brushed

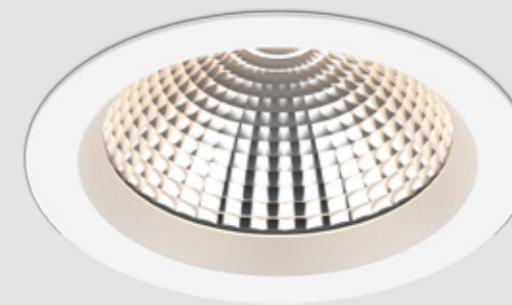
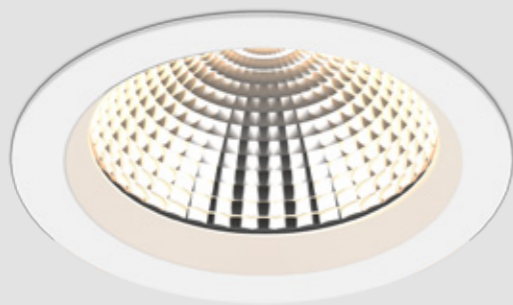

DL229 Downlight

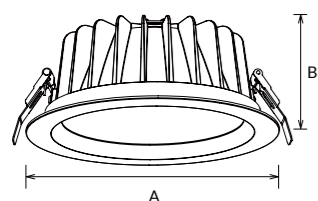

DL229 commercial downlight adopts high power COB LED chip, reflector and tempered glass, ADC12 aluminum heatsink. External driver is exchangeable through quick connector among non-dimmable driver, Triac dimmable, 0-10V and DALI dimmable drivers.

- Beam angles: 24°, 45°, 60°
- IP20, IP54
- Dimming: DIM, DALI, 0-10V, Flicker Free, SLIDE SWITCH 3 in 1
- AC 200-240V, PF≥0.9, CRI≥80, CRI≥90, CRI≥97, SDCM <6
- Compliance: SAA, RoHS, CE

Code	Watt	Size(AxBmm)	Cut-out(mm)	Lumen(±5%)	N.W/pc(kgs)	Q'ty/CTN
DL229-3-10W	10W	Ø110x53	Ø90-95	988lm	0.25	30PCS
DL229-3-10W	10W	Ø110x53	Ø90-95	1250lm	0.33	30PCS
DL229-3-12W	12W	Ø110x53	Ø90-95	1312lm	0.25	30PCS
DL229-4-12W	12W	Ø145x65	Ø120-130	1485lm	0.41	20PCS
DL229-4-18W	18W	Ø145x65	Ø120-130	1997lm	0.41	20PCS
DL229-4-18W	18W	Ø145x65	Ø120-130	2300lm	0.50	20PCS
DL229-4-25W	25W	Ø145x65	Ø120-130	2733lm	0.41	20PCS
DL229-6-18W	18W	Ø190x75	Ø160-170	2079lm	0.69	12PCS
DL229-6-25W	25W	Ø190x75	Ø160-170	2798lm	0.69	12PCS
DL229-6-25W	25W	Ø190x75	Ø160-170	3200lm	0.77	12PCS
DL229-6-33W	33W	Ø190x75	Ø160-170	3674lm	0.69	12PCS
DL229-8-18W	18W	Ø225x87	Ø200-210	2066lm	0.96	12PCS
DL229-8-25W	25W	Ø225x87	Ø200-210	2801lm	0.96	12PCS
DL229-8-30W	30W	Ø225x87	Ø200-210	4000lm	1.08	12PCS
DL229-8-33W	33W	Ø225x87	Ø200-210	3659lm	0.96	12PCS
DL229-8-42W	42W	Ø225x87	Ø200-210	4823lm	0.96	12PCS

CCT: 2700K, 3000K, 4000K, 5000K | Trim: White, Black

DL22 Downlight

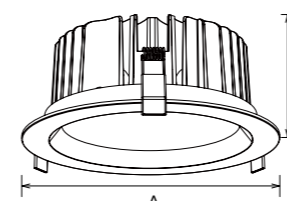

DL22 the most classic commercial downlight adopts brand CITIZEN and Bridgelux COB, reflector and tempered glass, ADC12 aluminum heatsink and bezel. The sophisticated ADC12 heatsink design is unique and serves the purpose of superb heat dissipation. External driver is exchangeable through quick connector among non-dimmable driver, Triac dimmable, 0-10V and DALI dimmable drivers. Tunable White option adopts dual color temperature COB and dual DALI driver, supports the concept of Human Centric Lighting (HCL), widely applicable in health care center, nursing home, school etc.

- Beam angles: 24°, 36°, 45°, 60°
- IP20, IP54
- Dimming: DIM, DALI, 0-10V, Flicker Free, TUNABLE WHITE, SLIDE SWITCH 3 in 1
- AC 100-240V, AC 200-240V, PF≥0.9, CRI≥80, CRI≥90, CRI≥97
- Compliance: SAA, RoHS, CE

Code	Watt	Size(AxBmm)	Cut-out(mm)	Lumen(±5%)	N.W/pc(kgs)	Q'ty/CTN
DL22-3-10W	10W	Ø110x53	Ø90-100	800lm	0.35	30PCS
DL22-3-10W	10W	Ø110x53	Ø90-95	1250lm	0.35	30PCS
DL22-3-13W	13W	Ø110x53	Ø90-100	1100lm	0.35	30PCS
DL22-4-18W	18W	Ø145x65	Ø120-130	2105lm	0.85	20PCS
DL22-4-18W	18W	Ø145x65	Ø120-130	2300lm	0.81	20PCS
DL22-4-25W	25W	Ø145x65	Ø120-130	2750lm	0.85	20PCS
DL22-6-18W	18W	Ø190x75	Ø160-170	2160lm	1.04	12PCS
DL22-6-25W	25W	Ø190x75	Ø160-170	2875lm	1.04	12PCS
DL22-6-25W	25W	Ø190x75	Ø160-170	3200lm	1.04	12PCS
DL22-6-35W	35W	Ø190x75	Ø160-170	3955lm	1.08	12PCS
DL22-6-45W	45W	Ø190x75	Ø160-170	4770lm	1.08	12PCS
DL22-8-30W	30W	Ø225x87	Ø200-210	4000lm	1.48	12PCS
DL22-8-18W	18W	Ø225x87	Ø200-210	2160lm	1.48	12PCS
DL22-8-25W	25W	Ø225x87	Ø200-210	2875lm	1.48	12PCS
DL22-8-35W	35W	Ø225x87	Ø200-210	3955lm	1.48	12PCS
DL22-8-45W	45W	Ø225x87	Ø200-210	4770lm	1.48	12PCS

CCT: 2700K, 3000K, 4000K, 5000K | Trim: White, Black, Silver



DL288 Downlight

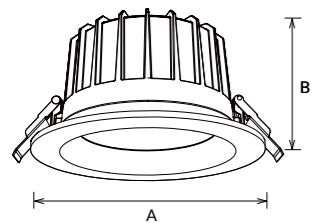

DL288 LED downlight is unique designed with reflector and COB high power LED chip. ADC12 aluminum housing provides excellent thermal dissipation. LED module design could save SKU and offer an easy module replacement. Dimmable flicker free driver shares great popularity by the excellent dimming effect. IP54 waterproof for front part.

- ▶ 60° IP40
IP54
- ▶ DIM DALI 0-10V Flicker Free
- ▶ AC 220-240V PF≥0.9 CRI≥80 CRI≥90
- ▶ SAA RoHS CE

Code	Watt	Size(AxBmm)	Cut-out(mm)	Lumen(±5%)	N.W/pc(kgs)	Q'ty/CTN
DL288-2.5-10W	10W	Ø90x60	75-83	1180lm	0.25	36PCS
DL288-6-18W	18W	Ø172x96	150-160	2290lm	0.78	12PCS
DL288-6-25W	25W	Ø172x96	150-160	3070lm	0.78	12PCS
DL288-8-25W	25W	Ø228x125	195-210	3070lm	1.26	12PCS
DL288-8-30W	30W	Ø228x125	195-210	3600lm	1.26	12PCS

CCT ——— 2700K 3000K 4000K 5000K

Trim ——— White Black

Conversion ring ———



ADC12 Aluminum housing

ACC-DL288

- 2700K/3000K/4000K/5000K optional
- CRI80/90/97 optional
- Different lighting efficiency level optional

IP54

LIGHT SOURCE INTERCHANGEABLE



DL326 Downlight

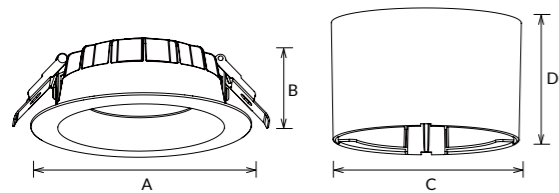

DL326 is a super slim COB downlight, ADC12 die-cast housing and tempered glass is corrosion resistance. it's not only a recessed downlight, it can be surface mounted with extra accessory, 4", 6", 8" surface mounted installation available.

- ▶
- ▶
- ▶
- ▶



Code	Watt	Size(AxB/CxDmm)	Cut-out(mm)	Lumen(±5%)	N.W/pc(kgs)	Q'ty/CTN
DL326-2.5-6W	6W	Ø85x36	Ø68-75	620lm	0.19	36PCS
DL326-3-10W	10W	Ø110x45	Ø90-95	1000lm	0.26	36PCS
DL326-3-13W	13W	Ø110x45	Ø90-95	1330lm	0.26	36PCS
DL326-4-13W	13W	Ø145x52	Ø120-130	1380lm	0.39	30PCS
DL326-4-18W	18W	Ø145x52	Ø120-130	1990lm	0.39	30PCS
DL326-6-18W	18W	Ø190x52	Ø160-170	2290lm	0.58	20PCS
DL326-6-25W	25W	Ø190x52	Ø160-170	3080lm	0.58	20PCS
DL326-8-18W	18W	Ø228x59	Ø200-210	2160lm	0.78	12PCS
DL326-8-25W	25W	Ø228x59	Ø200-210	2990lm	0.78	12PCS
DL326-8-35W	35W	Ø228x59	Ø200-210	3860lm	0.78	12PCS
4" accessory	/	Ø148x93	/	/	0.34	24PCS
6" accessory	/	Ø193x93	/	/	0.43	12PCS
8" accessory	/	Ø232x93	/	/	0.53	12PCS

CCT ——— 2700K — 3000K — 4000K — 5000K

Trim ——— White Black

Conversion ring ——— ACC-DL326-4-WT ACC-DL326-6-WT ACC-DL326-8-WT

RECESSED TO SURFACE MOUNTED

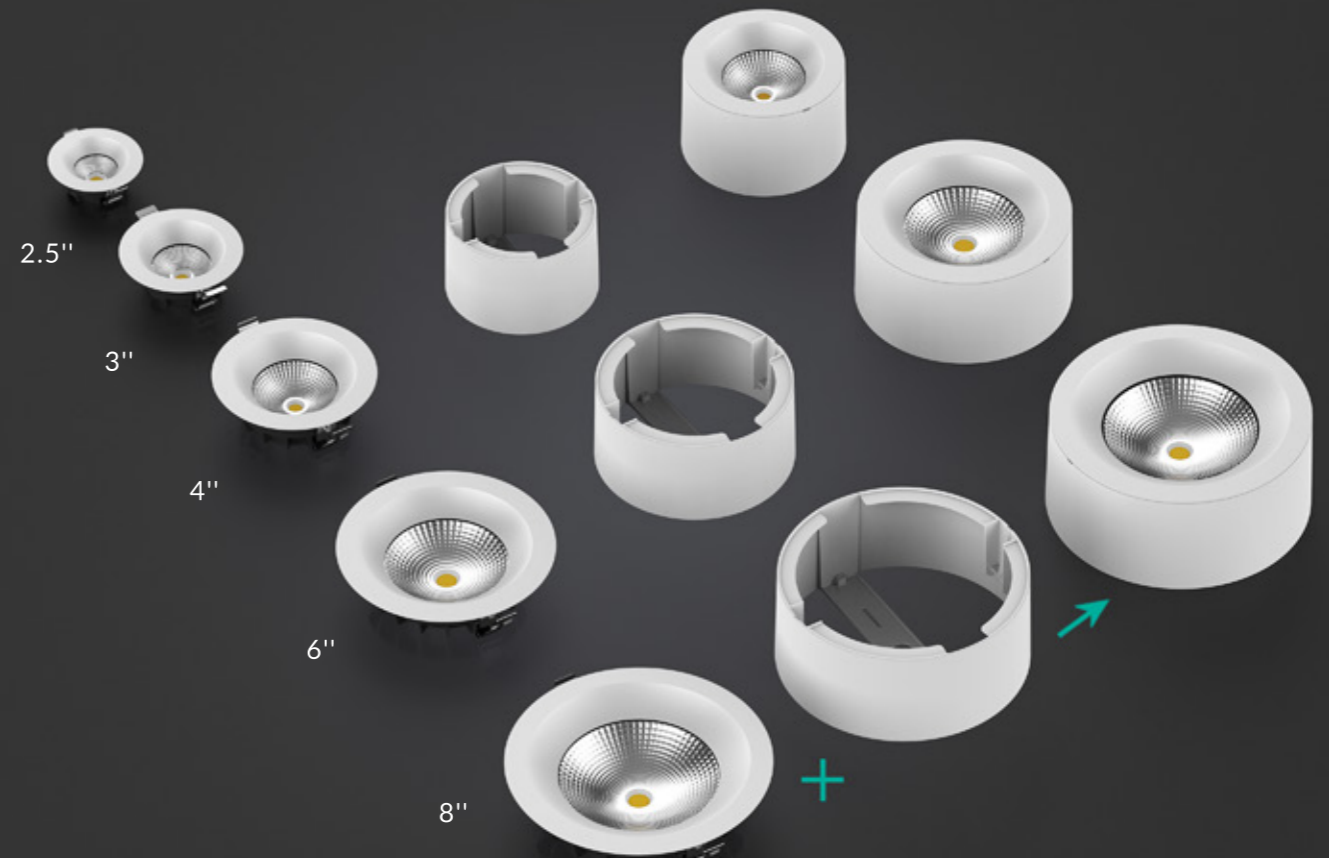
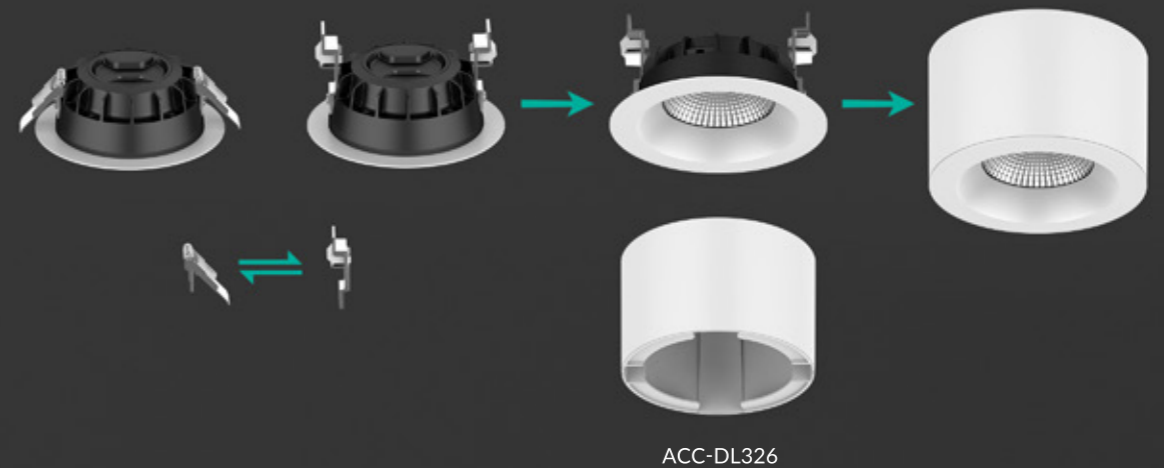

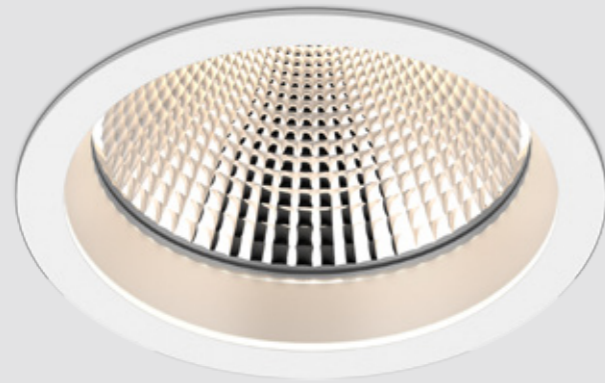

DL113 Downlight

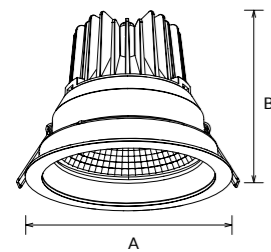

DL113 unique downlight adopts brand CITIZEN COB, reflector and tempered glass, ADC12 aluminum heatsink. Deep reflector reduces glare rate effectively. External driver is exchangeable through quick connector among non-dimmable driver, Triac dimmable, 0-10V and DALI dimmable drivers.

- ▶ 60°
- ▶ IP20
- ▶ DIM
- ▶ DALI
- ▶ 0-10V
- ▶ Flicker Free
- ▶ AC 200-240V
- ▶ PF ≥ 0.9
- ▶ CRI ≥ 80
- ▶ CRI ≥ 90
- ▶ CRI ≥ 97
- ▶ SAA
- ▶ RoHS
- ▶ CE

Code	Watt	Size(AxBmm)	Cut-out(mm)	Lumen(±5%)	N.W/pc(kgs)	Q'ty/CTN
DL113-4-13W	13W	Ø150x123	Ø135-140	1520lm	0.85	12PCS
DL113-4-20W	20W	Ø150x123	Ø135-140	2280lm	0.85	12PCS
DL113-4-25W	25W	Ø150x123	Ø135-140	2810lm	0.85	12PCS

CCT 2700K 3000K 4000K 5000K

Trim White Black Silver

CL156 Downlight

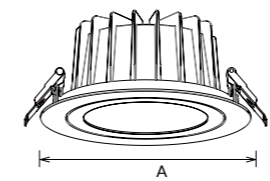

CL156 is IP54 LED downlight with COB LED. Various optical design 10°/15°/20°/24°/36°/60° and full dimensions 2.5inch, 3inch, 4inch, 6inch meet different demand.

- ▶ 10°
- ▶ 15°
- ▶ 24°
- ▶ 36°
- ▶ 45°
- ▶ 60°
- ▶ IP20
- ▶ DIM
- ▶ DALI
- ▶ 0-10V
- ▶ Flicker Free
- ▶ AC 220-240V
- ▶ PF ≥ 0.9
- ▶ CRI ≥ 80
- ▶ CRI ≥ 90
- ▶ SAA
- ▶ RoHS
- ▶ CE



Code	Watt	Size(AxBmm)	Cut-out(mm)	Lumen(±5%)	N.W/pc(kgs)	Q'ty/CTN
CL156-2.5-8W	8W	Ø80x32	Ø68-75	850lm	0.24	30PCS
CL156-3-10W	10W	Ø110x47	Ø90-95	1100lm	0.38	30PCS
CL156-3-13W	13W	Ø110x47	Ø90-95	1400lm	0.38	30PCS
CL156-4-18W	18W	Ø140x65	Ø120-130	2200lm	0.56	12PCS
CL156-4-25W	25W	Ø140x65	Ø120-130	2800lm	0.56	12PCS
CL156-6-18W	18W	Ø180x81	Ø160-170	2250lm	0.88	12PCS
CL156-6-25W	25W	Ø180x81	Ø160-170	2800lm	0.88	12PCS
CL156-6-35W	35W	Ø180x81	Ø160-170	3700lm	0.88	12PCS

CCT 2700K 3000K 4000K 5000K

Trim White Black

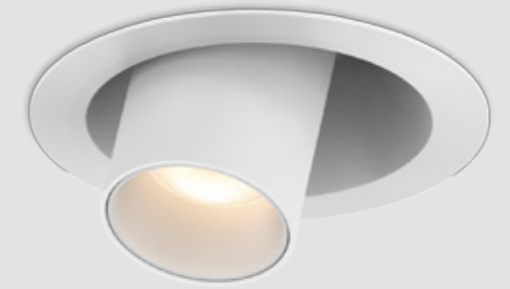
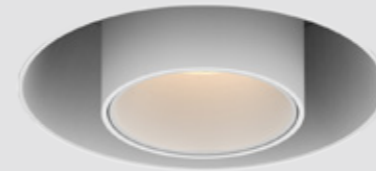

DL122 Downlight

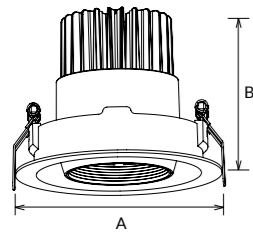

DL122 Gimbal downlight adopts brand CITIZEN COB, exchangeable reflector and tempered glass, ADC12 aluminum heatsink. Horizontally 355° and vertically 30° rotatable. External driver is exchangeable through quick connector among non-dimmable driver, Triac dimmable, 0-10V and DALI dimmable drivers.

- ▶ 24° 45° 60°
- ▶ 355° 30°
- ▶ IP20
- ▶ DIM DALI 0-10V Flicker Free
- ▶ AC 200-240V PF≥0.9 CRI≥80 CRI≥90 CRI≥97
- ▶ SAA RoHS CE

Code	Watt	Size(AxBmm)	Cut-out(mm)	Lumen(±5%)	N.W/pc(kgs)	Q'ty/CTN
DL122-4-18W	18W	Ø150x116	Ø130-140	1820lm	0.71	12PCS
DL122-4-25W	25W	Ø150x116	Ø130-140	2430lm	0.71	12PCS
DL122-6-25W	25W	Ø185x130	Ø160-170	2420lm	1.10	12PCS
DL122-6-35W	35W	Ø185x130	Ø160-170	3260lm	1.10	12PCS
DL122-6-42W	42W	Ø185x130	Ø160-170	3780lm	1.10	12PCS

CCT — 2700K 3000K 4000K 5000K

Trim — White Black

DL369 Downlight

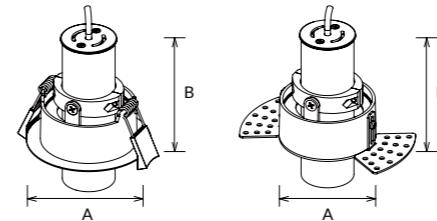

DL369 an extension design downlight with external driver, DL369A as reflector+Trim version, DL369B as reflector+Trimless, DL369C as lens+Trim, DL369D as lens+trimless, . Adopt high lumen brand COB light source. The lamp body can be pulled out and do 350 degree horizontal rotation and 20 degree vertically rotation to meet more application lighting demand. Deep recessed module can lower the glare and offer a comfortable visual experience, 3CCT adjustable via an integrated dip switch to save your stock SKU.

- ▶ 20° 24° 30° 36° 45°
- ▶ 350° 20°
- ▶ IP20
- ▶ DIM Flicker Free SLIDE SWITCH 3 in 1
- ▶ AC 200-240V PF≥0.8 PF≥0.9 CRI≥80 CRI≥90
- ▶ SAA RoHS CE

Code	Watt	Size(AxBmm)	Cut-out(mm)	Lumen(±5%)	N.W/pc(kgs)	Q'ty/CTN
DL369A-2.5-6W	6W	Ø85xH111.5	Ø68-80	600lm	0.25	24PCS
DL369A-3-10W	10W	Ø100xH131.5	Ø82-95	1000lm	0.37	24PCS
DL369A-3-12W	12W	Ø100xH131.5	Ø82-95	1250lm	0.37	24PCS
DL369B-2.5-6W	6W	Ø66xH111.5	Ø70	600lm	0.26	24PCS
DL369B-3-10W	10W	Ø81xH131.5	Ø85	1000lm	0.39	24PCS
DL369B-3-12W	12W	Ø81xH131.5	Ø85	1250lm	0.39	24PCS
DL369C-2.5-6W	6W	Ø85xH111.5	Ø68-80	620lm	0.25	24PCS
DL369C-3-10W	10W	Ø100xH131.5	Ø82-95	1200lm	0.37	24PCS
DL369C-3-12W	12W	Ø100xH131.5	Ø82-95	1450lm	0.37	24PCS
DL369D-2.5-6W	6W	Ø66xH111.5	Ø70	620lm	0.26	24PCS
DL369D-3-10W	10W	Ø81xH131.5	Ø85	1200lm	0.39	24PCS
DL369D-3-12W	12W	Ø81xH131.5	Ø85	1450lm	0.39	24PCS

CCT — 2700K 3000K 4000K 5000K

Trim — White Black

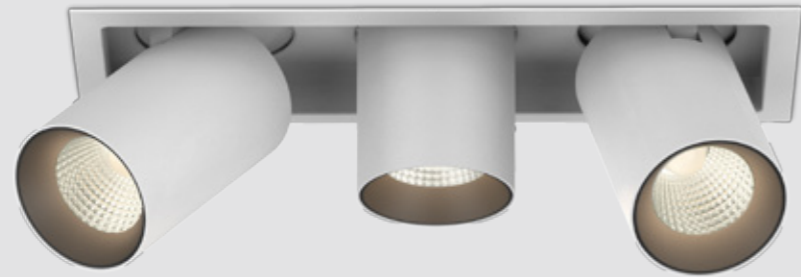

DL297A Downlight

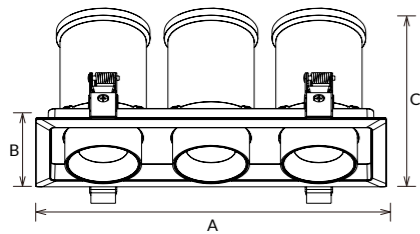

DL297A LED downlight adopts high lumen COB light source, the special optic lens and reflector design offer a uniform light output and low glare effect. It is an extension design, 360 degree horizontal rotation and 68 degree vertically rotation. And it has round shape, square shape with single/ double/triple heads which is suitable for various application area.

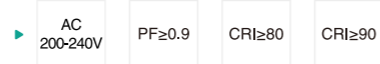
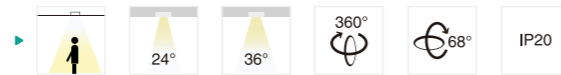

Code	Watt	Size(AxBxCmm)	Cut-out(mm)	Lumen(±5%)	N.W/pc(kgs)	Q'ty/CTN
DL297A-2.5-10W/15W	10W/15W	Ø100x114	Ø83-90	900lm/1350lm	0.50	24PCS
DL297A-1010-10W/15W	10W/15W	100x100x114	83-90x83-90	900lm/1350lm	0.50	24PCS
DL297A-1018-20W/30W	20W/30W	180x100x114	85-90x165-170	1800lm/2700lm	0.90	12PCS
DL297A-1026-30W/42W/45W	30W/42W/45W	260x100x114	85-90x245-250	2700lm/4050lm /3600lm	1.50	6PCS

CCT ——— 2700K 3000K 4000K 5000K

Trim ——— White Black



LED Downlight
COB Series

DL297 SERIES

DL297A Series Extension Design
Adjustable Downlight

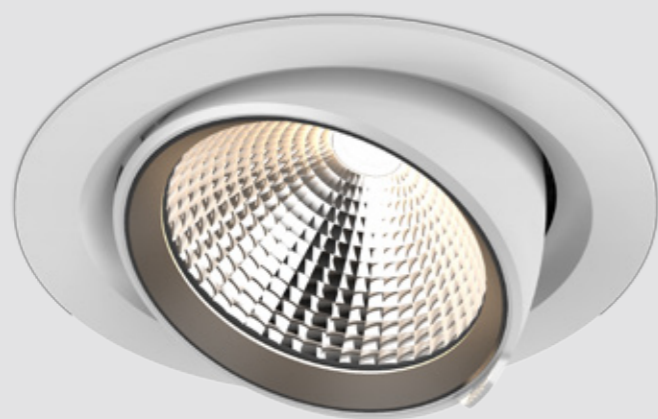

DL77 Downlight

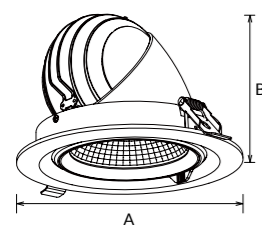

DL77 Gimbal downlight adopts brand CITIZEN COB, reflector and tempered glass, ADC12 aluminum heatsink. External driver is exchangeable through quick connector among non-dimmable driver, Triac dimmable, 0-10V and DALI dimmable drivers.

- Beam angles: 15°, 24°, 36°, 45°, 60°, 350°
- Rotation: 350°, 35°
- IP Rating: IP20
- Dimming: DIM, DALI, 0-10V, Flicker Free
- AC: AC 200-240V, PF≥0.9, CRI≥80, CRI≥90, CRI≥97
- Certifications: SAA, RoHS, CE, CB

Code	Watt	Size(AxBmm)	Cut-out(mm)	Lumen(±5%)	N.W/pc(kgs)	Q'ty/CTN
DL77-2.5-10W	10W	Ø96x68	Ø85-90	800lm	0.25	36PCS
DL77-4-15W	15W	Ø145x102	Ø120-130	1800lm	0.57	18PCS
DL77-4-20W	20W	Ø145x102	Ø120-130	2100lm	0.57	18PCS
DL77-6-35W	35W	Ø180x128.5	Ø165-170	3800lm	1.07	12PCS
DL77-6-45W	45W	Ø180x128.5	Ø165-170	5080lm	1.07	12PCS

CCT: 2700K, 3000K, 4000K, 5000K
 Trim: White, Black, Silver

DL335 Downlight

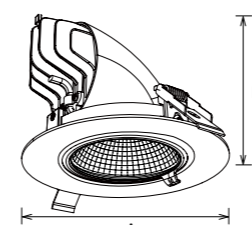

DL335 is scoop design COB downlight and can be rotated in horizontal direction with 350° and vertical direction 90°. High quality ADC12 die-casting aluminium profile provides excellent thermal dissipation.

- Beam angles: 15°, 24°, 36°, 60°, 350°
- Rotation: 90°, 350°
- IP Rating: IP20
- Dimming: DIM, DALI, 0-10V, Flicker Free
- AC: AC 220-240V, PF≥0.9, CRI≥80, CRI≥90, CRI≥97
- Certifications: SAA, RoHS, CE, CB

Code	Watt	Size(AxBmm)	Cut-out(mm)	Lumen(±5%)	N.W/pc(kgs)	Q'ty/CTN
DL335-2.5-10W	10W	Ø96x74	Ø85-90	1000lm	0.20	36PCS
DL335-4-18W	18W	Ø145x111	Ø125-130	1900lm	0.60	18PCS
DL335-4-25W	25W	Ø145x111	Ø125-130	2600lm	0.60	18PCS
DL335-6-25W	25W	Ø180x147	Ø165-170	2700lm	1.05	12PCS
DL335-6-35W	35W	Ø180x147	Ø165-170	3600lm	1.05	12PCS
DL335-6-45W	45W	Ø180x147	Ø165-170	4500lm	1.05	12PCS
DL335-8-25W	25W	Ø235x144	Ø200-210	2700lm	1.15	12PCS
DL335-8-35W	35W	Ø235x144	Ø200-210	3600lm	1.15	12PCS
DL335-8-45W	45W	Ø235x144	Ø200-210	4500lm	1.15	12PCS

CCT: 2700K, 3000K, 4000K, 5000K
 Trim: White, Black



DL31 Downlight

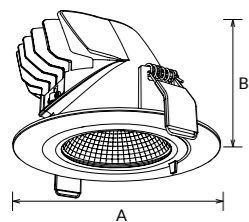

DL31 Gimbal downlight adopts brand CITIZEN COB, reflector and tempered glass, ADC12 aluminum heatsink. External driver is exchangeable through quick connector among non-dimmable driver, Triac dimmable, 0-10V and DALI dimmable drivers.

- ▶ 24° 45° 60° 45° IP20
- ▶ DIM DALI 0-10V Flicker Free
- ▶ AC 100-240V AC 200-240V PF ≥ 0.9 CRI ≥ 80 CRI ≥ 90 CRI ≥ 97
- ▶ SAA RoHS CE

Code	Watt	Size(AxBmm)	Cut-out(mm)	Lumen(±5%)	N.W/pc(kgs)	Q'ty/CTN
DL31-2.5-13W	13W	Ø96x67	Ø85-88	945lm	0.39	24PCS
DL31-6-18W	18W	Ø180x100	Ø160-170	1530lm	1.41	12PCS
DL31-6-25W	25W	Ø180x100	Ø160-170	2550lm	1.41	12PCS
DL31-6-35W	35W	Ø180x100	Ø160-170	3550lm	1.41	12PCS

CCT 2700K 3000K 4000K 5000K

Trim White Black Silver Chrome

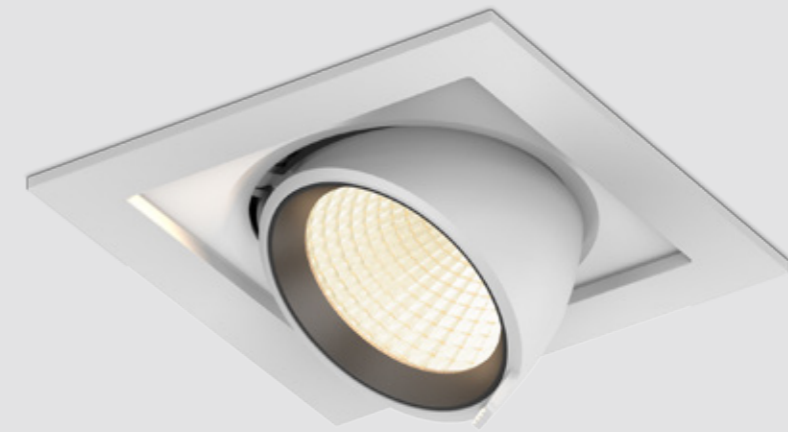

CL108 Downlight

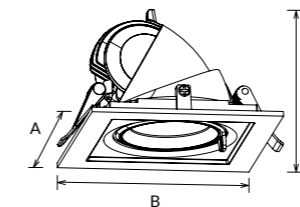

CL108 Gimbal downlight adopts brand CITIZEN COB, reflector and tempered glass, ADC12 aluminum heatsink. Square modular design allows various DIY combinations through splicing plates. External driver is exchangeable through quick connector among non-dimmable driver, Triac dimmable, 0-10V and DALI dimmable drivers.

- ▶ 15° 24° 36° 45°
- ▶ 60° 350° 35° IP20
- ▶ DIM DALI 0-10V Flicker Free
- ▶ AC 200-240V PF ≥ 0.9 CRI ≥ 80 CRI ≥ 90 CRI ≥ 97
- ▶ SAA RoHS CE



Code	Watt	Size(AxBxCmm)	Cut-out(mm)	Lumen(±5%)	N.W/pc(kgs)	Q'ty/CTN
CL108-2.5-10W	10W	100x100x70	85-85	780lm	0.29	36PCS
CL108-4-15W	15W	145x145x107	125-125	1290lm	0.60	18PCS
CL108-4-20W	20W	145x145x107	125-125	2100lm	0.60	18PCS
CL108-6-35W	35W	180x180x129	165-165	3800lm	1.07	12PCS
CL108-6-45W	45W	180x180x129	165-165	4350lm	1.07	12PCS

CCT 2700K 3000K 4000K 5000K

Trim White Black

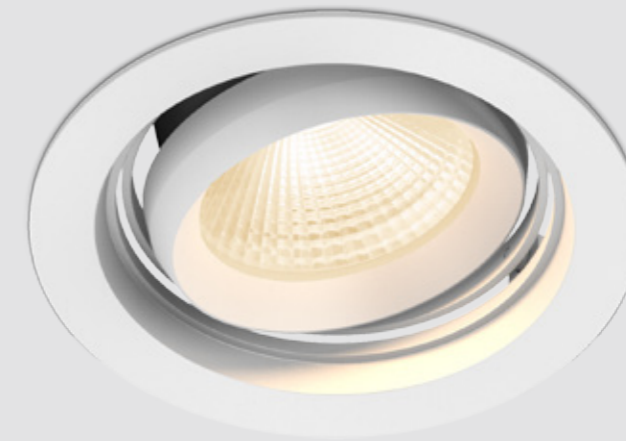
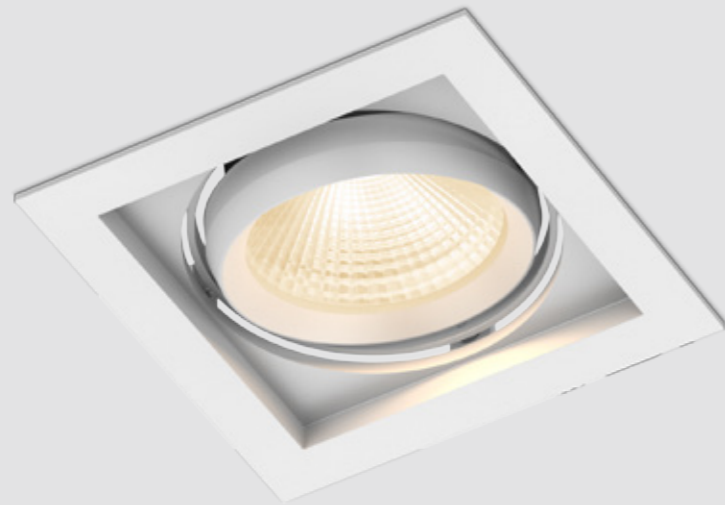

CL113A Downlight

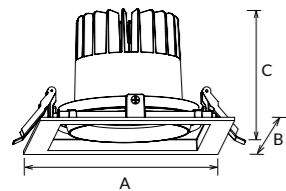

CL113A Gimbal downlight adopts brand CITIZEN COB, reflector and tempered glass, ADC12 aluminum heatsink. Square modular design allows various DIY combinations through splicing plates. External driver is exchangeable through quick connector among non-dimmable driver, Triac dimmable, 0-10V and DALI dimmable drivers.

- ▶
- ▶
- ▶
- ▶



Code	Watt	Size(AxBxCmm)	Cut-out(mm)	Lumen(±5%)	N.W/pc(kgs)	Q'ty/CTN
CL113A-6-25W	25W	175x175x110	150-160	2750lm	0.83	18PCS
CL113A-6-35W	35W	175x175x110	150-160	3850lm	0.83	18PCS

CCT 2700K 3000K 4000K 5000K

Trim White Black

CL113B Downlight

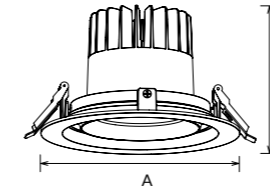

CL113B Gimbal downlight adopts brand CITIZEN COB, reflector and tempered glass, ADC12 aluminum heatsink. External driver is exchangeable through quick connector among non-dimmable driver, Triac dimmable, 0-10V and DALI dimmable drivers.

- ▶
- ▶
- ▶
- ▶

Code	Watt	Size(AxBmm)	Cut-out(mm)	Lumen(±5%)	N.W/pc(kgs)	Q'ty/CTN
CL113B-6-25W	25W	Ø180x110	Ø150-160	2750lm	0.79	18PCS
CL113B-6-35W	35W	Ø180x110	Ø150-160	3850lm	0.79	18PCS

CCT 2700K 3000K 4000K 5000K

Trim White Black



L1

R1

DL170 Downlight

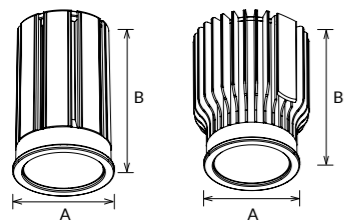

DL170 downlight module adopts brand CITIZEN COB, lens (L) / reflector (R) and AL6063 aluminum heatsink. Various frames are selectable for different applications: round/ square, fixed/ rotatable, symmetric/ asymmetric, flat/ deep, oval hole/ circular hole frame. External driver is exchangeable through quick connector among non-dimmable driver, Triac dimmable, 0-10V and DALI dimmable drivers.

- ▶ 36° 60°
- ▶ IP20
- ▶ DIM DALI 0-10V Flicker Free SLIDE SWITCH
- ▶ AC 220-240V PF≥0.9 CRI≥80 CRI≥90 CRI≥97
- ▶ SAA RoHS CE



L

R

Code	Watt	Size(AxBxCmm)	Cut-out(mm)	Lumen(±5%)	N.W/pc(kgs)	Q'ty/CTN
DL170-10W	10W	Ø50x61	/	1000lm	0.17	100PCS
DL170-13W	13W	Ø50x61	/	1490lm	0.17	100PCS
DL170-18W	18W	Ø50x81	/	2130lm	0.25	50PCS
DL170-75-A	Trim	Ø85x46.8x75	Ø75-80	Trim	0.08	100PCS
DL170-90-A	Trim	Ø100x45.8x90	Ø90-95	Trim	0.09	100PCS
DL170-100-A	Trim	110x35x95	95-100	Trim	0.16	80PCS
DL170-90-B	Trim	Ø100x64x90	Ø90-95	Trim	0.10	100PCS
DL170-75-B1	Trim	Ø85x34.5x70	Ø70-80	Trim	0.11	100PCS
DL170-75-B2	Trim	Ø85x34.5x70	Ø70-80	Trim	0.11	100PCS
DL170-75-C	Trim	Ø90x24.8x70	Ø70-80	Trim	0.07	100PCS
DL170-90-D	Trim	Ø110x32x90	Ø90-95	Trim	0.11	100PCS
DL170-90-E	Trim	100x50x90	90-95	Trim	0.12	100PCS

CCT ——— 2700K 3000K 4000K 5000K

Trim ——— White Black Silver

DL170 DIY module

ACC-DL170-75-A → DL170-75-A

ACC-DL170-100-A → DL170-100-A

ACC-DL170-90-B → DL170-90-B

ACC-DL170-75-B1 → DL170-75-B1

ACC-DL170-75-B2 → DL170-75-B2

ACC-DL170-75-C → DL170-75-C

ACC-DL170-90-D → DL170-90-D

ACC-DL170-90-E → DL170-90-E



TH0001A TH0001B TH0001C TH0001D

TH0001 Downlight

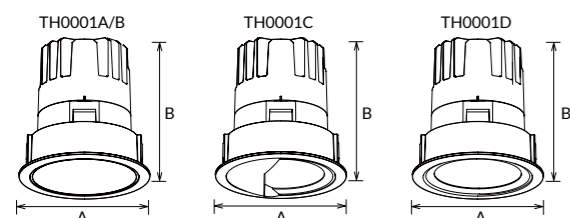

TH0001 is a trim cover exchangeable modular downlight with four optional optical modules, it's with ADC12 heat sink, PMMA lens and 15° / 24° / 36° / 50° beam angle as options. Meanwhile, it adopts magnet splice and quick clips design, make assemble and installation more convenience. UGR<19, IP20/ IP44 available, SDCM<4, it's a great luminaire which very suitable for high-end lighting applications.

- ▶ 15° 24° 36° 45° 50°
- ▶ IP20 IP44 UGR<19
- ▶ DIM Flicker Free
- ▶ AC 220-240V PF≥0.9 CRI≥90
- ▶ SAA RoHS CE

Code	Watt	Size(AxBmm)	Cut-out(mm)	Lumen(±5%)	N.W/pc(kgs)	Q'ty/CTN
TH0001A-55-4.5W	4.5W	Ø62x67	Ø55-57	350lm	0.19	24PCS
TH0001A-55-4.5W	4.5W	62x62x73	Ø55-57	350lm	0.19	24PCS
TH0001A-55-4.5W	4.5W	Ø64x68	Ø75-77	350lm	0.19	24PCS
TH0001A-55-8W	8W	Ø62x67	Ø75-77	550lm	0.19	24PCS
TH0001A-55-8W	8W	62x62x73	Ø75-77	550lm	0.19	24PCS
TH0001A-55-8W	8W	Ø64x68	Ø75-77	550lm	0.19	24PCS
TH0001B-55-4.5W	4.5W	Ø62x67	Ø105-107	350lm	0.19	24PCS
TH0001B-55-4.5W	4.5W	62x62x73	Ø105-107	350lm	0.19	24PCS
TH0001B-55-4.5W	4.5W	Ø62x67	Ø105-107	350lm	0.19	24PCS
TH0001B-55-8W	8W	Ø62x67	Ø105-107	550lm	0.19	24PCS
TH0001B-55-8W	8W	62x62x73	Ø150-152	550lm	0.19	24PCS
TH0001B-55-8W	8W	Ø62x67	Ø150-152	550lm	0.19	24PCS

TH0001A/B-75-7.5W	7.5W	Ø82x85	Ø75-77	650lm	0.29	24PCS
TH0001A/B-75-7.5W	7.5W	Ø110x85	Ø75-77	650lm	0.29	24PCS
TH0001A/B-75-7.5W	7.5W	83x83x85	Ø75-77	650lm	0.29	24PCS
TH0001A/B-75-7.5W	7.5W	110x110x85	Ø75-77	650lm	0.29	24PCS
TH0001A/B-75-7.5W	7.5W	Ø82x85	Ø75-77	650lm	0.29	24PCS
TH0001A/B-75-7.5W	7.5W	Ø110x85	Ø75-77	650lm	0.29	24PCS
TH0001A/B-75-10W	10W	Ø82x85	Ø75-77	800lm	0.29	24PCS
TH0001A/B-75-10W	10W	Ø110x85	Ø75-77	800lm	0.29	24PCS
TH0001A/B-75-10W	10W	83x83x85	Ø75-77	800lm	0.29	24PCS
TH0001A/B-75-10W	10W	110x110x85	Ø75-77	800lm	0.29	24PCS
TH0001A/B-75-10W	10W	Ø82x85	Ø75-77	800lm	0.29	24PCS
TH0001A/B-75-10W	10W	Ø110x85	Ø75-77	800lm	0.29	24PCS
TH0001A/B-75-12W	12W	Ø82x85	Ø75-77	950lm	0.29	24PCS
TH0001A/B-75-12W	12W	Ø110x85	Ø75-77	950lm	0.29	24PCS
TH0001A/B-75-12W	12W	83x83x85	Ø75-77	950lm	0.29	24PCS
TH0001A/B-75-12W	12W	110x110x85	Ø75-77	950lm	0.29	24PCS
TH0001A/B-75-12W	12W	Ø82x85	Ø75-77	950lm	0.29	24PCS
TH0001A/B-75-12W	12W	Ø110x85	Ø75-77	950lm	0.29	24PCS
TH0001A/B-75-15W	15W	Ø82x85	Ø75-77	1100lm	0.29	24PCS
TH0001A/B-75-15W	15W	Ø110x85	Ø75-77	1100lm	0.29	24PCS
TH0001A/B-75-15W	15W	83x83x85	Ø75-77	1100lm	0.29	24PCS
TH0001A/B-75-15W	15W	110x110x85	Ø75-77	1100lm	0.29	24PCS
TH0001A/B-75-15W	15W	Ø82x85	Ø75-77	1100lm	0.29	24PCS
TH0001A/B-75-15W	15W	Ø110x85	Ø75-77	1100lm	0.29	24PCS
TH0001C-75-10W	10W	Ø82x94	Ø75-77	850lm	0.37	24PCS
TH0001C-75-10W	10W	Ø110x94	Ø75-77	850lm	0.37	24PCS
TH0001C-75-14W	14W	Ø82x94	Ø75-77	1200lm	0.37	24PCS
TH0001C-75-14W	14W	Ø110x94	Ø75-77	1200lm	0.37	24PCS
TH0001D-75-10W	10W	Ø82x94	Ø75-77	1000lm	0.37	24PCS
TH0001D-75-10W	10W	Ø110x94	Ø75-77	1000lm	0.37	24PCS
TH0001D-75-14W	14W	Ø82x94	Ø75-77	1450lm	0.37	24PCS
TH0001D-75-14W	14W	Ø110x94	Ø75-77	1450lm	0.37	24PCS
TH0001A/B-105-14W	14W	Ø114x120	105-107	1250lm	0.70	12PCS
TH0001A/B-105-14W	14W	Ø114x120	105-107	1750lm	0.70	12PCS
TH0001A/B-105-14W	14W	Ø114x120	105-107	2100lm	0.70	12PCS
TH0001A/B-105-14W	14W	Ø114x120	105-107	2400lm	0.70	12PCS
TH0001A/B-150-30W	30W	Ø154x174	150-152	3100lm	1.75	6PCS
TH0001A/B-150-30W	30W	Ø154x174	150-152	3500lm	1.75	6PCS
TH0001A/B-150-30W	30W	Ø154x174	150-152	3900lm	1.75	6PCS
TH0001A/B-150-30W	30W	Ø154x174	150-152	4300lm	1.75	6PCS



TH0001A/B  Cucout Ø55mm

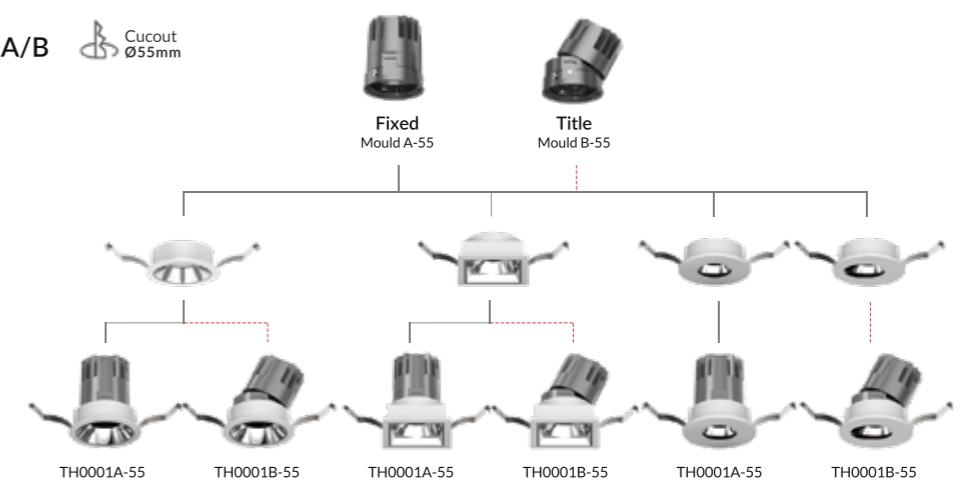

TH0001A/B  Cucout Ø75mm

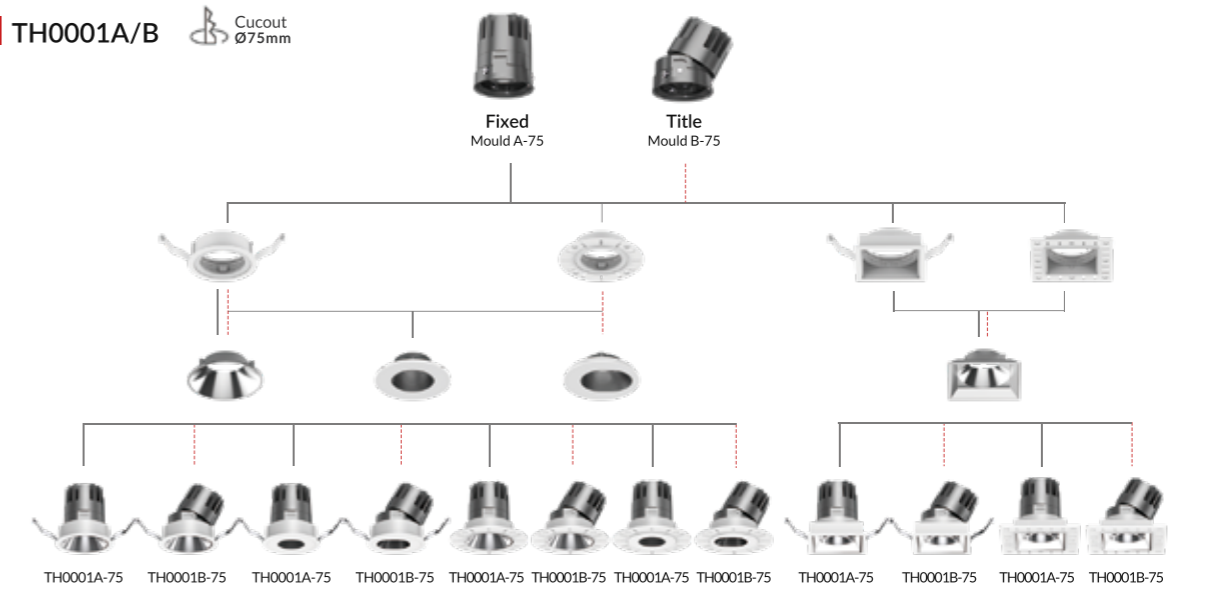

TH0001C/D  Cucout Ø75mm

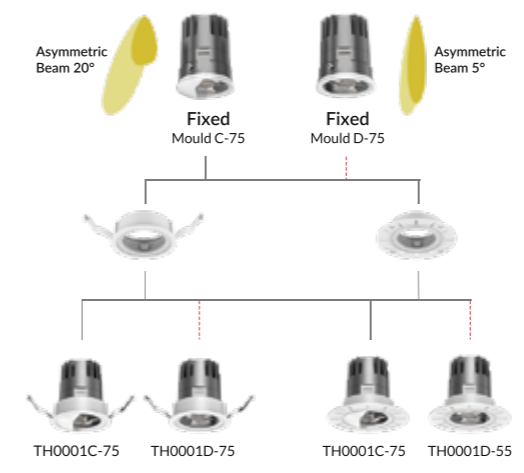

TH0001A/B  Cucout Ø105mm

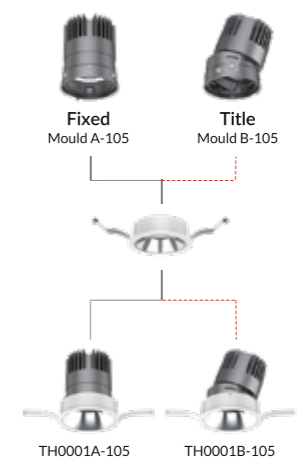

 Cucout Ø150mm

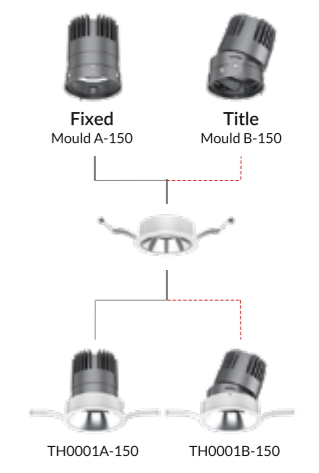



DL366 NEW Downlight

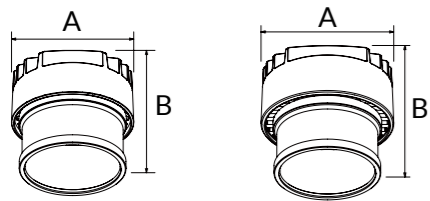

DL366 Downlight module adopts bridgelux COB and ADC12 aluminum heatsink. Various frames are selectable for different applications: fixed/ rotatable, deep fixed/ deep rotatable and surface which can reach low glare. External driver is power changeable and triac dimmable. Interchangeable CCT with slide switch is available.

- ▶ 30° 50°
- ▶ IP20 IP54
- ▶ UGR<19
- ▶ DIM
- ▶ Flicker Free
- ▶ SLIDE SWITCH 3 in 1
- ▶ AC 220-240V
- ▶ PF≥0.85 PF≥0.9
- ▶ CRI≥80
- ▶ SAA RoHS CE

Code	Watt	Size(AxBmm)	Cut-out(mm)	Lumen(±5%)	N.W/pc(kgs)	Q'ty/CTN
DL366-6W	6W	Ø57x53.5	/	790lm	0.13	24PCS
DL366-8W	8W	Ø57x53.5	/	900lm	0.13	24PCS
DL366-10W	10W	Ø62x58.5	/	1150lm	0.15	24PCS
DL366-12W	12W	Ø62x58.5	/	1350lm	0.15	24PCS

CCT ——— 2700K 3000K 4000K 5000K

Trim ——— White Black

DL366 Series



LED Downlight
COB Series





CL103 COB Downlight

CL103B SMD Downlight

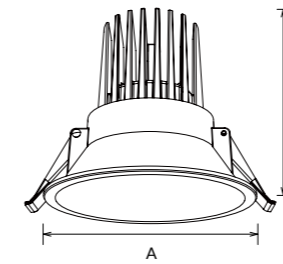
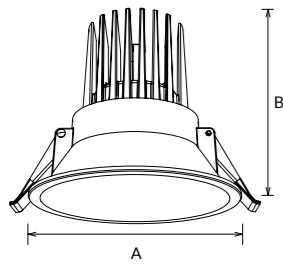

CL103 fixed downlight adopts brand CREE COB, reflector and ADC12 aluminum heatsink. Deep cone design creates low UGR. External driver is exchangeable through quick connector among non-dimmable driver, Triac dimmable, 0-10V and DALI dimmable drivers.

CL103B fixed downlight adopts high efficiency SMD LED chips, PMMA lens and ADC12 aluminum heatsink. Deep cone design creates low UGR. External driver is exchangeable through quick connector among non-dimmable driver, Triac dimmable, 0-10V and DALI dimmable drivers.

- ▶
- ▶
- ▶
- ▶

- ▶
- ▶
- ▶
- ▶

Code	Watt	Size(AxBmm)	Cut-out(mm)	Lumen(±5%)	N.W/pc(kgs)	Q'ty/CTN
CL103-3-12W	12W	Ø100x90.6	Ø90-95	1010lm	0.40	24PCS
CL103-3-12W-D	12W	Ø100x90.6	Ø90-95	980lm	0.40	24PCS

Code	Watt	Size(AxBmm)	Cut-out(mm)	Lumen(±5%)	N.W/pc(kgs)	Q'ty/CTN
CL103B-2.5-8W	8W	Ø80x100	Ø70-75	720lm	0.38	24PCS
CL103B-2.5-10W	10W	Ø80x100	Ø70-75	900lm	0.38	24PCS
CL103B-3-10W	10W	Ø100x90.6	Ø90-95	960lm	0.40	24PCS
CL103B-3-12W	12W	Ø100x90.6	Ø90-95	1140lm	0.40	24PCS

CCT — 2700K — 3000K — 4000K — 5000K

Trim — White Black

CCT — 2700K — 3000K — 4000K — 5000K

Trim — White Black



ANTI GLARE

DESIGN
with deep reflector

(UGR<19)

LED Downlight
COB Series

DL201 Downlight

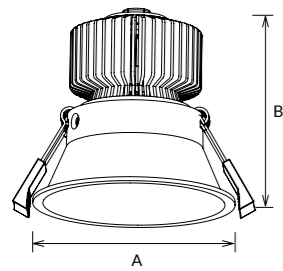

DL201 downlight adopts brand CITIZEN COB, reflector and AL6063 aluminum heatsink. Deep cone design creates low UGR<19. Fixed or rotatable optional. External driver is exchangeable through quick connector among non-dimmable driver, Triac dimmable, 0-10V and DALI dimmable drivers.

- ▶ 36° UGR<19
- ▶
- ▶

- ▶



Code	Watt	Size(AxBmm)	Cut-out(mm)	Lumen(±5%)	N.W/pc(kgs)	Q'ty/CTN
DL201A-2.5-10W	10W	Ø80x87	Ø75	910lm	0.26	36PCS
DL201B-2.5-10W	10W	Ø85x81	Ø75	910lm	0.27	36PCS
DL201-3-13W	13W	Ø100x94	Ø90	1170lm	0.32	24PCS
DL201-3.5-13W	13W	Ø105x145	Ø100	1100lm	0.38	24PCS

CCT ——— 2700K 3000K 4000K 5000K

Trim ——— White Black





CL117/CL118 Downlight

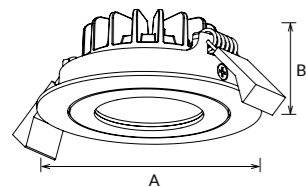

CL117 / CL118 slimline rotatable downlight adopts curve/ flat frame and exchangeable module, using brand CITIZEN COB, reflector (A) / lens (B) and ADC12 aluminum heatsink. External driver is exchangeable through quick connector between non-dimmable driver and Triac dimmable driver. Loop in/ loop out terminal makes convenient installation.

- ▶ 24° 36° 45° 60°
- ▶ IP20 IP54
- ▶ DIM DALI 0-10V Flicker Free DIM TO WARM
- ▶ AC 200-240V PF≥0.9 CRI≥80 CRI≥90 CRI≥97
- ▶ SAA RoHS CE

Code	Watt	Size(AxBmm)	Cut-out(mm)	Lumen(±5%)	N.W/pc(kgs)	Q'ty/CTN
CL117A-2.5-6W	6W	Ø80x35	Ø68-75	530lm	0.19	48PCS
CL117B-2.5-6W	6W	Ø80x35	Ø68-75	500lm	0.19	48PCS
CL117A-3-6W	6W	Ø95x49	Ø82-88	570lm	0.25	36PCS
CL117B-3-6W	6W	Ø95x49	Ø82-88	530lm	0.28	36PCS
CL117A-3-8W	8W	Ø95x49	Ø82-88	785lm	0.25	36PCS
CL117B-3-8W	8W	Ø95x49	Ø82-88	765lm	0.28	36PCS
CL117A-3-10W	10W	Ø95x49	Ø82-88	1000lm	0.25	36PCS
CL117B-3-10W	10W	Ø95x49	Ø82-88	970lm	0.28	36PCS
CL118A-2.5-6W	6W	Ø80x33	Ø68-75	530lm	0.19	48PCS
CL118B-2.5-6W	6W	Ø80x33	Ø68-75	500lm	0.19	48PCS
CL118A-3-6W	6W	Ø95x44	Ø82-88	570lm	0.25	36PCS
CL118B-3-6W	6W	Ø95x44	Ø82-88	530lm	0.27	36PCS
CL118A-3-8W	8W	Ø95x44	Ø82-88	785lm	0.25	36PCS
CL118B-3-8W	8W	Ø95x44	Ø82-88	765lm	0.27	36PCS
CL118A-3-10W	10W	Ø95x44	Ø82-88	1000lm	0.25	36PCS
CL118B-3-10W	10W	Ø95x44	Ø82-88	970lm	0.27	36PCS

CCT — 2700K 3000K 4000K 5000K

Trim — White Black Silver Nickel Brushed

CL117&CL118 DIY module

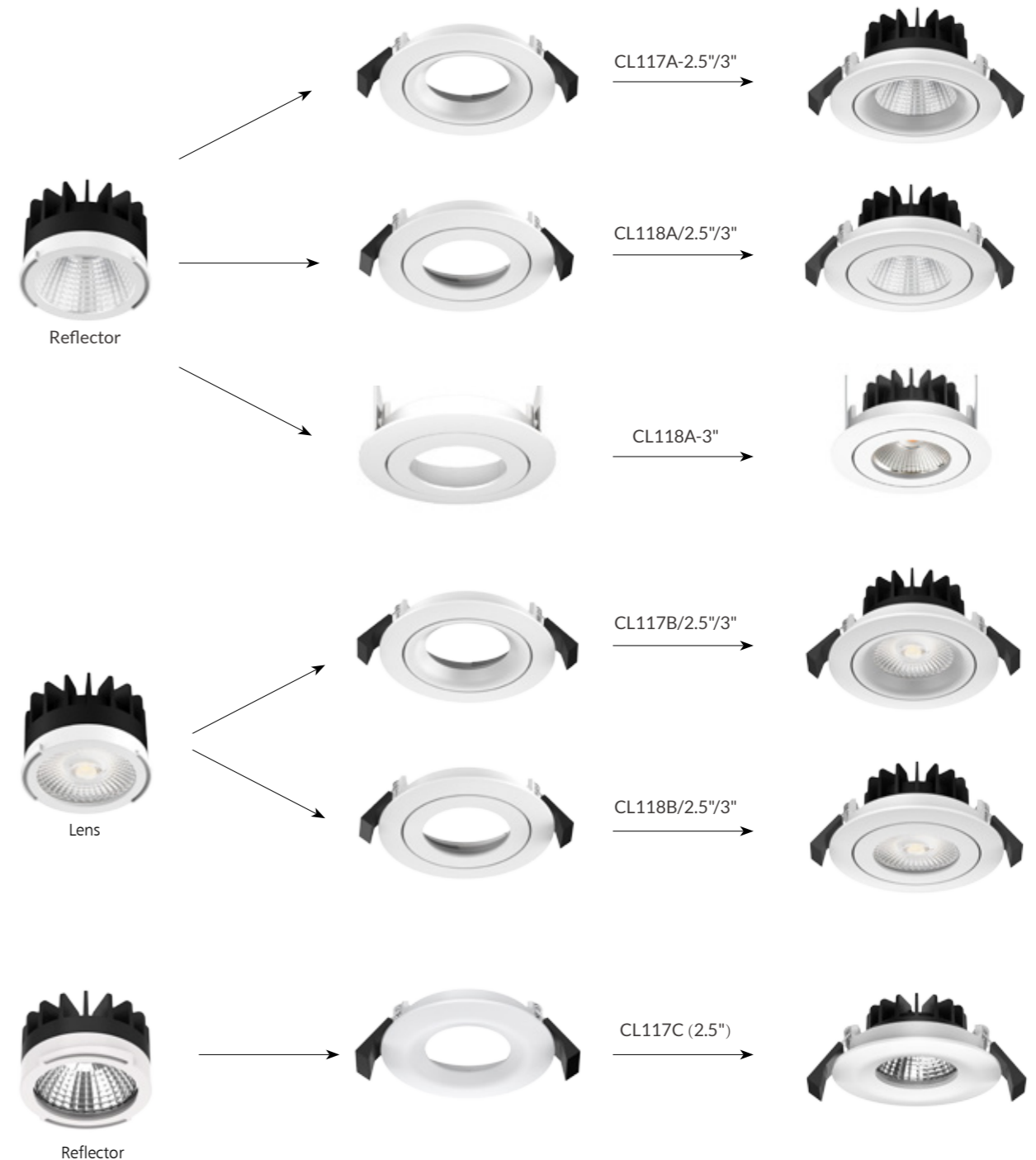



CL102 Downlight

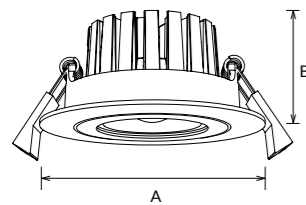

CL102 slimline IP65 rotatable downlight adopts brand CREE COB, anti-glare lens and ADC12 aluminum heatsink. External driver is exchangeable through quick connector between non-dimmable driver and Triac dimmable driver.

- ▶ IP65
- ▶
- ▶
- ▶

Code	Watt	Size(AxBmm)	Cut-out(mm)	Lumen(±5%)	N.W/pc(kgs)	Q'ty/CTN
CL102A-2.5-5W	5W	Ø80x30	Ø68-72	530lm	0.24	50PCS
CL102A-2.5-8W	8W	Ø80x30	Ø68-72	815lm	0.24	50PCS
CL102B-2.5-10W	10W	Ø90x39.3	Ø75-80	1000lm	0.25	50PCS
CL102-3-10W	10W	Ø110x49.5	Ø90-95	1000lm	0.40	30PCS
CL102-3-13W	13W	Ø110x49.5	Ø90-95	1350lm	0.40	30PCS

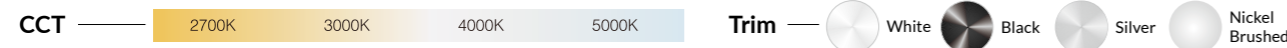

DL103 Downlight

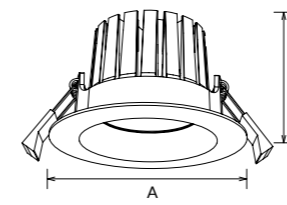

DL103 slimline IP65 fixed downlight adopts brand CREE COB, anti-glare lens and ADC12 aluminum heatsink. External driver is exchangeable through quick connector between non-dimmable driver and Triac dimmable driver.

- ▶ IP65
- ▶
- ▶
- ▶

Code	Watt	Size(AxBmm)	Cut-out(mm)	Lumen(±5%)	N.W/pc(kgs)	Q'ty/CTN
DL103A-2.5-5W	5W	Ø80x40	Ø68-72	530lm	0.18	50PCS
DL103A-2.5-8W	8W	Ø80x40	Ø68-72	815lm	0.18	50PCS
DL103B-2.5-10W	10W	Ø90x49.4	Ø75-80	1000lm	0.27	50PCS
DL103-3-10W	10W	Ø110x64.3	Ø90-95	1130lm	0.45	30PCS
DL103-3-13W	13W	Ø110x64.3	Ø90-95	1350lm	0.45	30PCS

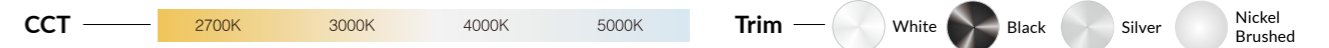

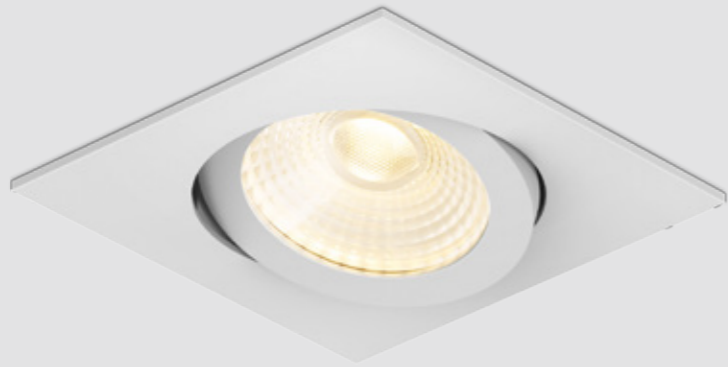

CL104 Downlight

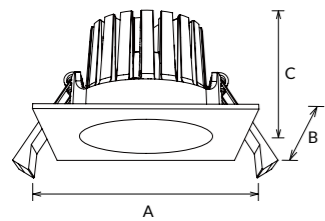

CL104 square slimline IP65 rotatable downlight adopts brand CREE COB, anti-glare lens and ADC12 aluminum heatsink. External driver is exchangeable through quick connector between non-dimmable driver and Triac dimmable driver.

- ▶ 36° 60° 30° IP65
- ▶ DIM DALI 0-10V Flicker Free
- ▶ AC 200-240V PF \geq 0.9 CRI \geq 80 CRI \geq 90 CRI \geq 97
- ▶ SAA RoHS CE CB

Code	Watt	Size(AxBxCmm)	Cut-out(mm)	Lumen(\pm 5%)	N.W/pc(kgs)	Q'ty/CTN
CL104A-2.5-5W	5W	80x80x30	Ø68-72	530lm	0.22	50PCS
CL104A-2.5-8W	8W	80x80x30	Ø68-72	815lm	0.22	50PCS
CL104B-2.5-10W	10W	90x90x39	Ø75-80	1000lm	0.26	50PCS
CL104-3-10W	10W	110x110x50	Ø90-95	1000lm	0.35	30PCS
CL104-3-13W	13W	110x110x50	Ø90-95	1350lm	0.35	30PCS

CCT — 2700K 3000K 4000K 5000K Trim —



DL104 Downlight

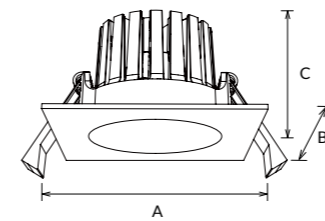

DL104 square slimline IP65 fixed downlight adopts brand CREE COB, anti-glare lens and ADC12 aluminum heatsink. External driver is exchangeable through quick connector between non-dimmable driver and Triac dimmable driver.

- ▶ 36° 60° IP65
- ▶ DIM DALI 0-10V Flicker Free
- ▶ AC 200-240V PF \geq 0.9 CRI \geq 80 CRI \geq 90 CRI \geq 97
- ▶ SAA RoHS CE

Code	Watt	Size(AxBxCmm)	Cut-out(mm)	Lumen(\pm 5%)	N.W/pc(kgs)	Q'ty/CTN
DL104A-2.5-5W	5W	80x80x40	Ø68-72	530lm	0.22	50PCS
DL104A-2.5-8W	8W	80x80x40	Ø68-72	815lm	0.22	50PCS
DL104B-2.5-10W	10W	90x90x49	Ø75-80	1000lm	0.28	50PCS
DL104-3-10W	10W	110x110x64	Ø90-95	1130lm	0.39	30PCS
DL104-3-13W	13W	110x110x64	Ø90-95	1350lm	0.39	30PCS

CCT — 2700K 3000K 4000K 5000K Trim —



DL63 Downlight

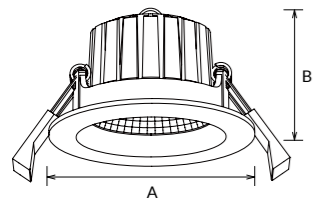

DL63 Mini downlight is with standard cutout size of 70mm. 24°/36°/60° beam angle provided, CRI80/90/97 optional, it is applicable for various lighting effect. Waterproof structural design, IP54 protection grade, ideally for damp locations.

- ▶ 24° 36° 60°
- ▶ IP20 IP54
- ▶ DIM DALI 0-10V Flicker Free DIM TO WARM
- ▶ AC 200-240V PF≥0.9 CRI≥80 CRI≥90 CRI≥97
- ▶ SAA RoHS CE

Code	Watt	Size(AxBmm)	Cut-out(mm)	Lumen(±5%)	N.W/pc(kgs)	Q'ty/CTN
DL63-2.5-5W	5W	Ø80x55	Ø68-74	450lm	0.28	48PCS
DL63-2.5-8W	8W	Ø80x55	Ø68-74	590lm	0.28	48PCS
DL63-2.5-8W-P	8W	Ø80x55	Ø68-74	400lm	0.28	48PCS

CCT — 2700K 3000K 4000K 5000K

Trim — White Black Silver Nickel Brushed

DL64 Downlight

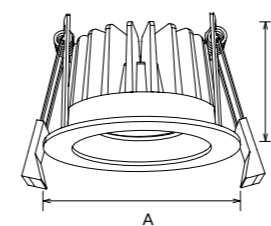

DL64 downlight adopts super high lumen COB and excellent light transmittance prismatic lens. 36°/60° beam angle are available. Cutout 70-75mm, an ideal replacement for traditional lamps.

- ▶ 36° 60°
- ▶ IP40
- ▶ DIM DALI 0-10V Flicker Free
- ▶ AC 200-240V PF≥0.9 CRI≥80 CRI≥90 CRI≥97
- ▶ SAA RoHS CE

Code	Watt	Size(AxBmm)	Cut-out(mm)	Lumen(±5%)	N.W/pc(kgs)	Q'ty/CTN
DL64-2.5-10W	10W	Ø82x58	Ø70-75	1010lm	0.25	48PCS

CCT — 2700K 3000K 4000K 5000K

Trim — White Black Silver Nickel Brushed



CL76 Downlight

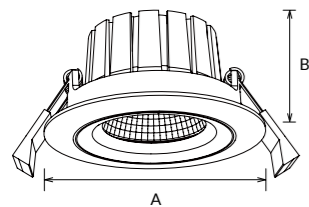

CL76 Mini down light CL76 is specially designed for European market with standard cutout size of 83mm. 15°/24°/36°/60° beam angle are provided. Combined of COB LED and PC reflector. 25 degree flexible rotary head makes installation easier and better. CRI80/90/97 optional, dim to warm is available.

- ▶ 15° 24° 36° 60°
- ▶ IP20 IP54 25°
- ▶ DIM DALI 0-10V Flicker Free DIM TO WARM
- ▶ AC 200-240V PF≥0.9 CRI≥80 CRI≥90 CRI≥97
- ▶ SAA RoHS CE

Code	Watt	Size(AxBmm)	Cut-out(mm)	Lumen(±5%)	N.W/pc(kgs)	Q'ty/CTN
CL76-3-7W-D	7W	Ø95x55	Ø82-88	560lm	0.40	24PCS
CL76-3-10W-D	10W	Ø95x55	Ø82-88	740lm	0.40	24PCS
CL76-3-7W-DW	7W	Ø95x55	Ø82-88	500lm	0.40	24PCS
CL76-3-10W-DW	10W	Ø95x55	Ø82-88	700lm	0.40	24PCS

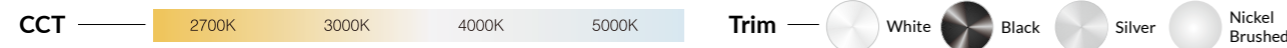

CL76B Downlight

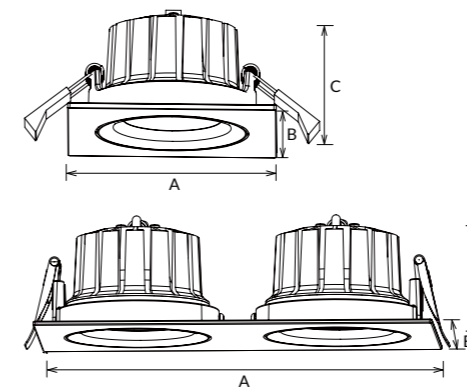

CL76B is a square COB LED downlight with aluminum die-casting housing. It could be tilted 25 degree, 15°/24°/36°/60° beam angle for selection. Dim to warm(2000K~3000K) and flicker free external driver are available.

- ▶ 15° 24° 36° 60° 25°
- ▶ IP20 IP54
- ▶ DIM DALI 0-10V Flicker Free DIM TO WARM
- ▶ AC 220-240V PF≥0.9 CRI≥80 CRI≥90 CRI≥97
- ▶ SAA RoHS CE

Code	Watt	Size(AxBxCmm)	Cut-out(mm)	Lumen(±5%)	N.W/pc(kgs)	Q'ty/CTN
CL76B-3-10W	10W	95x95x55	Ø82-88	770lm	0.34	48PCS
CL76B-20W	20W	190x95x55	182x85	1850lm	0.50	24PCS

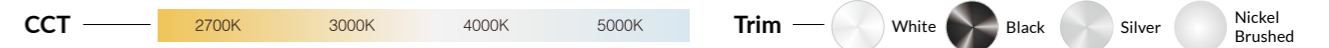



CL78 Downlight

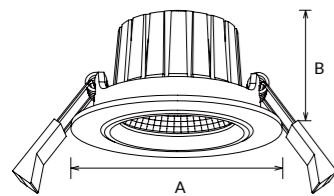

CL78 Mini down light CL78 with 24°/36°/60° beam angle is applicable for various lighting effects. With IP54 waterproof design, it is the ideal for damp locations. 25 degree flexible rotary head makes installation easier and better. CRI80/90/97 optional, dim to warm is available.

- ▶ 24° 36° 60° 25° IP20
IP54
- ▶ DIM DALI 0-10V Flicker Free DIM TO WARM
- ▶ AC 200-240V PF \geq 0.9 CRI \geq 80 CRI \geq 90 CRI \geq 97
- ▶ SAA RoHS CE

Code	Watt	Size(AxBmm)	Cut-out(mm)	Lumen(±5%)	N.W/pc(kgs)	Q'ty/CTN
CL78-2.5-5W	5W	Ø80x50	Ø68-74	450lm	0.27	48PCS
CL78-2.5-8W	8W	Ø80x50	Ø68-74	600lm	0.27	48PCS
CL78-2.5-8W-P	8W	Ø80x50	Ø68-74	400lm	0.27	48PCS

CL79 Downlight

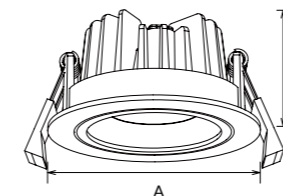

Mini down light CL79 achieves 100lm/W high efficiency with super high lumen COB and excellent light transmittance prismatic lens. It has 22° vertically adjustable lighting directions. External driver makes easier maintenance.

- ▶ 36° 60° 22° IP40
- ▶ DIM DALI 0-10V Flicker Free
- ▶ AC 200-240V PF \geq 0.85 PF \geq 0.9 CRI \geq 80 CRI \geq 90 CRI \geq 97
- ▶ SAA RoHS CE

Code	Watt	Size(AxBmm)	Cut-out(mm)	Lumen(±5%)	N.W/pc(kgs)	Q'ty/CTN
CL79-2.5-10W	10W	Ø90x46	Ø84	1010lm	0.26	48PCS

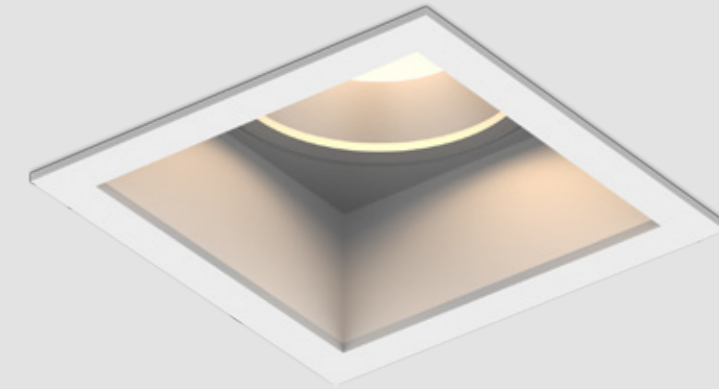

CL79A/B Downlight

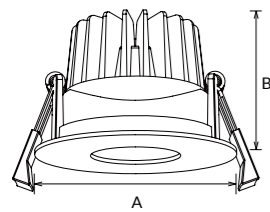

This Mini down light achieves 100lm/W high efficiency with super high lumen COB and excellent light transmittance prismatic lens. It has adjustable head for different lighting directions. External driver makes easier maintenance.

- ▶ 36° 5° IP40
- ▶ DIM DALI 0-10V Flicker Free
- ▶ AC 200-240V PF≥0.5 PF≥0.9 CRI≥80 CRI≥90 CRI≥97
- ▶ SAA RoHS CE

Code	Watt	Size(AxBmm)	Cut-out(mm)	Lumen(±5%)	N.W/pc(kgs)	Q'ty/CTN
CL79A-2.5-10W	10W	Ø91.5x61	Ø84	800lm	0.26	48PCS
CL79B-2.5-10W	10W	Ø91.5x61	Ø84	800lm	0.26	48PCS

CL79C Downlight

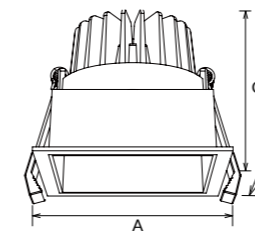

This Mini down light achieves 100lm/W high efficiency with super high lumen COB and excellent light transmittance prismatic lens. It has 22° vertically adjustable lighting directions. External driver makes easier maintenance.

- ▶ 36° 60° 22° IP40
- ▶ DIM DALI 0-10V Flicker Free
- ▶ AC 200-240V PF≥0.5 PF≥0.9 CRI≥80 CRI≥90 CRI≥97
- ▶ SAA RoHS CE

Code	Watt	Size(AxBxCmm)	Cut-out(mm)	Lumen(±5%)	N.W/pc(kgs)	Q'ty/CTN
CL79C-2.5-10W	10W	90x90x76	84x84	1020lm	0.30	48PCS



DL123 Downlight

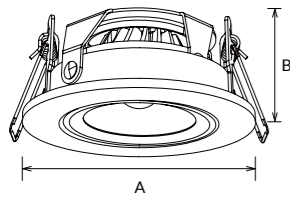

Mini gyro downlight DL123, adopts high lumen COB LED, high energy efficacy and high CRI and tight focus. DL123 downlight is ideally suitable for a variety of applications. With the adjustable and rotatable luminaire, it perfectly meets the demands of different lighting angle.

- ▶ 36° 60° 20° IP20
- ▶ DIM Flicker Free
- ▶ AC 200-240V PF≥0.5 PF≥0.9 CRI≥80 CRI≥90 CRI≥97
- ▶ SAA RoHS CE

Code	Watt	Size(AxBmm)	Cut-out(mm)	Lumen(±5%)	N.W/pc(kgs)	Q'ty/CTN
DL123-2.5-6W	6W	Ø80x37	Ø72-75	615lm	0.21	40PCS

CCT ——— 2700K 3000K 4000K 5000K

Trim ——— White Black



LED Downlight
COB Series



DL341 Downlight

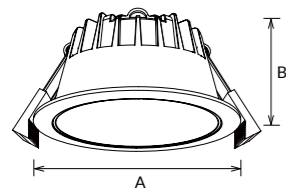

DL341 is an anti-glare downlight as deep reflector design as UGR<19 in White,UGR<23 in black. It adopts high lumen COB light source, and Aluminum die-casting heatsink. The lampshade can be replaced easily.

- ▶ 36° 55°
- ▶ IP20 IP54
- ▶ UGR<19 UGR<23
- ▶ DIM DALI Flicker Free DIM TO WARM SLIDE SWITCH 3 in 1
- ▶ AC 220-240V PF≥0.85 CRI≥80 CRI≥90 CRI≥97
- ▶ SAA RoHS CE

Code	Watt	Size(AxBmm)	Cut-out(mm)	Lumen(±5%)	N.W/pc(kgs)	Q'ty/CTN
DL341A-2.5-6W	6W	Ø80x46	Ø68-75	620lm	0.21	30PCS
DL341A-2.5-8W	8W	Ø80x46	Ø68-75	850lm	0.21	30PCS
DL341B-2.5-6W	6W	Ø95x51	Ø80-85	650lm	0.21	30PCS
DL341B-2.5-8W	8W	Ø95x51	Ø80-85	890lm	0.21	30PCS
DL341-3-8W	8W	Ø102x51	Ø90-95	890lm	0.26	30PCS
DL341-3-10W	10W	Ø102x51	Ø90-95	1080lm	0.26	30PCS

CCT ——— 2700K 3000K 4000K 5000K

Trim ——— White Black

Lampshade ——— ACC-DL341A-BK ACC-DL341A-WT

DL88 Downlight

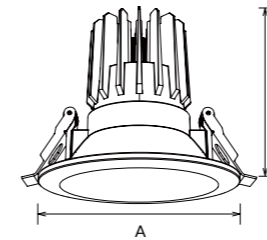

DL88 down light is unique designed with deep reflector. ADC12 aluminum profile provides excellent thermal dissipation. Isolated driver solution both in dimmable and non-dimmable version achieved a great dimming compatibility with worldwide brand dimmers.

- ▶ 24° 60°
- ▶ IP20
- ▶ DIM DALI 0-10V Flicker Free
- ▶ AC 200-240V PF≥0.9 CRI≥80 CRI≥90 CRI≥97
- ▶ SAA RoHS CE

Code	Watt	Size(AxBmm)	Cut-out(mm)	Lumen(±5%)	N.W/pc(kgs)	Q'ty/CTN
DL88-2.5-10W	10W	Ø85x89	Ø68-75	860lm	0.27	24PCS
DL88-2.5-13W	13W	Ø85x89	Ø68-75	1190lm	0.27	24PCS
DL88-3-13W	13W	Ø110x98	Ø90-95	1190lm	0.35	24PCS

CCT ——— 2700K 3000K 4000K 5000K

Trim ——— White Black



DL165



CL165



DL165/CL165 NEW Downlight

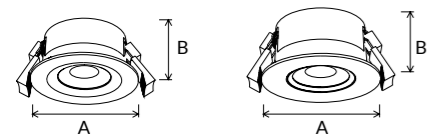

DL165 is fixed design, CL165 is gyro design. Adopt high lumen SMD LED, ADC12 aluminum housing provides a great heat dissipation. The luminaire is tilted 25° in all directions (360°), perfectly meet the demands of different lighting angle. CCT changeable by slide switch is available.

- ▶
- ▶
- ▶
- ▶

Code	Watt	Size(AxBmm)	Cut-out(mm)	Lumen(±5%)	N.W/pc(kgs)	Q'ty/CTN
DL165-2.5-5W-P2	5W	Ø78x37	Ø68	625lm	0.22	36PCS
CL165-2.5-5W-P2	5W	Ø80x40	Ø68	625lm	0.22	36PCS
DL165-3-7W-P2	7W	Ø93x37	Ø83	875lm	0.25	36PCS
CL165-3-7W-P2	7W	Ø93x40	Ø83	875lm	0.25	36PCS

CL140 Downlight

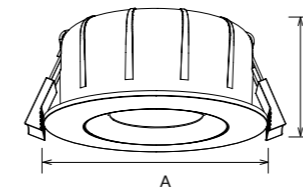

This downlight is a gyro design, it has a rear cover which is suitable for covering with insulation material directly. Adopt high lumen COB light source, ADC12 aluminum housing provides a great heat dissipation. 15°/24°/36°/60° beam angle provided, available for Dim to warm 2000-3000K. Lamp with female plug, driver with male plug, which make an easier installation. Tilt 23° in all directions(360°).

- ▶
- ▶
- ▶
- ▶
- ▶

Code	Watt	Size(AxBmm)	Cut-out(mm)	Lumen(±5%)	N.W/pc(kgs)	Q'ty/CTN
CL140-2.5-8W-D	8W	Ø96x44	Ø83	890lm	0.26	40PCS
CL140-2.5-8W-DW	8W	Ø96x44	Ø83	450lm	0.26	40PCS



CL391 NEW Downlight

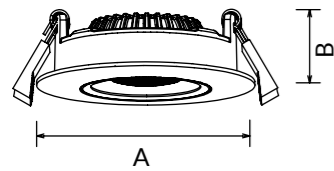

CL391 LED downlight is super slim design with height 33mm, dopting high lumen SMD 120lm/W, PC lens with uniform light. ADC12 Aluminum profile provides excellent thermal dissipation. Interchangeable CCT with slide switch is available. IP54 waterproof for front side.

- ▶
- ▶
- ▶
- ▶
- ▶

Code	Watt	Size(AxBmm)	Cut-out(mm)	Lumen(±5%)	N.W/pc(kgs)	Q'ty/CTN
CL391-2.5-5W	5W	Ø92x33	Ø83-85	600lm	0.28	36PCS
CL391-2.5-8W	8W	Ø92x33	Ø83-85	960lm	0.28	36PCS

CL128 Downlight

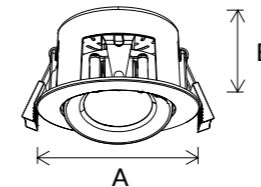

CL128 LED downlight is gyro design which is suitable for covering with insulation material directly. It adopts high lumen COB light source, ADC12 aluminum housing provides a great heat dissipation. Different lighting angle with tilt 30° in all directions(360°) and Dim-to-Warm version (2000K~3000K) are available.

- ▶
- ▶
- ▶
- ▶
- ▶

Code	Watt	Size(AxBmm)	Cut-out(mm)	Lumen(±5%)	N.W/pc(kgs)	Q'ty/CTN
CL128-2.5-8W-D	8W	Ø95x50	Ø83-86	864lm	0.30	40PCS
CL128-2.5-8W-DW	8W	Ø95x50	Ø83-86	445lm	0.30	40PCS



CL148 Downlight

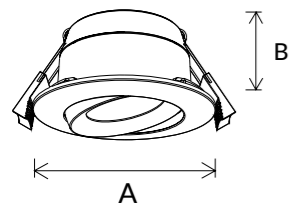

CL148 is a gyro design downlight. It is tilted 23° in all directions (360°), perfectly meet the demands of different lighting angle. Dim to Warm version (2000K-2800K/3000K) for option, suitable for covering directly under insulation material. Two cutout size options: 68mm without ring, 83mm with ring. Driver with fast connector inside to provide very convenient wiring connection.

- ▶ 15° 24° 36° 60° 360°
- ▶ 23° IP20/IP54
- ▶ DIM Flicker Free
- ▶ AC 220-240V PF ≥ 0.9 CRI ≥ 80 CRI ≥ 90 CRI ≥ 95
- ▶ SAA RoHS CE

Code	Watt	Size(AxBmm)	Cut-out(mm)	Lumen(±5%)	N.W/pc(kgs)	Q'ty/CTN
CL148-2.5-6W-D	6W	Ø90x48	68/83	650	0.3	1PCS
CL148-2.5-8W-D	8W	Ø90x48	68/83	800	0.3	1PCS

CCT — 2700K 3000K 4000K 5000K

Trim — White Black

CL148 GYRO DESIGN DOWNLIGHT



Direct insulation cover



LED Downlight
COB Series



CEILING CUTOUT
68mm



Airtight design



CEILING CUTOUT
83mm



ACC-CL148



23°



Tilt 23° in all directions (360°)

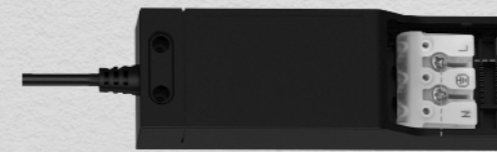

Loop in loop out



K3



K4

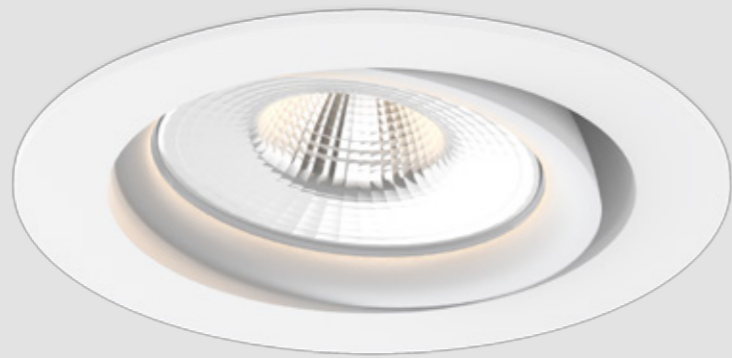

CL164 NEW Downlight

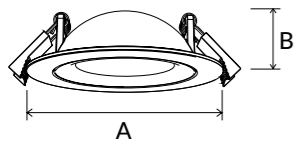

CL164 nordic style downlight with only 30mm height. It has flexible rotary lighting angle with vertically 90° and horizontally 350°. High lumen efficiency 110lm/W, dim to warm (2000-3000K), IP54 waterproof, triac / 0-10V / DALI dimming available.

- ▶
- ▶
- ▶
- ▶

Code	Watt	Size(AxBmm)	Cut-out(mm)	Lumen(±5%)	N.W/pc(kgs)	Q'ty/CTN
DL164-2.5-7W	7W	Ø95x30	Ø75-85	850lm	0.20	24PCS
DL164-2.5-7W-DW	7W	Ø95x30	Ø75-85	420lm	0.20	24PCS

CCT ——— 2700K — 3000K — 4000K — 5000K

Trim ——— White Black

30MM Super Slim



IP54

90°

Efficiency
110LM/W

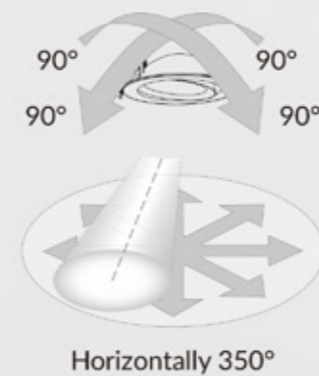

Dim to warm





CL168A COB

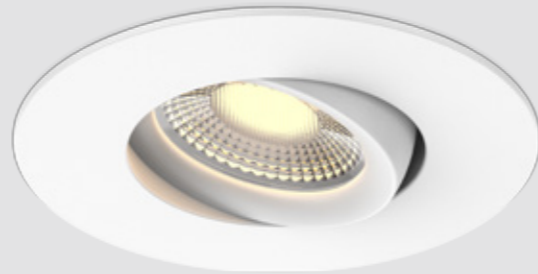

CL168B SMD



DL392A



DL392B

CL168 NEW Downlight

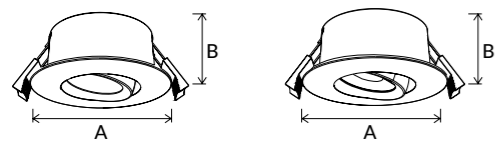

CL168 nordic style downlight with COB and SMD design, mini size for cutout 75-83mm. Aluminum profile provides excellent thermal dissipation. Interchangeable CCT with slide switch and DIM to warm(2000K-3000K) are available, IP54 waterproof for front side. CRI90 and CRI95 for options.

- ▶ IP20
IP54
- ▶ DIM
Flicker Free
- ▶ AC
220-240V PF≥0.9 CRI≥90 CRI≥97
- ▶ SAA RoHS CE

Code	Watt	Size(AxBmm)	Cut-out(mm)	Lumen(±5%)	N.W/pc(kgs)	Q'ty/CTN
CL168A-2.5-7W-D	7W	Ø95x39.5	Ø75-83	730lm	0.23	36PCS
CL168A-2.5-7W-DW	7W	Ø95x39.5	Ø75-83	420lm	0.23	36PCS
CL168B-2.5-7W-D	7W	Ø95x39.5	Ø75-83	850lm	0.24	36PCS
CL168B-2.5-7W-P3	7W	Ø95x39.5	Ø75-83	880lm	0.23	36PCS

CCT — 2700K 3000K 4000K 5000K 5700K Trim — White Black Silver Nickel

DL392 NEW Downlight

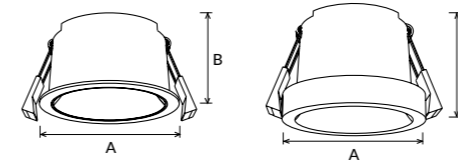

DL392 downlight is an anti-glare design as deep reflector. DL391A as SMD LED can reach 125lm/w and 3CCT changeable available. DL392B as COB LED & PMMA trim can reach 100lm/W, special for ambient lighting. Die casting lamp body provides excellent thermal dissipation.

- ▶ 15° 24° 36° 40° 55°
- ▶ IP40
- ▶ DIM DALI 0-10V Flicker Free SLIDE SWITCH 3 in 1
- ▶ AC
220-240V PF≥0.8 CRI≥80 CRI≥90 CRI≥97
- ▶ SAA RoHS CE

Code	Watt	Size(AxBmm)	Cut-out(mm)	Lumen(±5%)	N.W/pc(kgs)	Q'ty/CTN
DL392A-2.5-5W	5W	Ø76x45	Ø66-70	600lm	0.20	36PCS
DL392A-2.8-8W	8W	Ø76x45	Ø66-70	960lm	0.20	36PCS
DL392B-2.5-5W	5W	Ø80x57.5	Ø66-70	500lm	0.23	36PCS
DL392B-2.8-8W	8W	Ø80x57.5	Ø66-70	800lm	0.23	36PCS
DL392A-2.5-8W	8W	Ø90x49	Ø81-85	960lm	0.25	24PCS
DL392A-2.5-10W	10W	Ø90x49	Ø81-85	1200lm	0.25	24PCS
DL392B-2.5-8W	8W	Ø95x61.5	Ø81-85	800lm	0.30	24PCS
DL392B-2.5-10W	10W	Ø95x61.5	Ø81-85	1000lm	0.30	24PCS

CCT — 2700K 3000K 4000K 5000K 5700K Trim — White



CL350 Downlight

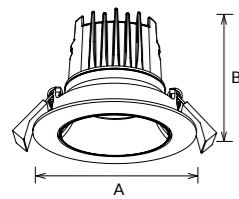

CL350 LED mini downlight with Citizen COB and ADC 12 aluminum housing. It is flicker free and external driver design. IP44 for front and UGR<16 are available.

- ▶
- ▶
- ▶
- ▶

Code	Watt	Size(AxBmm)	Cut-out(mm)	Lumen(±5%)	N.W/pc(kgs)	Q'ty/CTN
CL350-2-6W	6W	Ø80x60	Ø68-72	540lm	0.23	36PCS
CL350-2.5-8W	8W	Ø90x67	Ø75-83	800lm	0.27	36PCS

DL350 Downlight

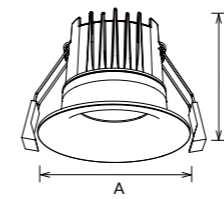

DL350 LED mini downlight with Citizen COB and ADC 12 aluminum housing. It is flicker free and external driver design. IP44 for front and UGR<16 are available.

- ▶
- ▶
- ▶
- ▶

Code	Watt	Size(AxBmm)	Cut-out(mm)	Lumen(±5%)	N.W/pc(kgs)	Q'ty/CTN
DL350-2-8W	8W	Ø80x67	Ø68-72	800lm	0.25	40PCS
DL350-2.5-10W	10W	Ø90x72	Ø75-83	1000lm	0.28	40PCS



DL301 Series
UGR<19

Triac dimmable | CRI≥80 | External flicker free driver



DL301 Cabinet light

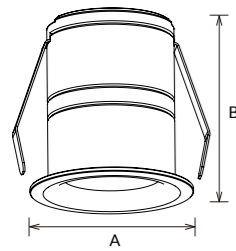

DL301 is LED mini downlight design, which is suitable applied for specialty store, display cabinet, jewelry cabinet, kitchen cabinet, hotel, and home. Low glare UGR<19 provide high visual experience.

- ▶ 20° 24° 30°
- ▶ IP40 IP54
- ▶ UGR<19
- ▶ DIM Flicker Free
- ▶ AC 200-240V PF≥0.8 CRI≥80
- ▶ SAA RoHS CE

Code	Watt	Size(AxBmm)	Cut-out(mm)	Lumen(±5%)	N.W/pc(kgs)	Q'ty/CTN
DL301-30-3W-D	3W	Ø35x46	Ø30	170lm	0.10	48PCS
DL301-40-5W-D	5W	Ø45x49	Ø40	350lm	0.13	48PCS
DL301-50-7W-D	7W	Ø55x53	Ø50	490lm	0.18	48PCS



CCT ——— 2700K 3000K 4000K 5000K

Trim ——— White Black

white
 black
10% lumen decrease
in black color



DL363 ^{NEW} Cabinet light

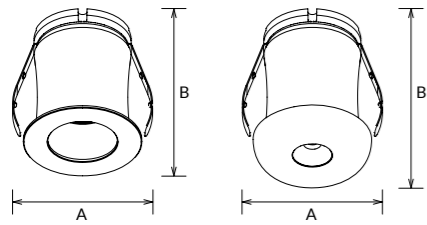

DL363 mini spotlight is with minimal design, adopting COB LED, PC reflector with uniform light, interchangeable CCT with slide switch available. DL363A as AC220-240V and DL363B as AC/DC24V, can be 3-way and 6-way distributor for options

- Beam angles: 20°, 25°, 30°, 36°
- IP20
- Features: DIM, Flicker Free, SLIDE SWITCH 3 in 1
- Specifications: AC 220-240V, AC/DC 24V, PF≥0.8, CRI≥80
- Certifications: SAA, RoHS, CE

Code	Watt	Size(AxBmm)	Cut-out(mm)	Lumen(±5%)	N.W/pc(kgs)	Q'ty/CTN
DL363A-30-3W	3W	Ø35x44	Ø30	135lm	0.08	48PCS
DL363A-40-5W	5W	Ø45x55	Ø40	350lm	0.11	48PCS
DL363A-50-7W	7W	Ø55x61	Ø50	560lm	0.13	48PCS
DL363B-30-3W	3W	Ø35x44	Ø30	145lm	0.30(3-way) 0.58(6-way)	24PCS(3-way) 12PCS(6-way)
DL363B-40-5W	5W	Ø45x55	Ø40	380lm	0.38(3-way) 0.73(6-way)	24PCS(3-way) 12PCS(6-way)
DL363B-50-7W	7W	Ø55x61	Ø50	580lm	0.47(3-way) 0.90(6-way)	24PCS(3-way) 12PCS(6-way)

CCT: 2700K, 3000K, 4000K, 5000K | Trim: White, Black, Golden



DL278 Cabinet light

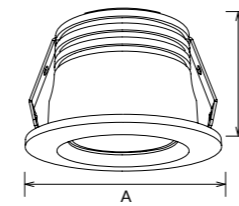

DL278 minimises and recessed spot design makes the luminaire glare free, adopting high quality brand COB as symmetric lighting, flicker free external driver. CRI>80 or CRI>90 for options. AL6063 die-casting lamp body provides great heat dissipation. Several beam angles available, such as 15°/24°/32°/36°. Attractive as a decor light recessed into window nooks and furniture.

- Beam angles: 15°, 20°, 24°, 32°, 36°
- IP20, IP40
- Features: SLIDE SWITCH 3 in 1, Flicker Free
- Specifications: AC 220-240V, PF≥0.5, CRI≥80, CRI≥90
- Certifications: SAA, RoHS, CE

Code	Watt	Size(AxBmm)	Cut-out(mm)	Lumen(±5%)	N.W/pc(kgs)	Q'ty/CTN
DL278-1-1.8W	1.8W	Ø30x26	Ø25	115lm	0.04	48PCS
DL278-1.4-3.3W	3.3W	Ø40x26	Ø35	280lm	0.06	48PCS
DL278B-1.4-3W	3W	Ø40x35	Ø35	280lm	0.06	60PCS

CCT: 2700K, 3000K, 4000K | Trim: White, Black



CL138 Cabinet light

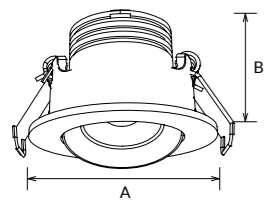

CL138 minimises and recessed spot design makes the luminaire glare free. With adjustable head version (Tilting angle is $\pm 20^\circ$). Flicker free external driver, CRI > 80 or CRI > 90 for options. AL6063 die-casting lamp body provides great heat dissipation. Several beam angles available, such as 15°/20°/24°/32°. Attractive as a decor light recessed into window nooks and furniture.

- ▶
- ▶
- ▶
- ▶

Code	Watt	Size(AxBmm)	Cut-out(mm)	Lumen(±5%)	N.W/pc(kgs)	Q'ty/CTN
CL138-1.8-3W	3W	Ø50x30	Ø45	210lm	0.09	60PCS

CCT ——— 2700K ——— 3000K ——— 4000K

Trim ——— White Black

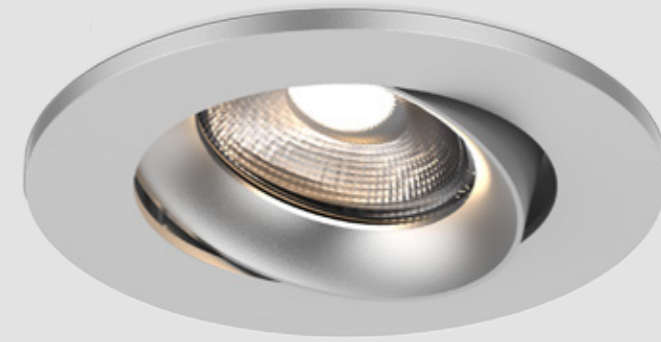

CL161 NEW Cabinet light

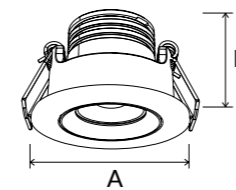

CL161 LED mini cabinet lamp with low height 34mm, equipped with DC24V light source, 20degree tilted design and waterproof fast connector. casting lamp body provides excellent thermal dissipation. 1 way or multiple-way distributor for options

- ▶
- ▶
- ▶
- ▶



Code	Watt	Size(AxBmm)	Cut-out(mm)	Lumen(±5%)	N.W/pc(kgs)	Q'ty/CTN
CL161-1.8-4W	4W	Ø50x34	Ø45	380lm	0.11	48PCS

CCT ——— 3000K ——— 4000K ——— 5000K ——— 5700K

Trim ——— Silver



DL221

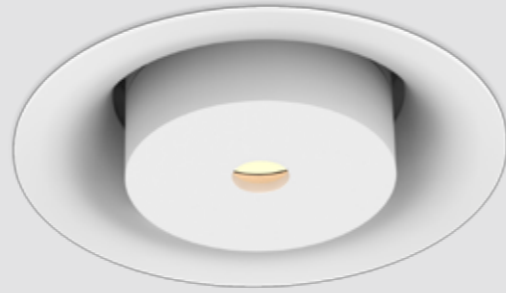

CL221



DL221/CL221 NEW Cabinet light

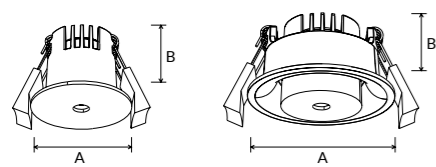

DL221/CL221 LED mini downlight with external driver, small beam angle like a star. ADC12 Aluminum profile provides excellent thermal dissipation. It is anti-glare design with UGR<19.

- ▶ 33°
- ▶ IP20
- ▶ UGR<19
- ▶ Flicker Free
- ▶ AC 220-240V
- ▶ PF≥0.5
- ▶ CRI≥90
- ▶ SAA
- ▶ RoHS
- ▶ CE

Code	Watt	Size(AxBmm)	Cut-out(mm)	Lumen(±5%)	N.W/pc(kgs)	Q'ty/CTN
DL221-40-3W	3W	Ø50x39	Ø40	125lm	0.09	48PCS
CL221-60-3W	3W	Ø69x41	Ø60	125lm	0.15	48PCS

CCT — 2700K — 3000K — 4000K

Trim — White Black

DL202 Cabinet light

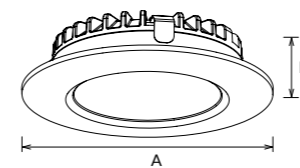

DL202 LED under cabinet light with ADC12 aluminum light body, providing good heat dissipation. 70 degree beam angle with lens. Adopting 12V constant voltage driver, 3-way and 6-way distributor for options.

- ▶ 70°
- ▶ IP20
- ▶ IP54
- ▶ Flicker Free
- ▶ AC 100-240V
- ▶ PF≥0.5
- ▶ CRI≥80
- ▶ SAA
- ▶ RoHS
- ▶ CE



Code	Watt	Size(AxBmm)	Cut-out(mm)	Lumen(±5%)	N.W/pc(kgs)	Q'ty/CTN
DL202-3.5W	3.5W	Ø70x17	Ø58	300lm	0.08*3	30*3PCS
driver with 3-way distributor	/	/	/	/	0.13	90PCS
driver with 6-way distributor	/	/	/	/	0.14	90PCS

CCT — 2700K — 3000K — 4000K — 5000K

Finish — White Black



DL391 NEW Cabinet light

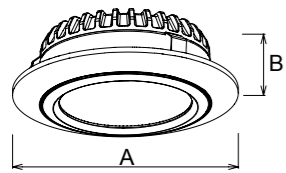

DL391 LED cabinet light with ADC12 aluminum light body, providing good heat dissipation. AC220 driver and DC24V constant voltage driver, 3-way and 6-way distributor for options. It supports both recessed and surface mounted installation. Interchangeable CCT and IP54 waterproof for front side are available.

- ▶ IP40
IP54
70°
- ▶ DIM
Flicker Free
SLIDE SWITCH
3 in 1
- ▶ AC
220-240V
DC
24V
PF ≥ 0.8
CRI ≥ 80
- ▶ SAA
RoHS
CE



Code	Watt	Size(AxBmm)	Cut-out(mm)	Lumen(±5%)	N.W/pc(kgs)	Q'ty/CTN
DL391-3W	3W	Ø70x25	Ø58-60	580lm	0.20	30PCS

CCT ——— 3000K 4000K 5000K 5700K

Trim ——— White Nickel

Conversion ring ——— ACC-DL391-70-WT/NK ACC-DL391-104-WT/NK

CABINET

Recessed to Surface mounted

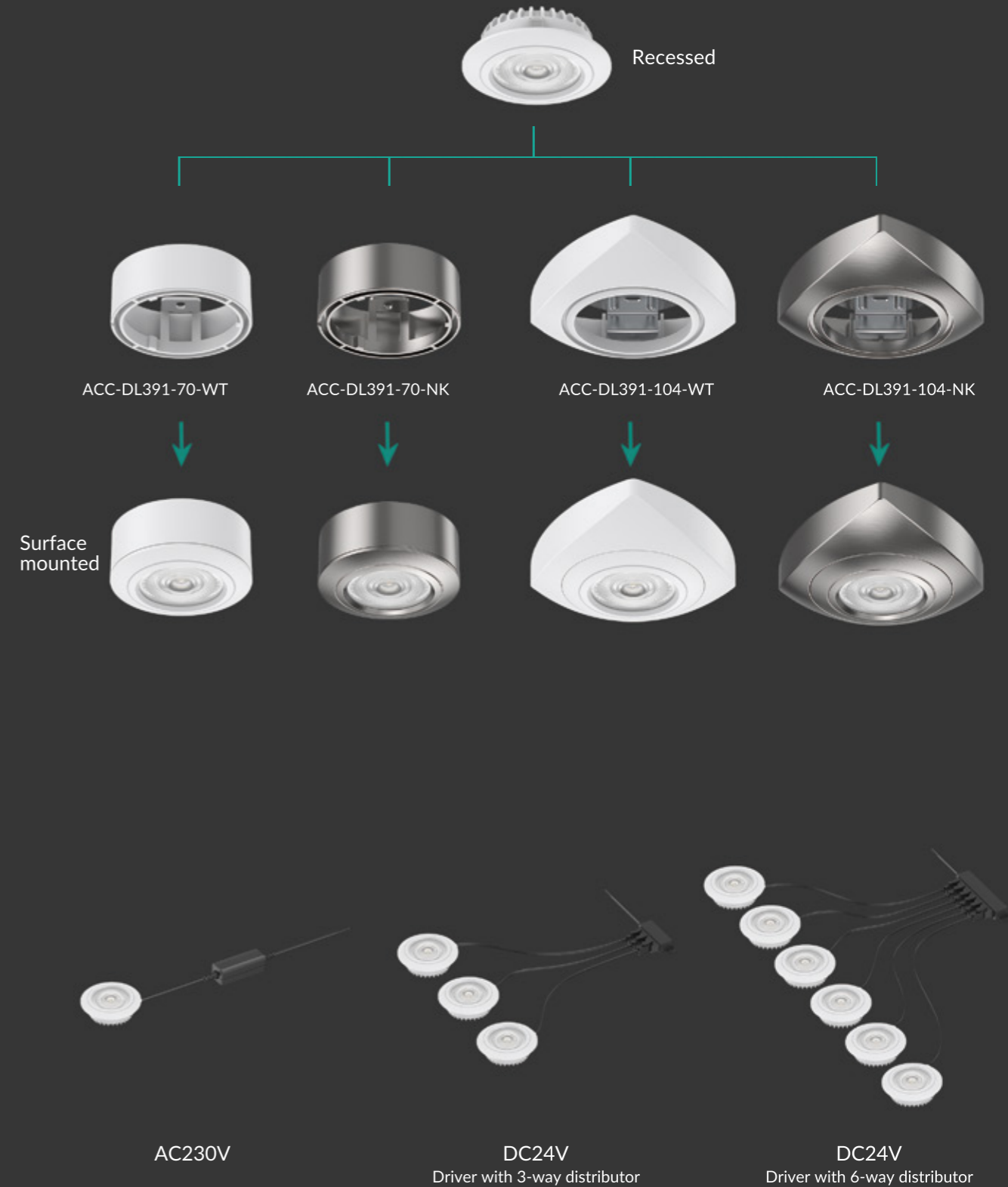

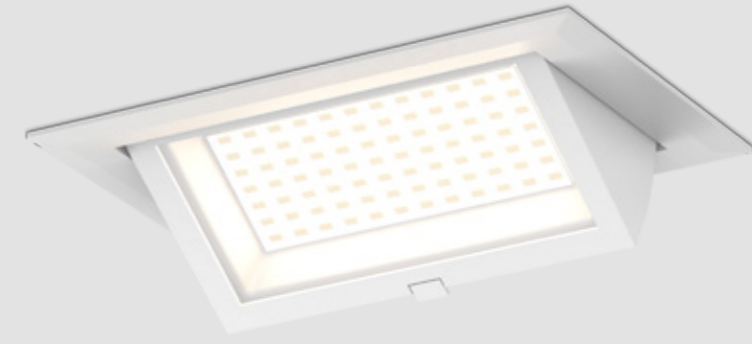

RD01 Downlight

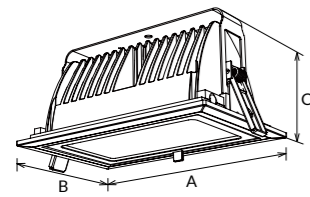

RD01 rectangular downlight is unique designed with COB high power LED chip. IP65 waterproof can be used in wider applications, especial for damp location. AL6063 Aluminum profile provides excellent thermal dissipation. Isolated external driver solution achieves stable working performance.

- 120°
- 45°
- IP65
- DIM
- DALI
- 0-10V
- Flicker Free
- AC 100-240V
- PF≥0.9
- CRI≥80
- SAA
- RoHS
- CE

Code	Watt	Size(AxBxCmm)	Cut-out(mm)	Lumen(±5%)	N.W/pc(kgs)	Q'ty/CTN
RD01-35W	35W	235x145x117.4	220x130	3950lm	2.40	6PCS
RD01-45W	45W	235x145x117.4	220x130	4700lm	2.40	6PCS

RD01-C Downlight

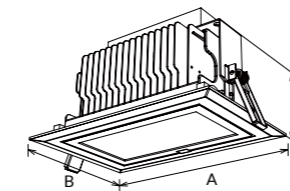

RD01-C SMD Rectangular downlight achieves high lumen output, 90° wide beam angle. AL6063 Aluminum profile provides excellent thermal dissipation. External driver solution achieves stable working performance and easy maintenance. Tilt head provides various lighting direction for different applications. It is widely used for different commercial lighting situation.

- 90°
- 65°
- IP20
- DIM
- DALI
- 0-10V
- Flicker Free
- SLIDE SWITCH 3 in 1
- AC 200-240V
- PF≥0.9
- CRI≥80
- SAA
- RoHS
- CE

Code	Watt	Size(AxBxCmm)	Cut-out(mm)	Lumen(±5%)	N.W/pc(kgs)	Q'ty/CTN
RD01-C-40W	40W	246x156x115	225x130	3950lm	2.30	4PCS
RD01-C-40W-C3	40W	246x156x115	225x130	4400lm	2.30	4PCS
RD01-C-60W	60W	246x156x115	225x130	5450lm	2.30	4PCS
RD01-C-60W-C3	60W	246x156x115	225x130	6900lm	2.30	4PCS



CL137 Downlight

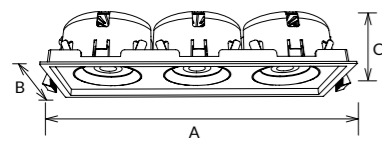

CL137 LED commercial downlight series with external flicker free driver design, adopting brand Citizen COB, ADC12 aluminium lamp body provide great heat dissipation. Tilt 23° in all directions(360°) and IP54 are available. White/Black/Silver 3 kinds of surface colors for options. Modular design as Reflector type and lens type.

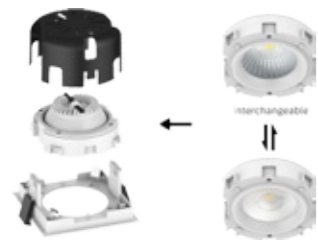

- ▶ 15° 24° 36° 60° 360°
- ▶ 23° IP20 IP54
- ▶ DIM Flicker Free
- ▶ AC 220-240V PF≥0.9 CRI≥80 CRI≥90 CRI≥97
- ▶ SAA RoHS CE

Code	Watt	Size(AxBxCmm)	Cut-out(mm)	Lumen(±5%)	N.W/pc(kgs)	Q'ty/CTN
CL137-8W	8W	95x95x53	89x89	920lm	0.35	24PCS
CL137-10W	10W	95x95x53	89x89	1100lm	0.35	24PCS
CL137-14W	14W	175x95x53	69x89	1670lm	0.60	24PCS
CL137-20W	20W	175x95x53	69x89	2230lm	0.60	24PCS
CL137-24W	24W	255x95x53	249x89	2840lm	0.85	12PCS
CL137-30W	30W	255x95x53	249x89	3320lm	0.85	12PCS

CCT — 2700K 3000K 4000K 5000K

Finish — White Black Silver

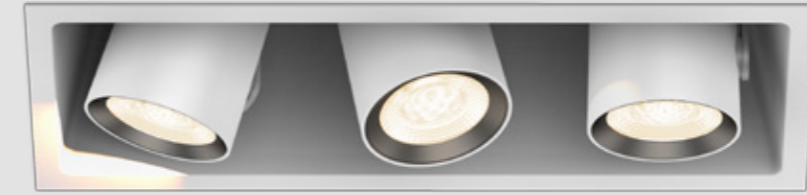

CL146 Downlight

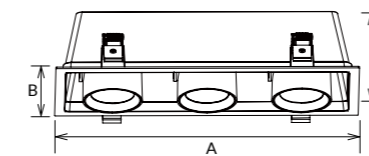

CL146 is gyro design commercial LED downlight with single/ double/ triple head options. It is tiltable 45° in all directions. SMD with 1CCT/ 3CCT, COB LED light source is available.

- ▶ 15° 24° 36° 45° 60° IP20
- ▶ DIM Flicker Free SLIDE SWITCH 3 IN 1
- ▶ AC 220-240V PF≥0.9 CRI≥80
- ▶ SAA RoHS CE

Code	Watt	Size(AxBxCmm)	Cut-out(mm)	Lumen(±5%)	N.W/pc(kgs)	Q'ty/CTN
CL146A-15W(COB)	15W	125x125x88	115x115	1800lm	0.63	12PCS
CL146A-30W(COB)	30W	228x125x88	218x115	3500lm	0.95	12PCS
CL146A-45W(COB)	45W	331x125x88	321x115	5200lm	1.32	6PCS
CL146B-8W(SMD)	8W	125x125x88	115x115	1100lm	0.63	12PCS
CL146B-16W(SMD)	16W	228x125x88	218x115	1700lm	0.95	12PCS
CL146B-24W(SMD)	24W	331x125x88	321x115	2600lm	1.32	6PCS
CL146B-8W(SMD)	8W	125x125x88	115x115	1000lm	0.63	12PCS
CL146B-16W(SMD)	16W	228x125x88	218x115	1600lm	0.95	12PCS
CL146B-24W(SMD)	24W	331x125x88	321x115	2500lm	1.32	6PCS

CCT — 2700K 3000K 4000K 5000K

Trim — White Black



CL99 Downlight

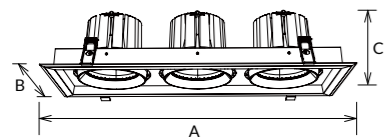

CL99 downlight is a unique replaceable module design which makes an easier installation and maintenance. The drivers are separated and external for replacement easily. It is an ideal design for commercial lighting.

- ▶ 15° 24° 36° 340° IP20
- ▶ DIM DALI 0-10V Flicker Free
- ▶ AC 200-240V PF≥0.9 CRI≥80 CRI≥90 CRI≥97
- ▶ SAA RoHS CE

Code	Watt	Size(AxBxCmm)	Cut-out(mm)	Lumen(±5%)	N.W/pc(kgs)	Q'ty/CTN
CL99-30W	30W	175x175x110	160-160	3100lm	1.25	12PCS
CL99-60W	60W	330x175x110	310-160	5800lm	2.25	6PCS
CL99-90W	90W	475x175x110	455-160	8800lm	3.20	6PCS

CCT ——— 2700K 3000K 4000K 5000K

Finish ——— White Black

Focusing lighting



LED Downlight
COB Series



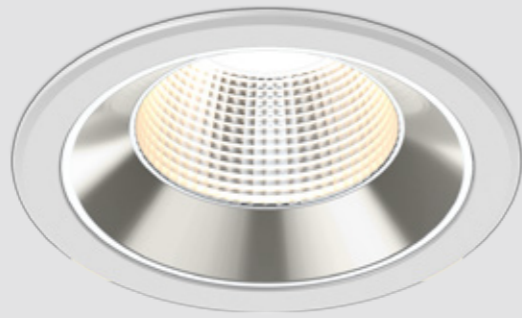

DL264 Downlight

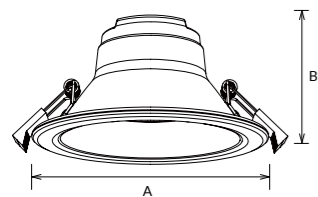

DL264 LED downlight with anti-glare UGR<19 and external driver design. Adopting high lumen SMD light source 100lm/W, the scale PC shade and reflector make a uniform light output. AL1060 aluminum housing provides a great thermal management. Interchangeable CCT and IP54 in front are available.

- ▶
- ▶
- ▶
- ▶

Code	Watt	Size(AxBmm)	Cut-out(mm)	Lumen(±5%)	N.W/pc(kgs)	Q'ty/CTN
DL264-3-10W	10W	Ø115x67mm	Ø90-95mm	950lm	0.21	30PCS
DL264-3-13W	13W	Ø115x67mm	Ø90-95mm	1200lm	0.21	30PCS
DL264-4-13W	13W	Ø145x73mm	Ø120-130mm	1200lm	0.26	24PCS
DL264-4-18W	18W	Ø145x73mm	Ø120-130mm	1500lm	0.26	24PCS
DL264-5-13W	13W	Ø170x86mm	Ø140-150mm	1350lm	0.31	24PCS
DL264-5-18W	18W	Ø170x86mm	Ø140-150mm	1850lm	0.31	24PCS
DL264-5-25W	25W	Ø170x86mm	Ø140-150mm	2650lm	0.31	24PCS
DL264-6-18W	18W	Ø190x90mm	Ø160-170mm	1850lm	0.36	12PCS
DL264-6-25W	25W	Ø190x90mm	Ø160-170mm	2650lm	0.36	12PCS
DL264-6-30W	30W	Ø190x90mm	Ø160-170mm	3150lm	0.36	12PCS
DL264-8-18W	18W	Ø235x100mm	Ø200-210mm	1850lm	0.52	12PCS
DL264-8-25W	25W	Ø235x100mm	Ø200-210mm	2650lm	0.52	12PCS
DL264-8-35W	35W	Ø235x100mm	Ø200-210mm	3600lm	0.52	12PCS

CCT — 3000K 4000K 5000K 5700K

Trim — White Black



UGR19 DEEP REFLECTOR
3CCT SMD Downlight-DL264

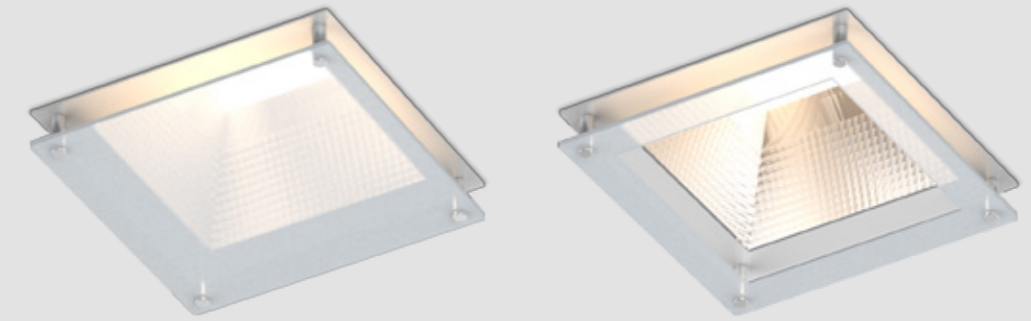
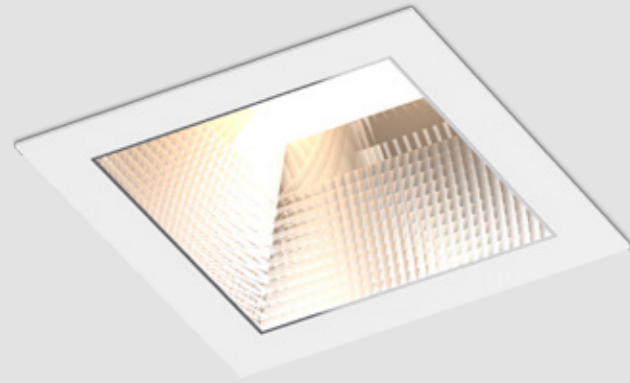

DL197 Downlight

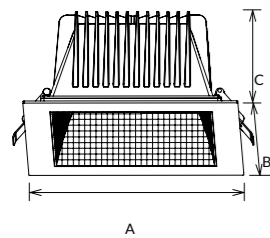

DL197 SMD LED downlight is a square-trim LED downlight for accenting and comfortable lighting. Designed with a traditional deep reflector, the luminaire offers enhanced glare control(UGR<19). ADC12 Aluminum profile provides excellent thermal dissipation. IP44 waterproof in front for various application.

-
-
-
-
-
-
-
-
-
-
-
-
-
-
-
-

Code	Watt	Size(AxBxCmm)	Cut-out(mm)	Lumen(±5%)	N.W/pc(kgs)	Q'ty/CTN
DL197-6-18W	18W	190x190x102	170x170	1760lm	1.02	8PCS
DL197-6-22W	22W	190x190x102	170x170	2120lm	1.02	8PCS
DL197-6-25W	25W	190x190x102	170x170	2420lm	1.02	8PCS
DL197-6-32W	32W	190x190x102	170x170	3070lm	1.02	8PCS

CCT 3000K 4000K 5000K 5700K

Trim White Black

DL197 Downlight Drop-glass

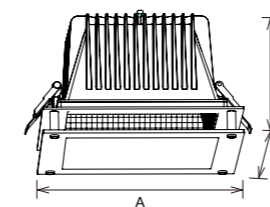

DL197 deep reflector downlight with decorative frosted glass ring and frosted glass cover options. It provides a softer light output and back light effect. The decorative glass ring or frame are very easy to disassemble. The light effect of the glass cover will be 12% lower than standard cover.

-
-
-
-
-
-
-
-
-
-
-
-
-
-
-

Code	Watt	Size(AxBxCmm)	Cut-out(mm)	Lumen(±5%)	N.W/pc(kgs)	Q'ty/CTN
DL197-6-18W	18W	190x190x127 (Drop glass)	170x170	1400lm	1.73	6PCS
DL197-6-22W	22W	190x190x127 (Drop glass)	170x170	1869lm	1.73	6PCS
DL197-6-25W	25W	190x190x127 (Drop glass)	170x170	2165lm	1.73	6PCS
DL197-6-32W	32W	190x190x127 (Drop glass)	170x170	2833lm	1.73	6PCS

CCT 3000K 4000K 5000K 5700K

Trim White Black



DL178 Downlight

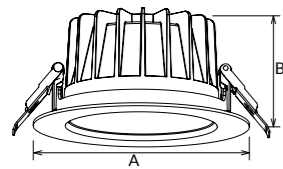

DL178 downlight with deep-set reflector provides better glaring control(UGR<19).The luminaire with modular design offers a wide choice of beam angles, 24°/36°/60°for optional. Adopted COB CITIZEN brand to reach high efficiency 110lm/W and energy saving. The luminaire blends harmoniously into ceilings, making it ideal for commercial and residential applications.

Reflector



- ▶
- ▶
- ▶
- ▶



Code	Watt	Size(AxBmm)	Cut-out(mm)	Lumen(±5%)	N.W/pc(kgs)	Q'ty/CTN
DL178A-3-10W	10W	Ø95x54	Ø82-88	1120lm	0.23	36PCS
DL178B-3-10W	10W	Ø110x54	Ø90-95	1120lm	0.27	36PCS
DL178B-3-13W	13W	Ø110x54	Ø90-95	1300lm	0.27	36PCS
DL178-4-10W	10W	Ø145x78	Ø125-135	1150lm	0.48	18PCS
DL178-4-18W	18W	Ø145x78	Ø125-135	2250lm	0.48	18PCS
DL178-4-25W	25W	Ø145x78	Ø125-135	2750lm	0.48	18PCS
DL178-6-18W	18W	Ø172x90	Ø150-165	2200lm	0.71	12PCS
DL178-6-25W	25W	Ø172x90	Ø150-165	2850lm	0.71	12PCS
DL178-6-35W	35W	Ø172x90	Ø150-165	3670lm	0.71	12PCS
DL178-8-18W	18W	Ø228x99	Ø200-210	2070lm	1.14	12PCS
DL178-8-25W	25W	Ø228x99	Ø200-210	2850lm	1.14	12PCS
DL178-8-35W	35W	Ø228x99	Ø200-210	4000lm	1.14	12PCS

CCT — 2700K 3000K 4000K 5000K

Trim — White Black

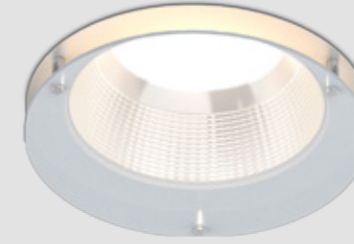

DL178 Downlight Drop-glass

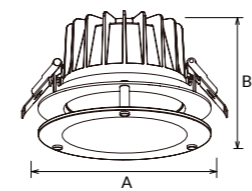

DL178 deep reflector downlight with decorative frosted glass ring and frosted glass cover options.It provides a softer light output and back light effect. The decorative glass ring or frame are very easy to disassemble. The light effect of the glass cover will be 12~18% lower than standard cover.

Reflector



- ▶
- ▶
- ▶
- ▶



Code	Watt	Size(AxBmm)	Cut-out(mm)	Lumen(±5%)	N.W/pc(kgs)	Q'ty/CTN
DL178-4-10W	10W	Ø145x97	Ø125-135	1012lm	1.05	18PCS
DL178-4-18W	18W	Ø145x97	Ø125-135	1980lm	1.05	18PCS
DL178-4-25W	25W	Ø145x97	Ø125-135	2420lm	1.05	18PCS
DL178-6-18W	18W	Ø172x109	Ø150-165	1936lm	1.30	12PCS
DL178-6-25W	25W	Ø172x109	Ø150-165	2508lm	1.30	12PCS
DL178-6-35W	35W	Ø172x109	Ø150-165	3230lm	1.30	12PCS
DL178-8-18W	18W	Ø228x118	Ø200-210	1822lm	1.84	6PCS
DL178-8-25W	25W	Ø228x118	Ø200-210	2508lm	1.84	6PCS
DL178-8-35W	35W	Ø228x118	Ø200-210	3520lm	1.84	6PCS

CCT — 2700K 3000K 4000K 5000K

Trim — White Black



DL179 Downlight

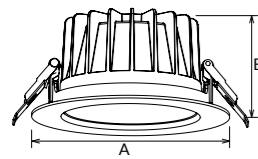

DL179 SMD LED downlight, designed with a traditional deep reflector and die-casting housing, provides perfect and comfortable lighting and excellent thermal dissipation. External driver solution both in dimmable and non-dimmable version achieves great dimming compatibility with world brand dimmers.

Reflector



- IP20 IP54 80°
- DIM DALI 0-10V Flicker Free TUNABLE WHITE SLIDE SWITCH 3 in 1
- CASAMBI
- AC 200-240V PF≥0.9 CRI≥80
- SAA RoHS CE CB

Code	Watt	Size(AxBmm)	Cut-out(mm)	Lumen(±5%)	N.W/pc(kgs)	Q'ty/CTN
DL179A-3-10W	10W	Ø95x54	Ø82-88	830lm	0.23	36PCS
DL179A-3-10W	10W	Ø95x54	Ø82-88	1030lm	0.23	36PCS
DL179B-3-10W	10W	Ø110x54	Ø90-95	870lm	0.27	36PCS
DL179B-3-10W	10W	Ø110x54	Ø90-95	1040lm	0.27	36PCS
DL179B-3-13W	13W	Ø110x54	Ø90-95	1140lm	0.27	36PCS
DL179-4-10W	10W	Ø145x78	Ø125-135	900lm	0.46	18PCS
DL179-4-12W	12W	Ø145x78	Ø125-135	1390lm	0.46	18PCS
DL179-4-18W	18W	Ø145x78	Ø125-135	1950lm	0.46	18PCS
DL179-4-25W	25W	Ø145x78	Ø125-135	2250lm	0.46	18PCS
DL179-6-18W	18W	Ø172x90	Ø150-165	1900lm	0.67	12PCS
DL179-6-18W	18W	Ø172x90	Ø150-165	2250lm	0.67	12PCS
DL179-6-25W	25W	Ø172x90	Ø150-165	2650lm	0.67	12PCS
DL179-6-35W	35W	Ø172x90	Ø150-165	3180lm	0.67	12PCS
DL179-8-18W	18W	Ø228x99	Ø200-210	2070lm	1.08	12PCS
DL179-8-25W	25W	Ø228x99	Ø200-210	2800lm	1.08	12PCS
DL179-8-25W	25W	Ø228x99	Ø200-210	3000lm	1.08	12PCS
DL179-8-35W/40W/45W	35W/40W/45W	Ø228x99	Ø200-210	4000lm/4400lm/4950lm	1.08	12PCS

CCT: 3000K 4000K 5000K 5700K Trim: White Black



DL179 Downlight Drop-glass

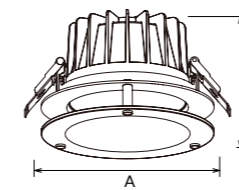

DL179 deep reflector downlight with decorative frosted glass ring and frosted glass cover options. It provides a softer light output and back light effect. The decorative glass ring or frame are very easy to disassemble. The light effect of the glass cover will be 12~18% lower than standard cover.

Reflector



- IP20 IP54 80°
- DIM DALI 0-10V Flicker Free TUNABLE WHITE SLIDE SWITCH 3 in 1
- CASAMBI
- AC 200-240V PF≥0.9 CRI≥80
- SAA RoHS CE

Code	Watt	Size(AxBmm)	Cut-out(mm)	Lumen(±5%)	N.W/pc(kgs)	Q'ty/CTN
-4-10W	10W	145x97	Ø125-135	900lm	1.05	18PCS
DL179-4-18W	18W	145x97	Ø125-135	1950lm	1.05	18PCS
DL179-4-25W	25W	145x97	Ø125-135	2250lm	1.05	18PCS
DL179-6-18W	18W	172x109	Ø150-165	1900lm	1.30	12PCS
DL179-6-25W	25W	172x109	Ø150-165	2650lm	1.30	12PCS
DL179-6-35W	35W	172x109	Ø150-165	3180lm	1.30	12PCS
DL179-8-18W	18W	228x118	Ø200-210	2070lm	1.84	6PCS
DL179-8-25W	25W	228x118	Ø200-210	2800lm	1.84	6PCS
DL179-8-35W	35W	228x118	Ø200-210	4000lm	1.84	6PCS
DL179-8-40W	40W	228x118	Ø200-210	4400lm	1.84	6PCS
DL179-8-45W	45W	228x118	Ø200-210	4950lm	1.84	6PCS

CCT: 3000K 4000K 5000K 5700K Trim: White Black



DL361 Downlight

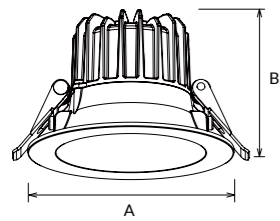

DL361 Led downlight is a deep reflector design, it has a wider shielding angle which can lower the glare and reach UGR<19. Adopt bridgelux brand COB light source, CRI>90 for a more real lighting effect. It adopts ADC12 aluminum housing to assure a better thermal management, great light transmittance with transparent tempered glass.

-
-
-
-

Code	Watt	Size(AxBmm)	Cut-out(mm)	Lumen(±5%)	N.W/pc(kgs)	Q'ty/CTN
DL361-2.5-7W	7W	Ø85xH56	Ø68-75	630lm	0.20	48PCS
DL361-3-10W NEW	10W	Ø110xH75	Ø90-100	1100lm	0.30	48PCS
DL361-4-13W NEW	13W	Ø150xH97	Ø120-130	1400lm	0.44	24PCS
DL361-4-18W	18W	Ø150xH97	Ø120-130	1770lm	0.44	24PCS
DL361-5-18W NEW	18W	Ø170xH112	Ø140-150	2020lm	0.61	24PCS
DL361-5-25W	25W	Ø170xH112	Ø140-150	2700lm	0.61	24PCS
DL361-6-18W NEW	18W	Ø190xH120	Ø160-170	2020lm	0.70	12PCS
DL361-6-25W NEW	25W	Ø190xH120	Ø160-170	2700lm	0.70	12PCS
DL361-6-30W	30W	Ø190xH120	Ø160-170	3000lm	0.70	12PCS
DL361-8-18W NEW	18W	Ø240xH142	Ø195-230	2020lm	0.93	6PCS
DL361-8-25W NEW	25W	Ø240xH142	Ø195-230	2700lm	0.93	6PCS
DL361-8-35W NEW	35W	Ø240xH142	Ø195-230	3400lm	0.93	6PCS
DL361-8-40W	40W	Ø240xH142	Ø195-230	4080lm	0.93	6PCS

CCT ——— 2700K 3000K 4000K 5000K

Trim ——— White Black



DL361 Series
UGR<19

VISIBLE BRIGHTNESS, INVISIBLE LIGHT SOURCE



DL268A



DL268B

DL268 Downlight

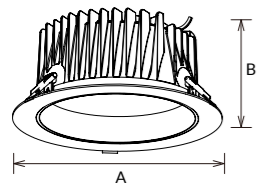

DL268 LED downlight is a traditional design with deep reflector, adopting high lumen SMD LED, providing a perfect combination of high lighting efficiency and comfortable lighting. Standard frame and invisible frame for option, complete size from 2.5inch to 10inch. UGR<19 for option, CCT changeable function is available. IP54 waterproof for room side.

- ▶
- ▶
-
- ▶
- ▶

Code	Watt	Size(AxBmm)	Cut-out(mm)	Lumen(±5%)	N.W/pc(kgs)	Q'ty/CTN
DL268-2.5-8W	8W	Ø95x55	Ø82-88	700lm	0.27	36PCS
DL268-3-10W	10W	Ø108x55	Ø90-95	800lm	0.29	36PCS
DL268-4-10W	10W	Ø145x77	Ø125-135	1100lm	0.58	18PCS
DL268-4-18W	18W	Ø145x77	Ø125-135	1900lm	0.58	18PCS
DL268-6-18W	18W	Ø172x90	Ø150-165	1900lm	0.69	12PCS
DL268-6-25W	25W	Ø172x90	Ø150-165	2800lm	0.69	12PCS
DL268-8-18W	18W	Ø228x107	Ø200-210	2000lm	1.13	12PCS
DL268-8-25W	25W	Ø228x107	Ø200-210	3000lm	1.13	12PCS
DL268-8-35W	35W	Ø228x107	Ø200-210	4000lm	1.13	12PCS
DL268-8-40W	40W	Ø228x107	Ø200-210	4300lm	1.13	12PCS
DL268-10-35W	35W	Ø280x123	Ø230-260	4100lm	1.55	6PCS
DL268-10-45W	45W	Ø280x123	Ø230-260	5000lm	1.55	6PCS
DL268-10-50W	50W	Ø280x123	Ø230-260	5300lm	1.55	6PCS

CCT ——— 3000K 4000K 5000K 5700K

Trim ——— White Black

UGR<19 ANTL-GLARE

LED Downlight-DL268

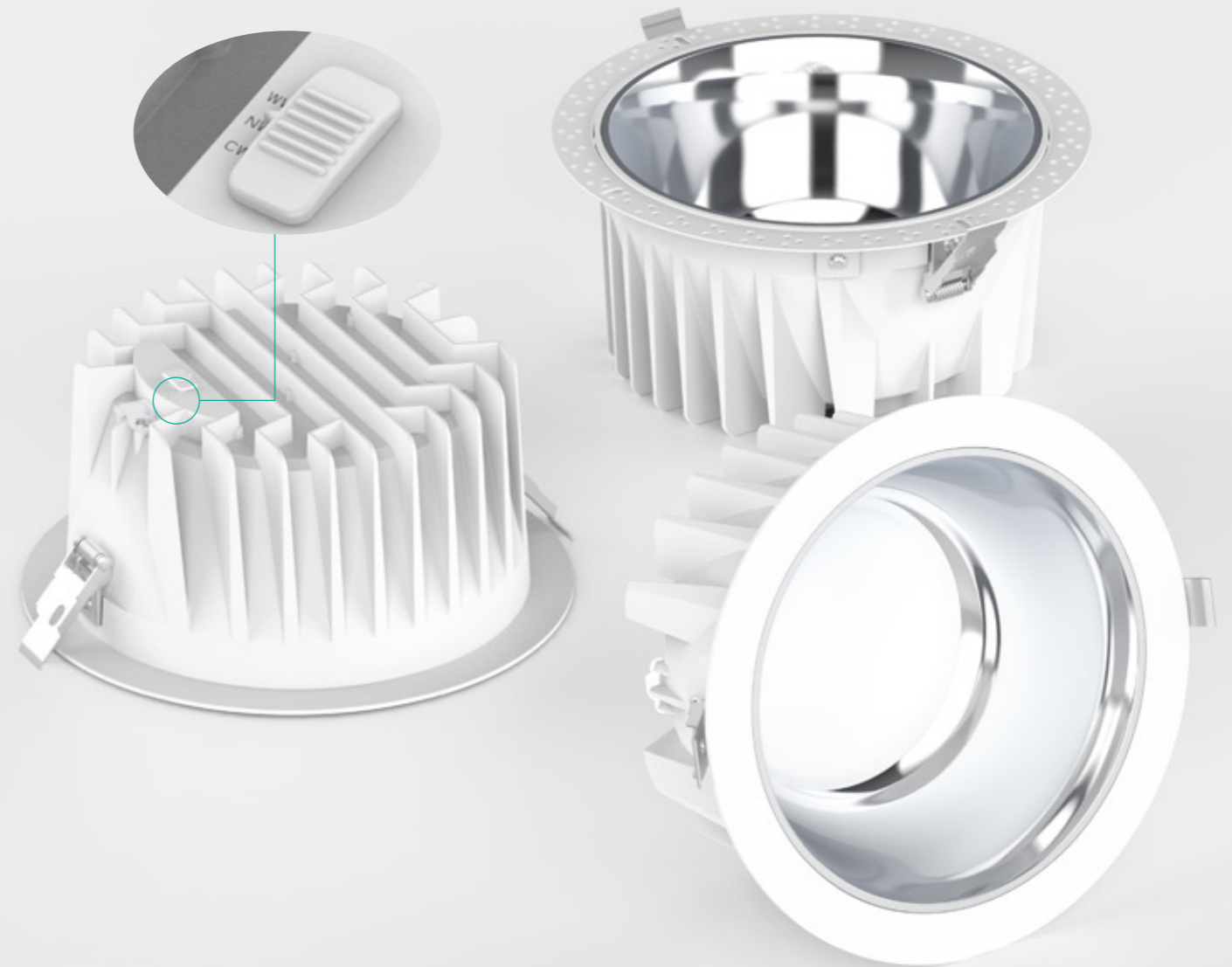



DL315 Downlight

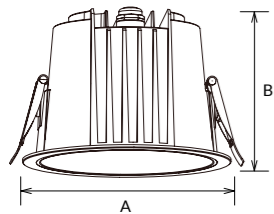

DL315 deep reflector downlight which adopts high lumen efficiency SMD 100lm/W, ADC12 Aluminum offers a great thermal management. Three covers for option, honeycomb cover and tri-reflector cover make a low UGR. Adapter ring makes a wider application area and convenient installation. IP54 in front and tri-color changeable are available.

- ▶ IP20
IP54
- ▶ DIM Flicker Free
- ▶ AC 200-240V PF ≥ 0.9 CRI ≥ 80
- ▶ SAA RoHS CE



Code	Watt	Size(AxBmm)	Cut-out(mm)	Lumen(±5%)	N.W/pc(kgs)	Q'ty/CTN
DL315-2.5	8W	Ø87x73	Ø68-75	760lm	0.24	24PCS
DL315-3-10W	10W	Ø110x84	Ø95-100	1000lm	0.31	18PCS
DL315-3-13W	13W	Ø110x84	Ø95-100	1200lm	0.31	18PCS
DL315-4-18W	18W	Ø135x96	Ø120-125	1850lm	0.46	18PCS
DL315-4-25W	25W	Ø135x96	Ø120-125	2350lm	0.46	18PCS
DL315-6-25W	25W	Ø160x117	Ø150-155	2850lm	0.64	12PCS
DL315-6-35W	35W	Ø160x117	Ø150-155	3850lm	0.64	12PCS
DL315-8-35W	35W	Ø186x128	Ø170-175	3800lm	0.85	6PCS
DL315-8-42W	42W	Ø186x128	Ø170-175	4400lm	0.85	6PCS

CCT ——— 3000K 4000K 5000K 5700K

Trim ——— White Black

MORE POSSIBILITIES

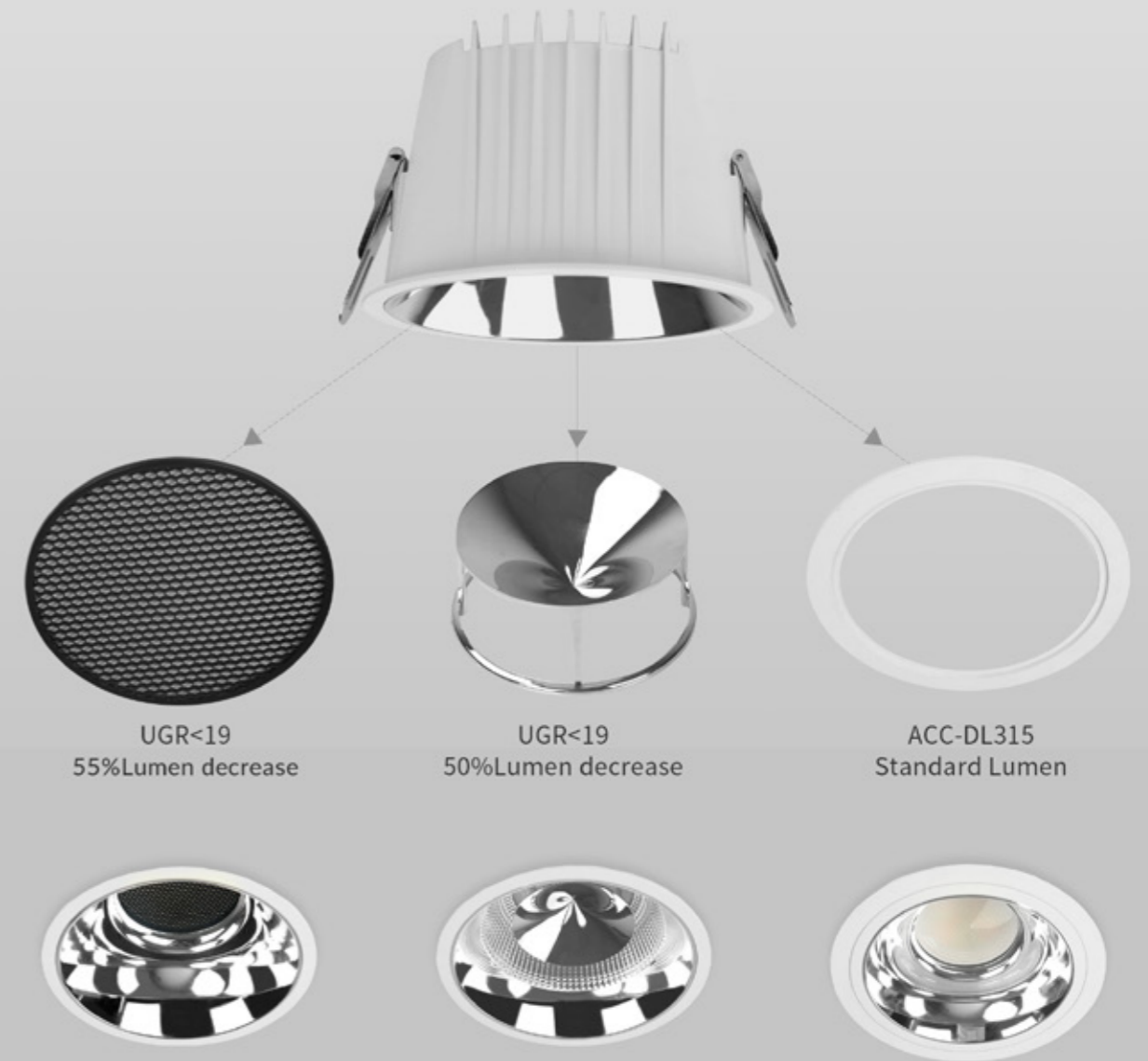

GLOWING EFFECT

GLOWING EFFECT

GLOWING EFFECT

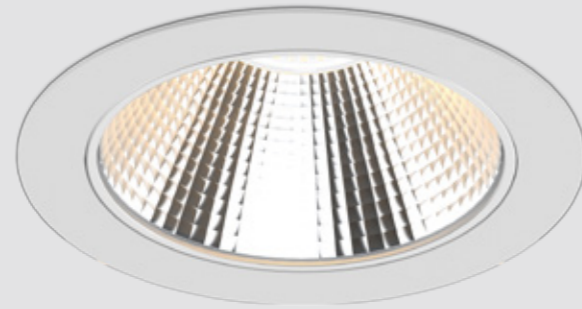

DL98A/B Downlight

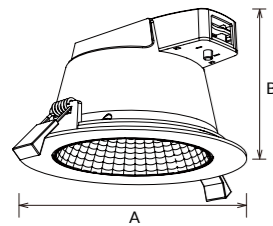

DL98 integrated SMD LED downlight series, a high-performance LED downlight for accenting and general lighting, has two reflector design optional, DL98A with faceted reflector and DL98B with specular reflector. The luminaire is easy to install with the combination of integrated driver and fast connector. Triac dimmable and 3CCT are available.

Reflector



- ▶
- ▶
- ▶
- ▶



Code	Watt	Size(AxBmm)	Cut-out(mm)	Lumen(±5%)	N.W/pc(kgs)	Q'ty/CTN
DL98-3-6W	6W	Ø110x70	Ø90-95	610lm	0.18	24PCS
DL98-4-13W	13W	Ø145x82	Ø125-135	1460lm	0.28	24PCS
DL98-6-18W	18W	Ø172x95	Ø150-165	1890lm	0.35	12PCS
DL98-8-18W	18W	Ø228x98	Ø200-210	2110lm	0.54	12PCS
DL98-8-25W	25W	Ø228x98	Ø200-210	2930lm	0.54	12PCS

CCT

Trim

DL138A/B Downlight

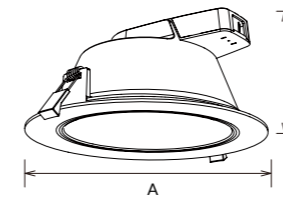

DL138 series SMD LED downlight, slide switch for color selection, is good for home and commercial project requirement. IP54 rated is available for bathrooms and other wet locations. DL98B 60° beam angle with specular reflector can reach UGR<19.

Reflector



- ▶
- ▶
- ▶
- ▶



Code	Watt	Size(AxBmm)	Cut-out(mm)	Lumen(±5%)	N.W/pc(kgs)	Q'ty/CTN
DL138-3-6W	6W	Ø110x70	Ø90-95	560lm	0.24	24PCS
DL138-4-13W	13W	Ø145x82	Ø125-135	1390lm	0.34	24PCS
DL138-6-18W	18W	Ø172x95	Ø150-165	1780lm	0.45	12PCS
DL138-8-18W	18W	Ø228x98	Ø200-210	2110lm	0.65	12PCS
DL138-8-25W	25W	Ø228x98	Ø200-210	2880lm	0.65	12PCS

CCT

Trim

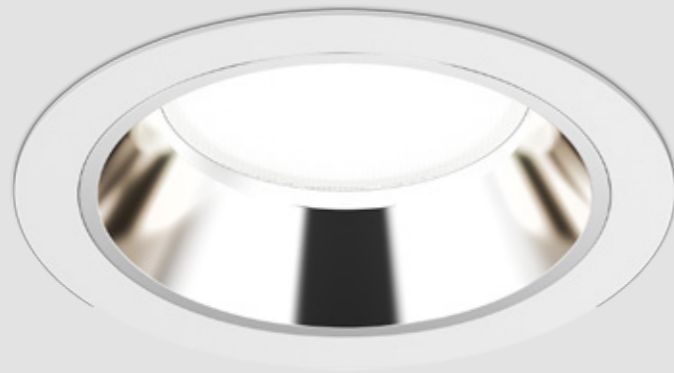

DL83 Downlight

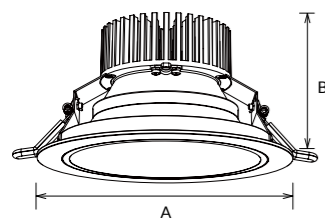

DL83 SMD downlight, a high-performance LED downlight for accenting and general lighting. Designed with a micro prism diffuser, the luminaire provides enhanced glare control and leading performance, making it ideal for commercial and residential environments. ADC12 Aluminum profile design guarantee long lifespan.

- ▶ 60° IP20 UGR<19
- ▶ DIM DALI 0-10V Flicker Free
- ▶ AC 200-240V PF≥0.9 CRI≥80
- ▶ SAA RoHS CE



Code	Watt	Size(AxBmm)	Cut-out(mm)	Lumen(±5%)	N.W/pc(kgs)	Q'ty/CTN
DL83-3-13W	13W	Ø110x80	Ø90-100	1160lm	0.33	30PCS
DL83-6-25W	25W	Ø190x100	Ø160-180	2620lm	0.76	12PCS
DL83-8-35W	35W	Ø230x110	Ø200-220	3700lm	0.98	12PCS

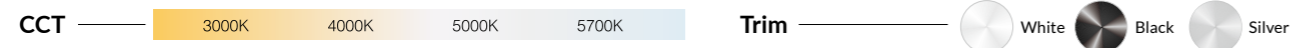

CL94 Downlight

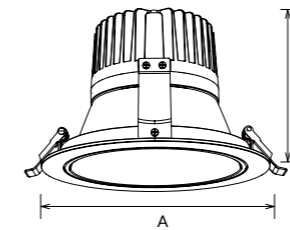

CL94 LED downlight designed with a deep reflector, provides optimal glare control(UGR<19). It adopts brand CITIZEN COB for uniform and accenting lighting. Ideal for commercial and residential applications looking for a clean, minimalist look.

- ▶ 36° 45° IP20 UGR<19
- ▶ DIM DALI 0-10V Flicker Free
- ▶ AC 200-240V PF≥0.9 CRI≥80 CRI≥90 CRI≥97
- ▶ SAA RoHS CE



Code	Watt	Size(AxBmm)	Cut-out(mm)	Lumen(±5%)	N.W/pc(kgs)	Q'ty/CTN
CL94-3-13W	13W	Ø110x100	Ø95-100	920lm	0.38	24PCS
CL94-6-25W	25W	Ø190x127	Ø165-180	2550lm	0.85	12PCS
CL94-8-35W	35W	Ø230x140	Ø205-220	3350lm	1.20	12PCS

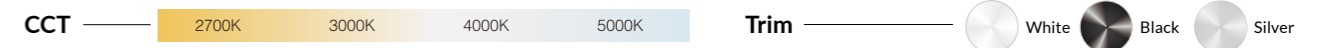



DL386A

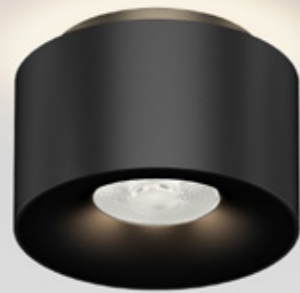

DL386B



DL386C

DL386 NEW Downlight

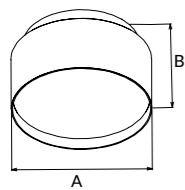

DL386 LED downlight, type A is surface mounted design, type B/C are recessed design, adopting high lumen COB or SMD and up&down lighting performance. Aluminum profile provides excellent thermal dissipation. Interchangeable CCT with slide switch is available. UGR<19 for type C.

- ▶ 15° 24° 36° 110°
- ▶ IP20
- ▶ DIM Flicker Free SLIDE SWITCH
- ▶ AC 220-240V PF≥0.8 CRI≥80
- ▶ SAA RoHS CE

Code	Watt	Size(AxBmm)	Cut-out(mm)	Lumen(±5%)	N.W/pc(kgs)	Q'ty/CTN
DL386A-90-8W	6W+2W	Ø90x94	-	850lm	0.40	12PCS
DL386B-90-11W	8W+3W	Ø90x86	Ø50-60	1100lm	0.42	12PCS
DL386C-90-10W	7W+3W	Ø90x86	Ø50-60	800lm	0.40	12PCS
DL386A-115-12W	10W+2W	Ø115x94	-	1400lm	0.54	12PCS
DL386B-115-13W	10W+3W	Ø115x105	Ø50-80	1300lm	0.58	12PCS
DL386C-115-13W	10W+3W	Ø115x105	Ø50-80	1000lm	0.55	12PCS
DL386A-140-20W	18W+2W	Ø140x79	-	2400lm	0.70	12PCS
DL386B-140-18W	15W+3W	Ø140x110	Ø50-105	1800lm	0.81	12PCS
DL386C-140-20W	17W+3W	Ø140x98	Ø50-105	1600lm	0.70	12PCS

CCT ——— 2700K 3000K 4000K 5000K 5700K Trim ——— White Black

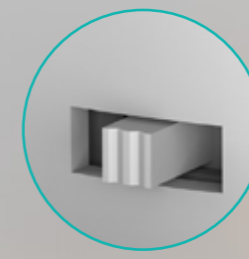

CCT changeable



DL386A
Surface mounted



DL386B
Recessed



DL386C
Recessed

Surface mounted
UP&DOWN lighting



DL38B Downlight

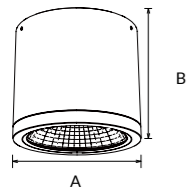

DL38B surface mounted downlight is a high-performance LED luminaire that can simultaneously or individually offer uniform and excellent light. It offers a wide choice of beam angles 24°/36°/45°/60° for optional. AL6063 Aluminum body with oxidation treatment provides excellent heat dissipation performance. DALI and 3-CCT changeable are available.

- ▶ 24° 36° 45° 60°
- ▶ IP54
- ▶ DIM DALI Flicker Free SLIDE SWITCH 3 in 1
- ▶ AC 200-240V PF≥0.9 CRI≥80
- ▶ SAA RoHS CE

Code	Watt	Size(AxBmm)	Lumen(±5%)	N.W/pc(kgs)	Q'ty/CTN
DL38B-10W	10W	Ø90x100	1000lm	0.45	24PCS
DL38B-15W	15W	Ø90x100	1350lm	0.50	24PCS
DL38B-20W	20W	Ø120x110	2400lm	0.52	18PCS
DL38B-25W	25W	Ø120x110	2950lm	0.65	18PCS
DL38B-10W-DA	10W	Ø120x110	1500lm	0.52	18PCS
DL38B-15W-DA	15W	Ø120x110	1850lm	0.52	18PCS
DL38B-20W-DA	20W	Ø120x110	2400lm	0.52	18PCS
DL38B-25W-DA	25W	Ø120x110	2950lm	0.65	12PCS
DL38B-25W	25W	Ø160x120	3300lm	1.23	12PCS
DL38B-32W	32W	Ø160x120	3680lm	1.50	12PCS
DL38B-25W-DA	25W	Ø160x120	3300lm	1.23	12PCS
DL38B-32W-DA	32W	Ø160x120	3680lm	1.50	12PCS
DL38B-10W-C3 NEW	10W	Ø90x100	700lm	1.50	12PCS
DL38B-15W-C3 NEW	15W	Ø120x110	1600lm	1.23	12PCS
DL38B-25W-C3 NEW	25W	Ø160x120	2700lm	1.50	12PCS

CCT ——— 2700K 3000K 4000K 5000K

Trim ——— White Black

DL38B Series



LED Downlight
Surface mounted &
Pendant Series

Interchangeable CCT

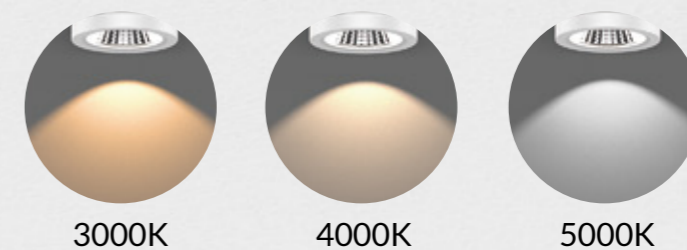



DL328 Downlight

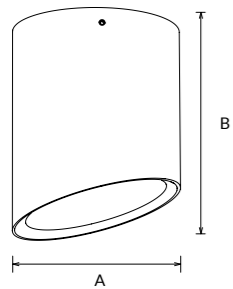

DL328 Surface mounted downlight shape comes from a cone. It adopts COB light source and reflector polarized design to reach a uniform wall washing effect and lower the glare. The ADC12 aluminum housing and transparent glass have a good corrosion resistance and thermal management so that can ensure a long lifespan. No need to adjust angle to reach wall washing effect, integrated polarized design keeps both professional level and high cost performance.

- ▶ 70° 30° IP20
- ▶ DIM Flicker Free
- ▶ AC 220-240V PF≥0.9 CRI≥80
- ▶ SAA RoHS CE

Code	Watt	Size(AxBmm)	Lumen(±5%)	N.W/pc(kgs)	Q'ty/CTN
DL328-3-10W	10W	Ø90x113	1000lm	0.26	24PCS
DL328-4-18W	18W	Ø120x142	1950lm	0.39	12PCS
DL328-4-25W	25W	Ø120x142	2700lm	0.39	12PCS

CCT — 2700K 3000K 4000K 5000K

Finish — White Black



DL176 Downlight

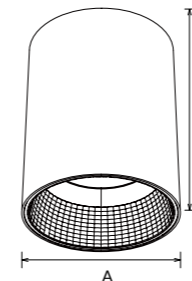

DL176 downlight with deep-set reflector provides better glaring control(UGR<19). It offers a wide choice of outputs, beam angles and color rendering options. Surface mounted down light with no-screw outside fixation provide a much cleaner out-looking design. Built-in driver, easy for installation.

- ▶ 24° 36° 60° IP54 UGR<19
- ▶ DIM DALI Flicker Free
- ▶ AC 200-240V PF≥0.9 CRI≥80 CRI≥90 CRI≥97
- ▶ SAA RoHS CE CB

Code	Watt	Size(AxBmm)	Lumen(±5%)	N.W/pc(kgs)	Q'ty/CTN
DL176-15W	15W	Ø100x134	1750lm	0.65	18PCS
DL176-25W	25W	Ø120x144	2800lm	0.84	12PCS
DL176-35W	35W	Ø170x159	3900lm	1.45	6PCS

CCT — 2700K 3000K 4000K 5000K

Finish — White Black Wood grain



DL269 Downlight

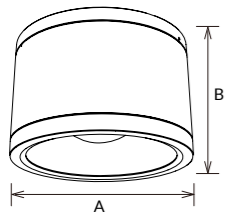

DL269 series downlight as IP65 waterproof design is widely used for indoor and semi-outdoor environment. DL269A as COB and DL269B as SMD with flicker free driver, 3 CCT switchable. DL269A UGR<19, DL269B UGR<25. Tempered Glass in front as IK06

- ▶ 24° 36° 60° 70° 75°
- ▶ IP65 IK06 UGR<19 UGR<25
- ▶ Flicker Free SIDE SWITCH 3 in 1
- ▶ AC 200-240V PF≥0.9 CRI≥80
- ▶ SAA RoHS CE CB

Code	Watt	Size(AxBmm)	Lumen(±5%)	N.W/pc(kgs)	Q'ty/CTN
DL269A/B-3-10W	10W	Ø90x107	1100lm	0.60	18PCS
DL269A/B-3-15W	15W	Ø90x107	1600lm	0.60	18PCS
DL269A/B-5-18W	18W	Ø130x115	1900lm	0.92	12PCS
DL269A/B-5-25W	25W	Ø130x115	2500lm	0.92	12PCS
DL269A/B-6-25W	25W	Ø160x110	2500lm	1.18	6PCS
DL269A/B-6-30W	30W	Ø160x110	3000lm	1.18	6PCS
DL269A/B-8-25W	25W	Ø214x119	2500lm	2.20	6PCS
DL269A/B-8-35W	35W	Ø214x119	3500lm	2.20	6PCS
DL269A/B-10-35W	35W	Ø250x125	3500lm	2.80	4PCS
DL269A/B-10-40W	40W	Ø250x125	4200lm	2.80	4PCS
DL269A/B-10-45W	45W	Ø250x125	4600lm	2.80	4PCS

CCT — 2700K 3000K 4000K 5000K 5700K

Finish — White Black

IP65 IK06 Downlight

DL269B SMD (70°)

DL269A COB (24°/36°/60°)

Tempered glass

Fast connector



DL129 Downlight

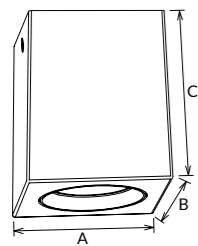

DL129 square surface mounted downlight adopts brand CITIZEN Bridgelux, COB and high reflective (more than 88%) for accenting and general lighting. Adjustable lighting direction, 350° in horizontal and 25° in vertical. The luminaire offers a choice of beam angles, color rendering options, making it ideal for commercial, and residential environments. 3-CCT interchangeable is available.

-
-
-
-

Code	Watt	Size(AxBxCmm)	Lumen(±5%)	N.W/pc(kgs)	Q'ty/CTN
DL129-90-6W	6W	90x90x110	630lm	0.60	24PCS
DL129-90-10W	10W	90x90x110	1030lm	0.60	24PCS
DL129-115-16W	16W	115x115x122	2350lm	0.90	18PCS

CCT ——— 2700K 3000K 4000K 5000K Finish ——— White Black Silver



DL130 Downlight

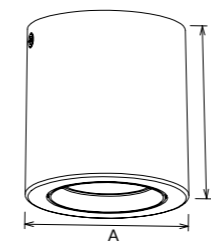

DL130 round surface mounted downlight adopts brand CITIZEN Bridgelux, COB and high reflective (more than 88%) for accenting and general lighting. Adjustable lighting direction, 350° in horizontal and 25° in vertical. The luminaire offers a choice of beam angles, color rendering options, making it ideal for commercial, and residential environments. 3-CCT interchangeable is available.

-
-
-
-

Code	Watt	Size(AxBmm)	Lumen(±5%)	N.W/pc(kgs)	Q'ty/CTN
DL130-90-6W	6W	Ø90x110	630lm	0.55	24PCS
DL130-90-10W	10W	Ø90x110	1030lm	0.55	24PCS
DL130-115-16W	16W	Ø115x122	2350lm	0.83	18PCS

CCT ——— 2700K 3000K 4000K 5000K Finish ——— White Black Silver



DL244 Downlight

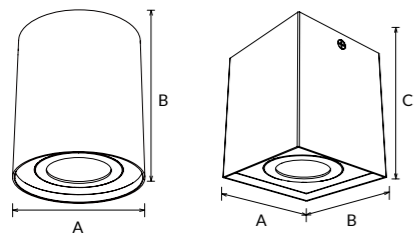

DL244 surface mounted downlight, adopting high lumen COB 100lm/W, ADC12 heat sink and multi-layer structure provide excellent thermal dissipation. Built-in driver solution both in dim and Non-dim version achieves great dimming compatibility with the worldwide brand dimmers. 360° in horizontal and 23° in vertical and IP54 are available.

- ▶ 15° 24° 36° 60° 360°
- ▶ 23° IP54
- ▶ DIM Flicker Free
- ▶ AC 200-240V CRI ≥ 80
- ▶ SAA RoHS CE

Code	Watt	Size(AxBxCmm)	Lumen(±5%)	N.W/pc(kgs)	Q'ty/CTN
DL244-90-6W	6W	Ø90x108	730lm	0.44	24PCS
DL244-90-10W	10W	Ø90x108	1090lm	0.44	24PCS
DL244-90-6W	6W	90x90x108	730lm	0.52	24PCS
DL244-90-10W	10W	90x90x108	1090lm	0.52	24PCS

CCT — 2700K 3000K 4000K 5000K

Finish — White Black Silver

DL244 Series

High transmittance lens and high reflective reflector option

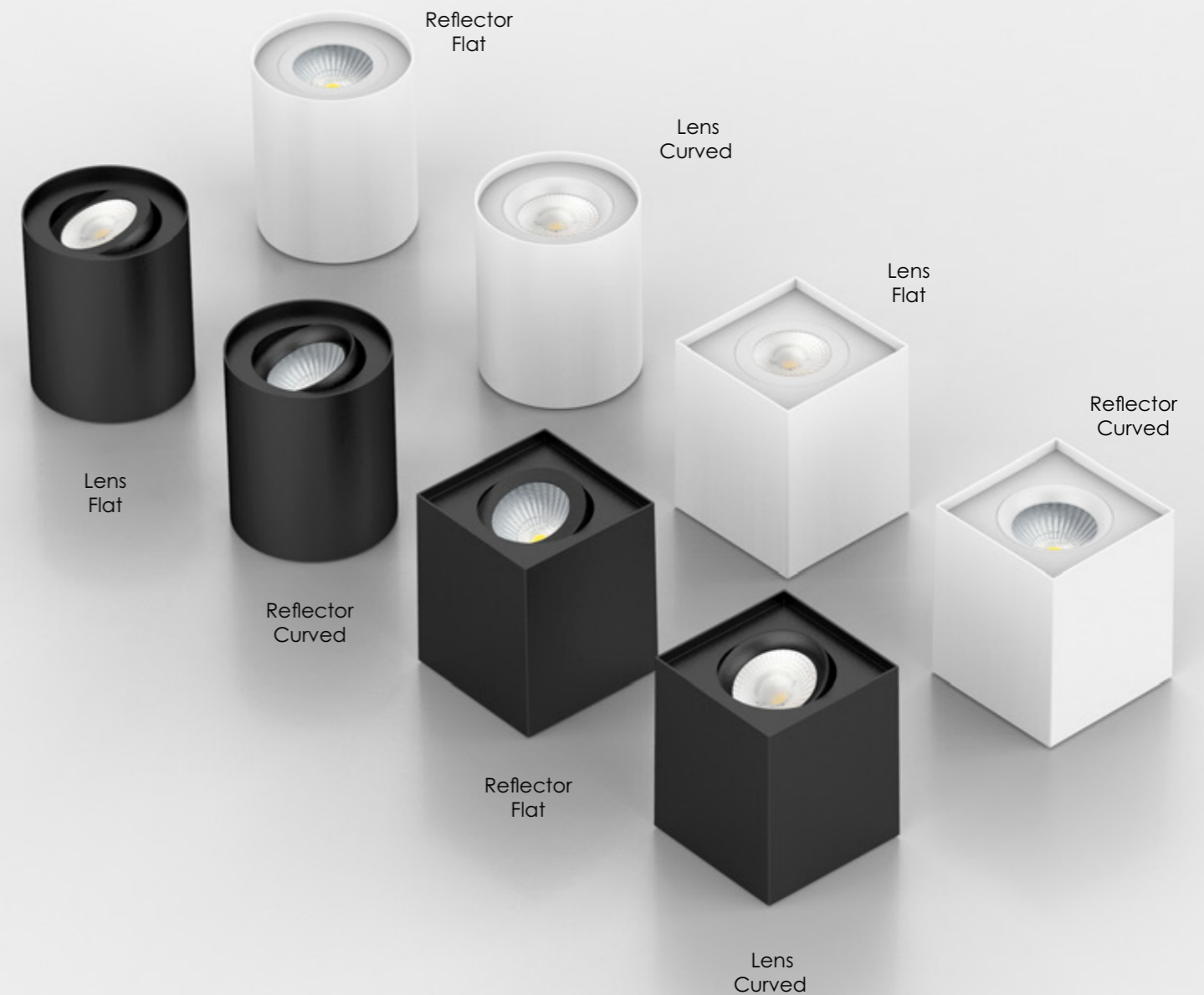

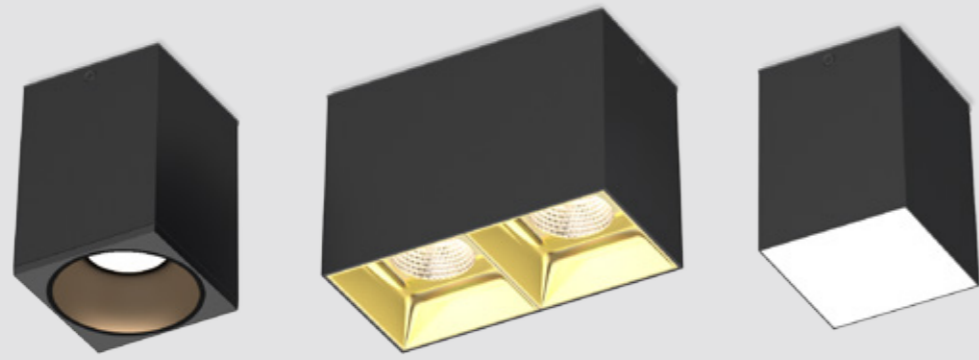

DL379A

DL379B

DL379C



DL379 NEW Downlight

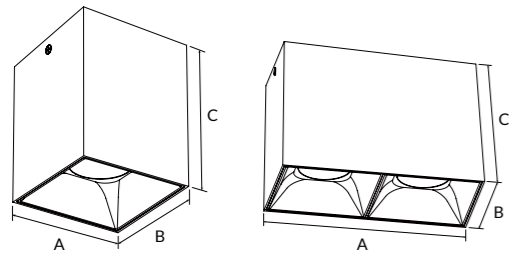

DL379 is a square shape surface downlight combined with single/ double head, white/ black finishing, black/ white/ golded reflector, round/ square head, SMD/ COB LED, single CCT/ 3 CCT multiple choice. COB type as reflector can reach UGR<19.

-
-
-
-
-

Code	Watt	Size(AxBmm)	Lumen(±5%)	N.W/pc(kgs)	Q'ty/CTN
DL379A-95-8W	8W	95x95x131	1000lm	0.6	24PCS
DL379A-95-14W	14W	95x95x131	1600lm	0.6	24PCS
DL379B-95-8W	8W	95x95x125	1000lm	0.6	24PCS
DL379B-95-14W	14W	95x95x125	1600lm	0.6	24PCS
DL379C-95-8W	8W	95x95x125	900lm	0.6	24PCS
DL379C-95-14W	14W	95x95x125	1450lm	0.6	24PCS
DL379A-185-14W	14W	185x95x131	1600lm	1.1	12PCS
DL379A-185-28W	28W	185x95x131	3300lm	1.1	12PCS
DL379B-185-14W	14W	185x95x125	1600lm	1.1	12PCS
DL379B-185-28W	28W	185x95x125	3300lm	1.1	12PCS
DL379C-185-14W	14W	185x95x125	1600lm	1.1	12PCS
DL379C-185-28W	28W	185x95x125	3150lm	1.1	12PCS

CCT — 2700K 3000K 4000K 5000K Finish — White Black Silver

DL387 NEW Downlight

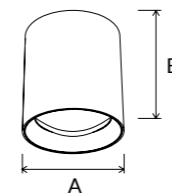

DL387 LED surfacemounted downlight with internal driver design. Aluminum profile provides excellent thermal dissipation. UGR<19 for anti-glare design. Triac dim and CCT changeable are available.

-
-
-
-
-

Code	Watt	Size(AxBmm)	Lumen(±5%)	N.W/pc(kgs)	Q'ty/CTN
DL387-90-8W	8W	∅90x100	950lm	0.47	24PCS

CCT — 2700K 3000K 4000K 5000K Finish — White Black



DL277A/B Downlight

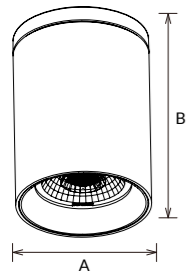

DL277A/B surface mounted downlight adopts high lumen LED chip and PC lens which make sure the high luminous, DL277A adopts COB chip with four beam angle options: 15°/24°/36°/60°, DL277B adopts SMD chip with 45°/70° beam angle options. 6063 aluminum housing provides excellent thermal dissipation. The installation is very easy, screwless design on surface gives the lamp an IP54 protection level.

- ▶ 15° 24° 36° 45°
- ▶ 60° 70°
- ▶ IP54
- ▶ DIM Flicker Free
- ▶ AC 200-240V PF≥0.9 CRI≥80 CRI≥90
- ▶ SAA RoHS CE

Code	Watt	Size(AxBmm)	Lumen(±5%)	N.W/pc(kgs)	Q'ty/CTN
DL277A - 6W	6W	Ø70x100	621lm	0.32	24PCS
DL277B - 6W	6W	Ø70x100	600lm	0.32	24PCS
DL277A-10W	10W	Ø70x100	1000lm	0.32	24PCS
DL277B-10W	10W	Ø70x100	1000lm	0.32	24PCS

CCT ——— 2700K 3000K 4000K 5000K

Finish ——— White Black



DL277C Downlight

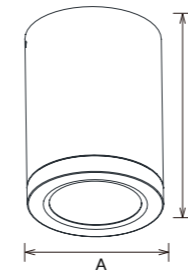

DL277C surface mounted downlight adopts high lumen LED chip and PC lens which make sure the high luminous. DL277C adopts LEDiL-RONDA lens, single asymmetric and double asymmetric 6 lens optional and replaceable, 360 degree rotation to adjust lighting direction. 6063 aluminum housing provides excellent thermal dissipation. The installation is very easy, screwless design on surface gives the lamp an IP20 protection level.

- ▶ IP20
- ▶ DIM Flicker Free
- ▶ AC 200-240V PF≥0.9 CRI≥80 CRI≥90
- ▶ SAA RoHS CE

Polarized Light Display



Code	Watt	Size(AxBmm)	Lumen(±5%)	N.W/pc(kgs)	Q'ty/CTN
DL277C-6W	6W	Ø70x102	660lm	0.33	24PCS
DL277C-10W	10W	Ø70x102	1000lm	0.33	24PCS

CCT ——— 2700K 3000K 4000K 5000K Finish ——— White Black

Interchangeable lens options





DL207 Downlight

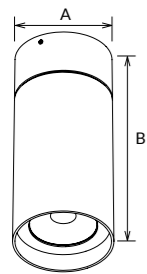

DL207 surface mounted LED downlight, with the special design of adjusting lighting orientation, 330° rotate and 90° tilt. The luminaire adopts CITIZEN brand COB, makes uniform light and excellent lumen output. Aluminum profile with sufficient heat management guarantee long lifespan.

-
-
-
-

Code	Watt	Size(AxBmm)	Lumen(±5%)	N.W/pc(kgs)	Q'ty/CTN
DL207-15W	15W	Ø85x186	1750lm	0.67	12PCS
DL207-25W	25W	Ø85x211	2900lm	0.73	12PCS

CCT — 2700K — 3000K — 4000K — 5000K

Finish — White Black

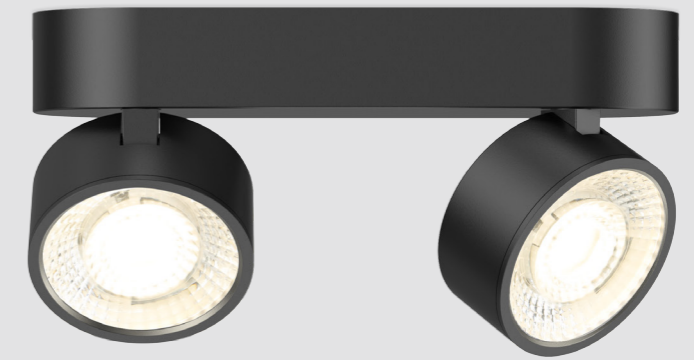

DL79 ^{NEW} Downlight

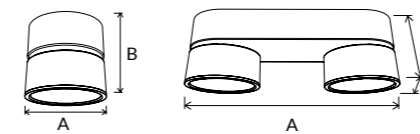

DL79(1/2/3 heads) LED downlight adopts high lumen COB reach to 120lm/W, PC lens with uniform light. Aluminum profile provides excellent thermal dissipation. Vertically 90 degree, horizontal 350 degree is available.

-
-
-
-

Code	Watt	Size(AxBxCmm)	Lumen(±5%)	N.W/pc(kgs)	Q'ty/CTN
DL79-10W	10W	Ø90x87	1200lm	0.56	12PCS
DL79-20W	20W	260x89x87	2400lm	1.29	6PCS
DL79-30W	30W	430x89x87	3580lm	1.89	4PCS

CCT — 2700K — 3000K — 4000K — 5000K

Finish — White Black



DL297B Downlight

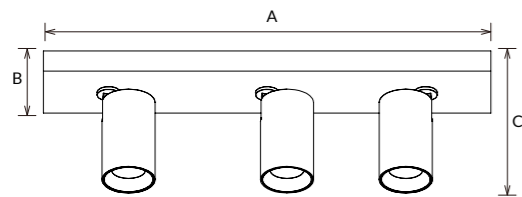

DL297B is a surface mounted COB downlight with aluminum body and cylindrical appearance design. CRI80 and CRI90 available, IP20, support non-dimmable and triac dimmable. PC Lens with 24 and 36 beam angle for options.

- ▶ 24° 36° 320° 90° IP20

- ▶ DIM Flicker Free

- ▶ AC 220-240V PF \geq 0.9 CRI \geq 80 CRI \geq 90

- ▶ SAA RoHS CE



Code	Watt	Size(AxBxCmm)	Lumen(±5%)	N.W/pc(kgs)	Q'ty/CTN
DL297B-0911-10W/14W	10W/14W	110x90x134	900lm/1250lm	0.62	24PCS
DL297B-0930-20W/28W	20W/28W	305x90x134	1800lm/2500lm	1.13	12PCS
DL297B-0948-30W/42W	30W/42W	480x90x134	2700lm/3800lm	1.58	6PCS

CCT

Trim



DL313 Downlight

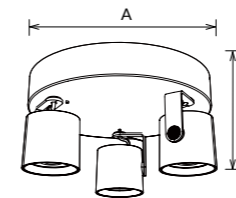
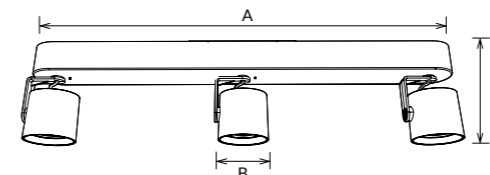

DL313 is a multiple head surface mounted downlight (2/3 heads). Screwless on surface makes it more compact and elegant, special rotatory arm for flexible lighting direction adjustment. Two types for option: Type A with COB light source, Type B with SMD light source(CCT changeable available).

- ▶ 15° 24° 36° 45° 60°

- ▶ 355° 45° IP20

- ▶ DIM Flicker Free SLIDE SWITCH 3 in 1

- ▶ AC 220-240V PF \geq 0.9 CRI \geq 80

- ▶ SAA RoHS CE



Code	Watt	Size(AxBxCmm)	Lumen(±5%)	N.W/pc(kgs)	Q'ty/CTN
DL313A/B-16W	16W	300x65x125	2300lm	0.94	12PCS
DL313A/B-24W	24W	560x65x125	3000lm	1.40	12PCS
DL313A/B-24W-R	24W	230x125	3000lm	1.47	12PCS

CCT

Finish

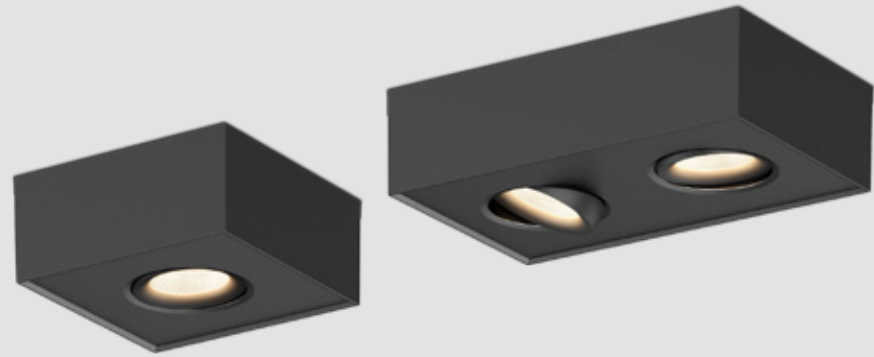

DL259 Downlight

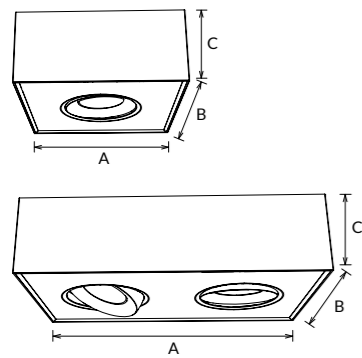

DL259 LED surface mounted downlight with flicker free built-in driver design, adopting Edison COB and aluminium lamp body which provides good heat dissipation. Dim-to-Warm version (2000K~3000K) is available. Tilt 30° in all directions(360°).

- ▶ 15° 24° 30° 36° 60°
- ▶ 360° 23° IP20
- ▶ DIM Flicker Free
- ▶ AC 200-240V PF≥0.9 CRI≥90 CRI≥97
- ▶ SAA RoHS CE

Code	Watt	Size(AxBxCmm)	Lumen(±5%)	N.W/pc(kgs)	Q'ty/CTN
DL259-8W-D	8W	135x135x60	700lm	0.58	24PCS
DL259-8W-DW	8W	135x135x60	440lm	0.58	24PCS
DL259-16W-D	16W	224x135x60	1600lm	0.91	12PCS
DL259-16W-DW	16W	224x135x60	950lm	0.91	12PCS

CCT — 2700K 3000K 4000K 5000K Finish — White Black Silver Wood grain

DL259 GYRO DESIGN SURFACE MOUNTED DOWNLIGHT

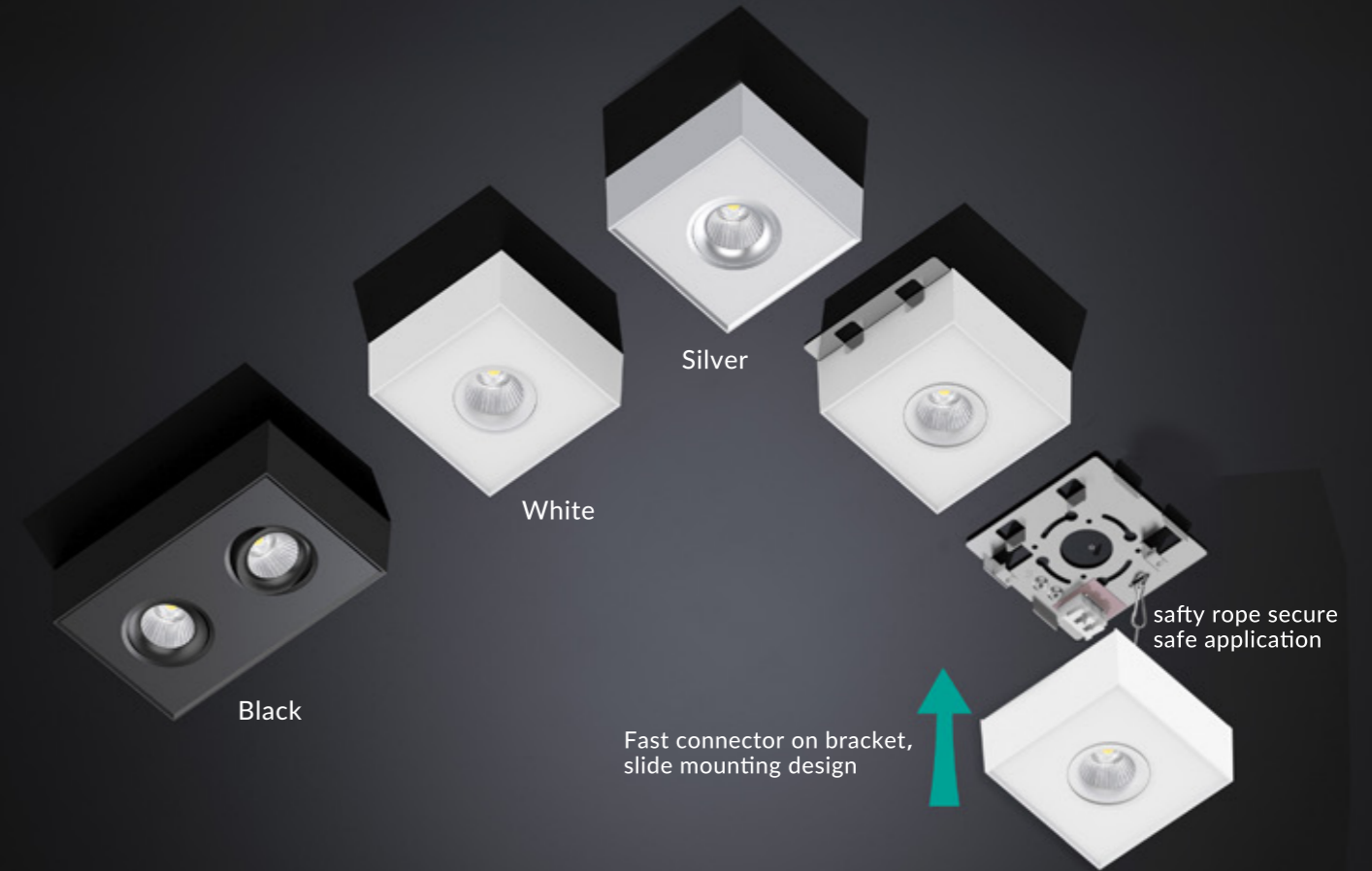

LED Downlight
Surface mounted &
Pendant Series

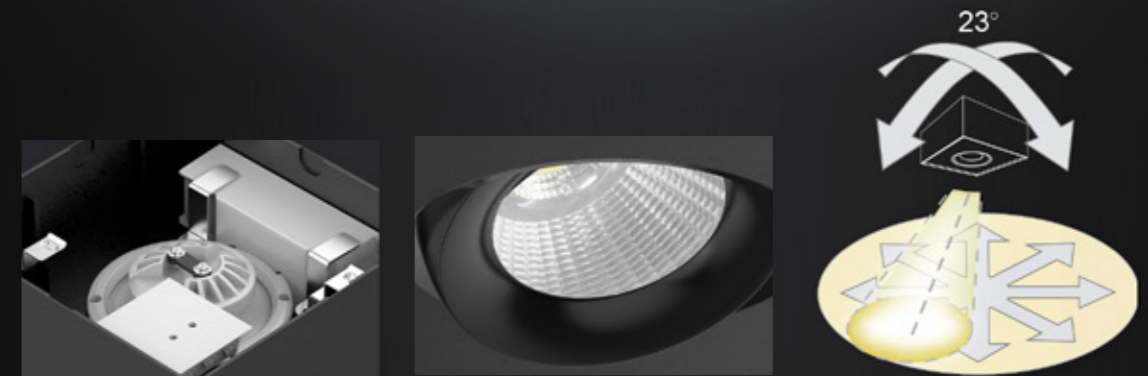



DL266S Downlight

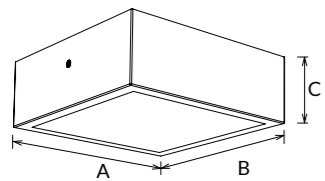

DL266S surface mounted downlight adopts 2835 SMD and PMMA LGP. The die-casting aluminum frame provides a great thermal management. The external driver design and 3 CCT interchangeable are available.

- 120°
- IP20
- DIM
- Flicker Free
- 3 in 1
- AC 200-240V
- PF ≥ 0.9
- CRI ≥ 80
- SAA
- RoHS
- CE

Code	Watt	Size(AxBxCmm)	Lumen(±5%)	N.W/pc(kgs)	Q'ty/CTN
DL266-6W-S	6W	120x120x38	420lm	0.37	36PCS
DL266-12W-S	12W	170x170x38	950lm	0.48	24PCS
DL266-18W-S	18W	224x224x38	1500lm	0.77	12PCS
DL266-24W-S	24W	300x300x38	2000lm	0.95	12PCS

CCT — 3000K 4000K 5000K 5700K 6500K — Finish — White Black



DL266R Downlight

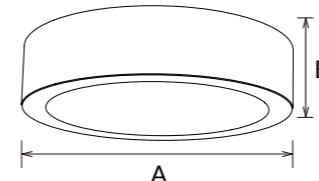

DL266R surface mounted downlight adopts 2835 SMD and PMMA LGP. The die-casting aluminum frame provides a great thermal management. The external driver design and 3 CCT interchangeable are available.

- 120°
- IP20
- DIM
- Flicker Free
- 3 in 1
- AC 200-240V
- PF ≥ 0.9
- CRI ≥ 80
- SAA
- RoHS
- CE

Code	Watt	Size(AxBmm)	Lumen(±5%)	N.W/pc(kgs)	Q'ty/CTN
DL266-6W-R	6W	Ø120x38	420lm	0.35	36PCS
DL266-12W-R	12W	Ø170x38	950lm	0.45	24PCS
DL266-18W-R	18W	Ø224x38	1500lm	0.75	12PCS
DL266-24W-R	24W	Ø300x38	2000lm	0.93	12PCS

CCT — 3000K 4000K 5000K 5700K 6500K — Finish — White Black



DL266B



DL266C

LED Downlight
Surface mounted &
Pendant Series

DL266B Downlight

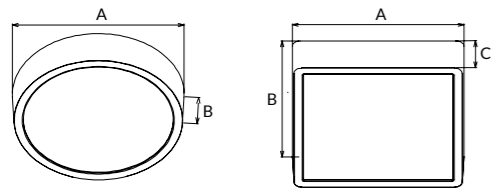

DL266B surface mounted downlight adopts 2835 SMD and PMMA LGP. Full PC lamp body provides great competitiveness in price. The external driver design and 3 CCT interchangeable are available.

- ▶ 120° IP20
- ▶ DIM Flicker Free SLIDE SWITCH 3 in 1
- ▶ AC 200-240V PF≥0.9 CRI≥80
- ▶ SAA RoHS CE

Code	Watt	Size(AxBmm)	Lumen(±5%)	N.W/pc(kgs)	Q'ty/CTN
DL266B-120-6W	6W	Ø120x45	700lm	0.187	24PCS
DL266B-160-8W	8W	Ø160x45	1000lm	0.247	24PCS
DL266B-220-18W	18W	Ø220x47	2300lm	0.411	12PCS
DL266B-300-25W	25W	Ø300x47	3600lm	0.637	6PCS
DL266C-120-6W	6W	120x120x45	700lm	0.212	24PCS
DL266C-160-8W	8W	160x160x45	1000lm	0.285	24PCS
DL266C-220-18W	18W	220x220x47	2300lm	0.477	12PCS
DL266C-300-25W	25W	300x300x47	3600lm	0.748	6PCS



DL266B/C

UP TO 140LM/W



DL115A/B Downlight

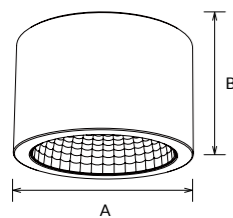

DL115A/B SMD compact and neat surface mounted downlight series with 3 CCT in 1 lamp optional, slide switch for color selection are good for commercial project requirement. An IP54-rated version for indoor use. 60° beam angle with specular reflector can reach UGR<19.

Reflector



- ▶ 60° 90° IP54 UGR<19
- ▶
- ▶ AC 100-277V AC 200-240V PF≥0.9 CRI≥80
- ▶



Code	Watt	Size(AxBmm)	Lumen(±5%)	N.W/pc(kgs)	Q'ty/CTN
DL115-4-13W	13W	Ø143x112	1460lm	0.39	12PCS
DL115-6-18W	18W	Ø170x124	1890lm	0.49	12PCS
DL115-8-25W	25W	Ø213x129	2930lm	0.80	12PCS

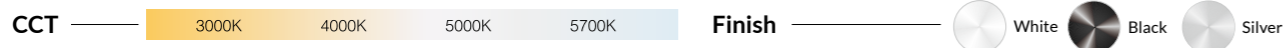

PD05A/B Pendant light

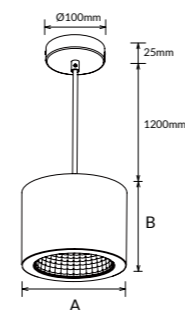

PD05A/B SMD pendant downlight series with 3 CCT in 1 lamp optional, slide switch for color selection is good for commercial project requirement. 60° beam angle with specular reflector can reach UGR<19.

Reflector



- ▶ 60° 90° IP20 UGR<19
- ▶
- ▶ AC 100-277V AC 200-240V PF≥0.9 CRI≥80
- ▶



Code	Watt	Size(AxBmm)	Lumen(±5%)	N.W/pc(kgs)	Q'ty/CTN
PD05-4-13W	13W	Ø143x110	1460lm	0.65	12PCS
PD05-6-18W	18W	Ø170x123	1890lm	0.83	12PCS
PD05-8-25W	25W	Ø213x127	2930lm	1.06	12PCS





PD02C&D Downlight/Pendant light

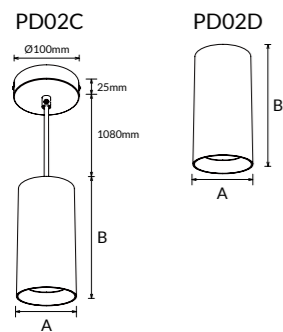

PD02C pendant spot light and PD02D surface mounted downlight with stylish appearance, making it ideal for commercial and residential applications looking for a clean, minimalist look. Adopted brand CREE COB for uniform and accenting lighting. Aluminum profile with sufficient heat management guarantee long lifespan.

- ▶ 10° 15° 24° 36°
- ▶ IP20 DIM Flicker Free
- ▶ AC 100-240V AC 200-240V PF≥0.9 CRI≥80 CRI≥90 CRI≥97
- ▶ SAA RoHS CE

Code	Watt	Size(AxBmm)	Lumen(±5%)	N.W/pc(kgs)	Q'ty/CTN
PD02C-10W	10W	Ø80x130	1230lm	0.75	24PCS
PD02C-18W	18W	Ø80x160	1970lm	0.81	24PCS
PD02C-25W	25W	Ø112.5x160	2470lm	0.95	24PCS
PD02D-10W	10W	Ø80x130	1230lm	0.50	24PCS
PD02D-18W	18W	Ø80x160	1970lm	0.56	24PCS
PD02D-25W	25W	Ø112.5x160	2470lm	0.75	24PCS

CCT ——— 2700K 3000K 4000K 5000K

Finish ——— White Black

Decoration Ring ——— White Black Other

Let you poetic life

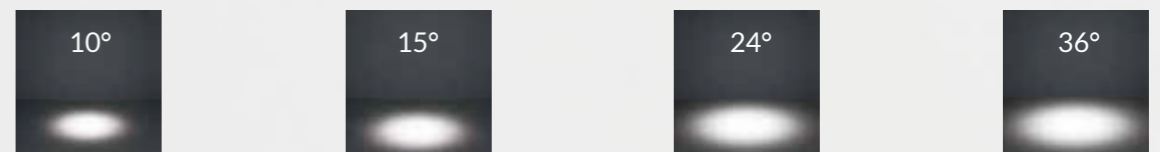

LED Downlight
Surface mounted &
Pendant Series

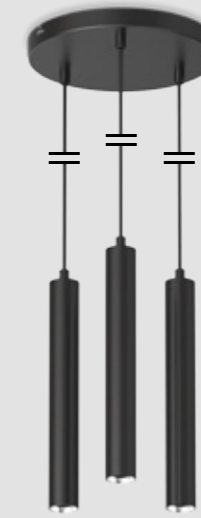
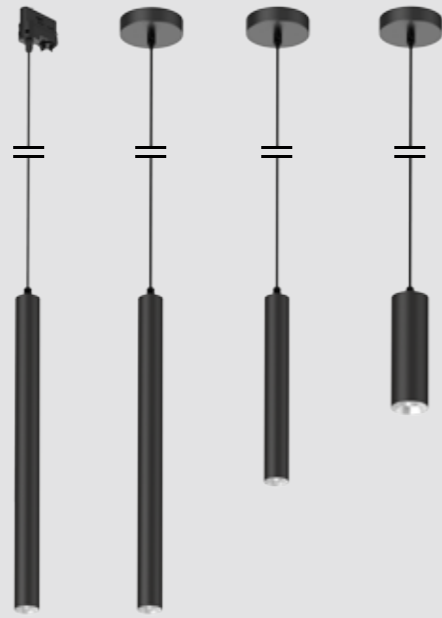

PD12 Pendant light

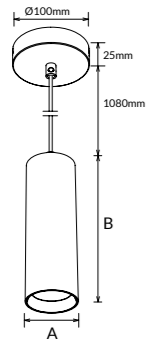

PD12 pendant spot light with slim and stylish appearance is good for home and commercial project requirement. It offers a wide choice of beam angles 15/24/36/60° for optional. Different colors of trim is optional for creating diversified light atmosphere.

- ▶ 15° 24° 36° 60°
- ▶ IP20 UGR<19
- ▶ Flicker Free
- ▶ AC 200-240V CRI≥80 CRI≥90 CRI≥97
- ▶ SAA RoHS CE

Code	Watt	Size(AxBmm)	Lumen(±5%)	N.W/pc(kgs)	Q'ty/CTN
PD12-5W	5W	Ø39x300	500lm	0.51	18PCS
PD12-5W	5W	Ø39x500	500lm	0.65	18PCS
PD12-10W	10W	Ø58x180	1000lm	0.54	12PCS

CCT — 2700K 3000K 4000K 5000K — Finish — White Black Silver

PD12B Pendant light

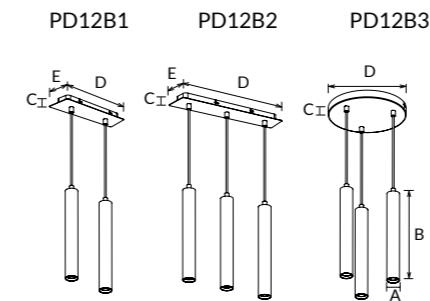

PD12B cylinder large pendant is a high-performance LED luminaire that is ideal for commercial and residential applications. It offers a wide choice of beam angles 15/24/36/60° for optional. Different colors of trim is optional for creating diversified light atmosphere.

- ▶ 15° 24° 36° 60°
- ▶ IP20 UGR<19
- ▶ Flicker Free
- ▶ AC 200-240V CRI≥80 CRI≥90 CRI≥97
- ▶ SAA RoHS CE



Code	Watt	Size(AxBxCxDxEmm)	Lumen(±5%)	N.W/pc(kgs)	Q'ty/CTN
PD12B1-10W	10W	Ø39x300x26x250x80	1100lm	1.20	6PCS
PD12B2-15W	15W	Ø39x300x26x370x80	1650lm	1.80	6PCS
PD12B3-15W	15W	Ø39x300x25xØ240	1650lm	1.80	6PCS

CCT — 2700K 3000K 4000K 5000K — Finish — White Black Silver



PD173 NEW Pendant light

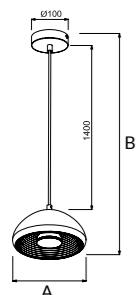

PD173 LED decorative pendant light. Crafted in electrostatic spraying way, the lamp surface is smooth and bright. Metal paint inner frame with metallic glitter texture makes it hard and has anti-ultraviolet ability. The decorative cover adopts CD pattern processing technology, which makes the whole lamp highly recognizable, aesthetic and advanced visual perception. To let you feel the right ambiance in your space, the main light source is illuminated from top, and the wavy lines of diffuse reflection creates a soft and warm atmosphere.

- ▶ 120° IP20
- ▶ DIM Flicker Free
- ▶ AC 220-240V PF≥0.85 PF≥0.9 CRI≥80
- ▶ SAA RoHS CE

Code	Watt	Size(AxBxmm)	Lumen(±5%)	N.W/pc(kgs)	Q'ty/CTN
PD173A-8-8W	8W	Ø200x1525	590lm	0.68	8PCS
PD173B-8-8W	8W	Ø200x1525	590lm	0.58	8PCS
PD173A-12-15W	15W	Ø300x1575	1210lm	1.12	2PCS
PD173B-12-15W	15W	Ø300x1575	1210lm	1.10	2PCS

CCT ——— 2700K 3000K 4000K 5000K

Finish ——— White Black Copper

Ring ——— Golden Copper White



LED Downlight
Surface mounted
Pendant Series

Main Light + Ambient Light



LED Ceiling Light & LED Bulkhead /Series/

LED ceiling light in all its forms—most of the time plays a secondary role of attention but attach great importance to the general lighting of a room. It puts your room in best lighting effect by innovative lighting solutions and design. ELWA ceiling light series has a low profile design providing a discreet, robust and stylish emergency, sensor and main luminaires.

It's with Elegantly slim and offered as both emergency and mains luminaires. It allows same seamless profile to be used throughout an installation. All options in the range are ideal for all projects when a high quality luminaire is required. Offering wide flexibility in facility lighting which is best suited to residential and commercial areas.

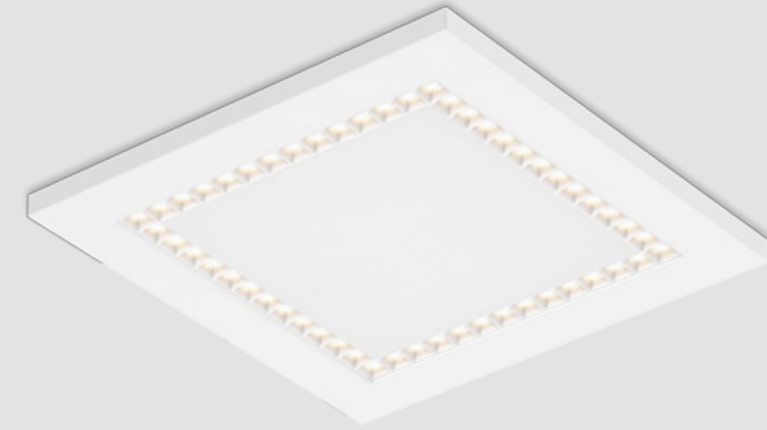

AL37 Ceiling light

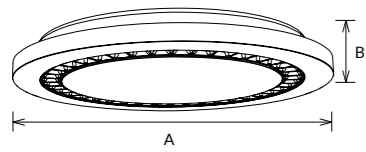

AL37 Anti-glare LED ceiling light adopts multi-louver reflectors, effectively reduces glare index(UGR) to protecting human eyes. High luminous efficiency, 94-V0 fire-rated PC material housing and fast connection terminal design make it to be widely used in various lighting applications. Microwave Sensor and Triac dimmable function are available.

- 100°
- IP40
- DIM
- Flicker Free
- ((-))
- AC 200-240V
- PF ≥ 0.9
- CRI ≥ 80
- SAA
- RoHS
- CE

Code	Watt	Size(AxBmm)	Lumen(±5%)	N.W/pc(kgs)	Q'ty/CTN
AL37-10-12W	12W	Ø250x33	1520lm	0.54	20PCS
AL37-12-15W	15W	Ø300x33	2000lm	0.80	10PCS
AL37-16-25W	25W	Ø400x33	3120lm	1.33	10PCS

CCT 3000K 4000K 5000K 5700K

Finish White

AL38 Ceiling light

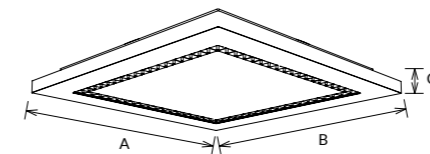

AL38 Anti-glare square ceiling light adopts multi-louver reflectors, effectively reduces glare index(UGR) to protecting human eyes. High luminous efficiency, 94-V0 fire-rated PC material housing and fast connection terminal design make it to be widely used in various lighting applications. Microwave Sensor and Triac dimmable function are available.

- 100°
- IP40
- DIM
- Flicker Free
- ((-))
- AC 200-240V
- PF ≥ 0.9
- CRI ≥ 80
- SAA
- RoHS
- CE

Code	Watt	Size(AxBxCmm)	Lumen(±5%)	N.W/pc(kgs)	Q'ty/CTN
AL38-10-12W	12W	250x250x33	1560lm	0.66	20PCS
AL38-12-15W	15W	300x300x33	1890lm	0.90	10PCS
AL38-16-25W	25W	400x400x33	3050lm	1.58	10PCS

CCT 3000K 4000K 5000K 5700K

Finish White

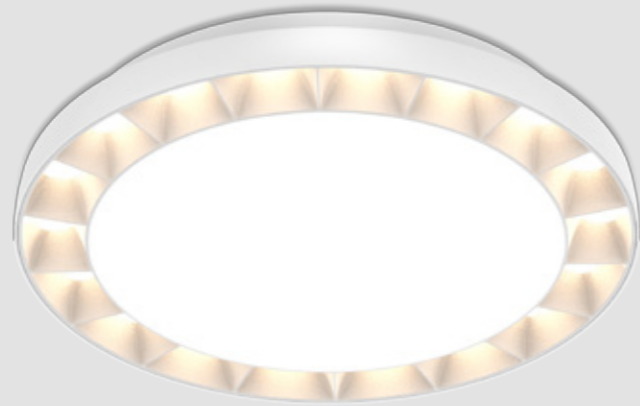

IP54 GRILL REFLECTOR REPLACEABLE

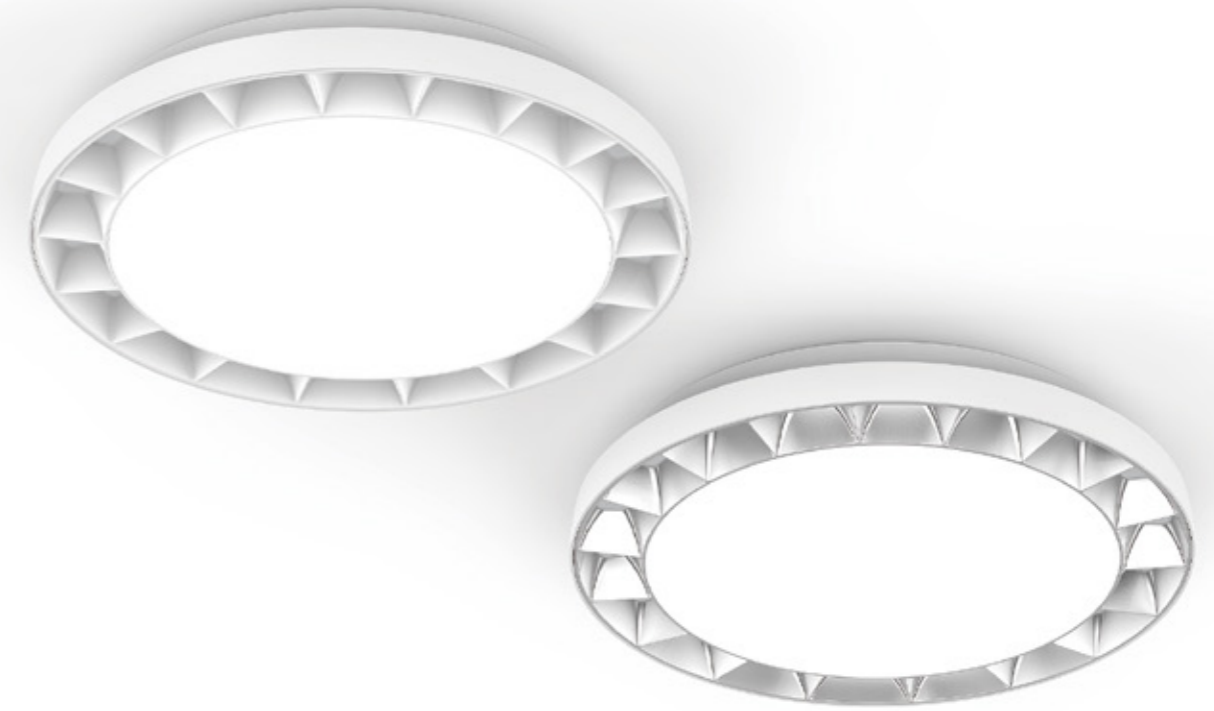

AL131 Ceiling light

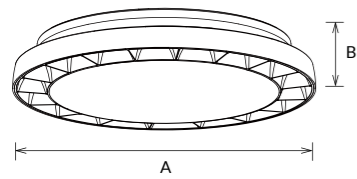

AL131 is a grille-reflector ceiling light with low glare, offering comfortable visual experience. It's the perfect combination of technology and art, suitable for modern lighting.

- ▶ 80° IP54 UGR<19
- ▶ DIM Flicker Free SLEW SWITCH 2 in 1 ((••))
- ▶ AC 220-240V PF≥0.9 CRI≥80
- ▶ SAA RoHS CE

Code	Watt	Size(AxBmm)	Lumen(±5%)	N.W/pc(kgs)	Q'ty/CTN
AL131-11-11W	11W	Ø275x48	1350lm	0.81	12PCS
AL131-11-17W	17W	Ø275x48	1900lm	0.81	12PCS
AL131-14-17W	17W	Ø350x48	1900lm	1.23	10PCS
AL131-14-24W	24W	Ø350x48	2600lm	1.23	10PCS

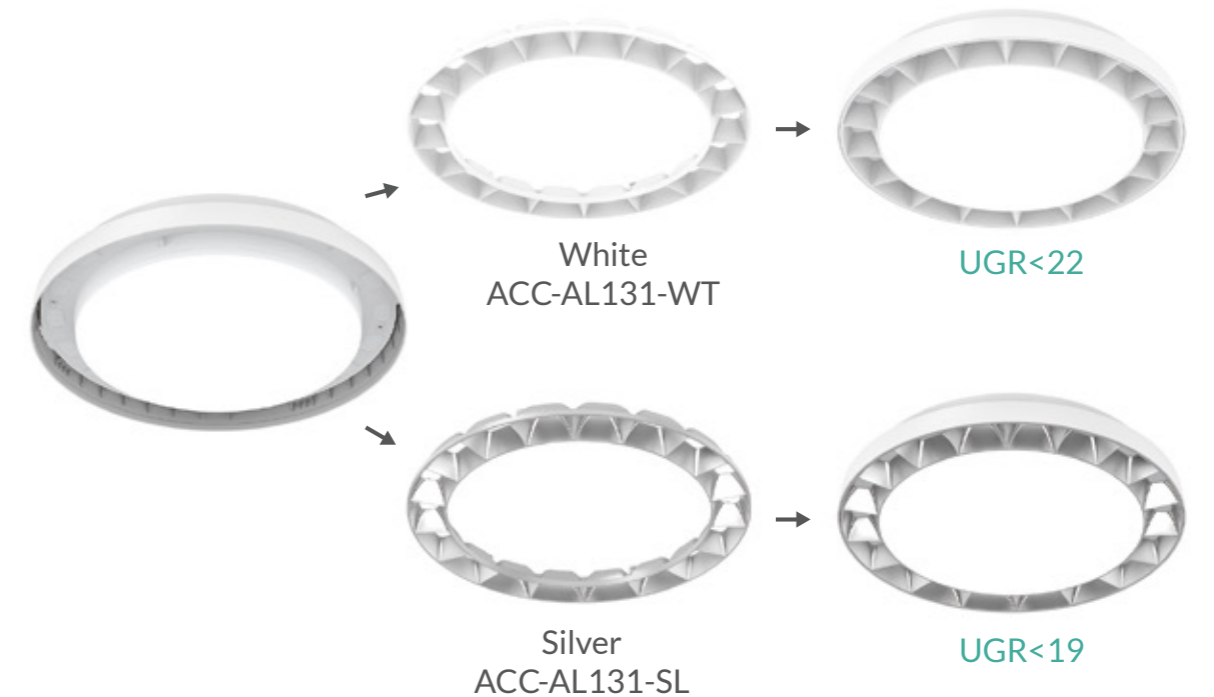

CCT 3000K 4000K

Finish White Silver



AL08B Ceiling light

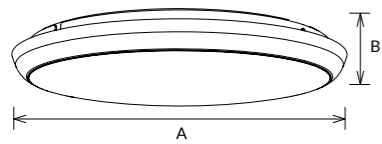

AL08B is a classical and functional ceiling light, especially in emergency, sensor, 3CCT changeable (by slide switch or remote control), triac dimmable functions etc. IP54 for non-sensor type and IP40 for sensor type. 8/10/12/14/16 inch sizes as options, It's ideal luminaire to any indoor applications.

- 120° beam angle, IP54, IP40, IK10
- DIM, Flicker Free, SLIDE SWITCH 3 in 1, Emergency, WIFI
- Bluetooth, Smart Lighting
- AC 200-240V, PF≥0.9, CRI≥80
- SAA, RoHS, CE, CB, TÜV Rheinland CERTIFIED

Code	Watt	Size(AxBmm)	Lumen(±5%)	N.W/pc(kgs)	Q'ty/CTN
AL08B-8-12W	12W	Ø200x48	1330lm	0.42	20PCS
AL08B-10-12W	12W	Ø250x48	1300lm	0.66	20PCS
AL08B-12-18W	18W	Ø300x40	2060lm	0.80	10PCS
AL08B-12-25W	25W	Ø300x40	2650lm	0.80	10PCS
AL08B-14-25W	25W	Ø350x40	2900lm	1.30	10PCS
AL08B-16-30W	30W	Ø400x52	3360lm	1.40	10PCS

CCT: 3000K, 4000K, 5000K, 5700K

Finish: White, Black, Silver

Ring: ACC-AL08 Nickel Brushed 10"-250mm / 12"-300mm



AL12B Ceiling light

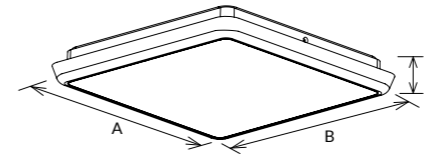

AL12B is a classical and functional square ceiling light, especially in emergency, sensor, 3CCT changeable (by slide switch or remote control), triac dimmable functions etc. IP54 for non-sensor type and IP40 for sensor type. 10/12/14/16 inch sizes as options, It's ideal luminaire to any indoor applications.

- 120° beam angle, IP54, IP40, IK10
- DIM, Flicker Free, SLIDE SWITCH 3 in 1, Emergency, WIFI
- Bluetooth, Smart Lighting
- AC 200-240V, PF≥0.9, CRI≥80
- SAA, RoHS, CE, CB, TÜV Rheinland CERTIFIED

Code	Watt	Size(AxBxCmm)	Lumen(±5%)	N.W/pc(kgs)	Q'ty/CTN
AL12B-10-12W	12W	250x250x50	1330lm	0.75	20PCS
AL12B-12-18W	18W	300x300x40	1995lm	0.96	10PCS
AL12B-12-25W	25W	300x300x40	2775lm	0.96	10PCS
AL12B-14-25W	25W	350x350x41	2775lm	1.24	10PCS
AL12B-16-30W	30W	400x400x51	3330lm	2.00	10PCS

CCT: 3000K, 4000K, 5000K, 5700K

Finish: White, Black, Silver



AL149 Ceiling light

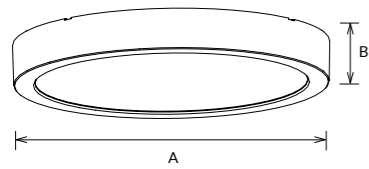

AL149 is an ultra-thin ceiling lamp. The lamp base and LED base could be separated for better installation and maintenance. Color Changeable, microwave sensor, triac dimming functions are available.

- ▶ 120° IP20
- ▶ DIM Flicker Free SLIDE SWITCH 3 in 1 ((·))
- ▶ AC 220-240V PF ≥ 0.9 CRI ≥ 80
- ▶ SAA RoHS CE

Code	Watt	Size(AxBmm)	Lumen(±5%)	N.W/pc(kgs)	Q'ty/CTN
AL149-10-12W	12W	Ø250x33	1100lm	0.70	12PCS
AL149-12-18W	18W	Ø300x33	1600lm	1.00	12PCS
AL149-16-25W	25W	Ø400x33	2150lm	1.50	6PCS

CCT ——— 3000K ——— 4000K ——— 5700K

Finish ——— White

Ring ——— ACC-AL149 Nickel Brushed ACC-AL149 Wood Grain

Installation accessories ——— ACC-AL149-WT-BK-0200



AL149B NEW Ceiling light

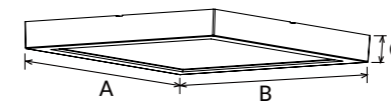

AL149B is an ultra-thin square ceiling light with 33mm thickness, adopting high lumen SMD LED, V0 fire-rated materials to ensure better heat and corrosion resistance. Interchangeable CCT and microwave sensor available.

- ▶ 110° IP20
- ▶ DIM Flicker Free SLIDE SWITCH 3 in 1 ((·))
- ▶ AC 220-240V PF ≥ 0.9 CRI ≥ 80
- ▶ SAA RoHS CE

Code	Watt	Size(AxBxCmm)	Lumen(±5%)	N.W/pc(kgs)	Q'ty/CTN
AL149B-12-15W	15W	300x300x33	1750lm	1.2	10PCS

CCT ——— 3000K ——— 4000K ——— 5000K ——— 5700K

Finish ——— White

Ring ——— ACC-AL149B-12-BK ACC-AL149B-12-WD ACC-AL149B-12-NK

Installation accessories ——— ACC-AL149B-WT-BK-0200



AL180 NEW Ceiling light

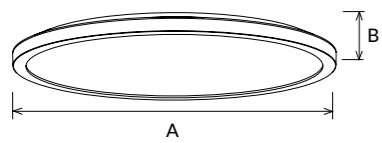

AL180 super slim ceiling light, adopt high lumen SMD LED, flicker-free led driver, PC diffuser with uniform light. IP54 weather proof, Interchangeable CCT available.

- ▶ 120°
- ▶
- ▶
- ▶

Code	Watt	Size(AxBxCmm)	Lumen(±5%)	N.W/pc(kgs)	Q'ty/CTN
AL180-10-12W	12W	Ø250x27	1200lm	0.38	12PCS
AL180-12-18W	18W	Ø300x27	1800lm	0.45	12PCS
AL180-16-25W	25W	Ø400x27	2500lm	0.60	12PCS

CCT ——— 3000K 4000K 5000K 5700K

Finish ——— White



AL85 Ceiling light

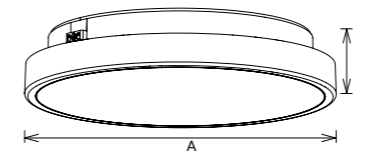

AL85 is an economic and integrated slim design ceiling light with high luminous flux; Waterproof function (IP54) expand the application area; Presser device makes the installation easier; Triac dimmable, Color switchable combines dimmable both available. Available for both rear and side cable entry.

- ▶ 110°
- ▶
- ▶
- ▶

Code	Watt	Size(AxBmm)	Lumen(±5%)	N.W/pc(kgs)	Q'ty/CTN
AL85-10-10W	10W	Ø250x64	1060lm	0.50	20PCS
AL85-12-18W	18W	Ø300x66.5	1820lm	0.70	10PCS
AL85-16-24W	24W	Ø400x69	2600lm	1.14	10PCS

CCT ——— 3000K 4000K 5000K 5700K

Finish ——— White Black Silver

Ring ——— ACC-AL85 Nickel Brushed



AL181 NEW Ceiling light

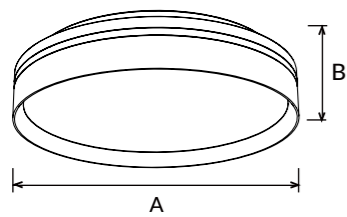

AL181 as ambient lighting and direct lighting, adopts high lumen SMD LED and lighter weight fire-rated material to ensure better heat resistance and corrosion resistance. Available for both rear and side cable entry.

- ▶ 110° IP44 IP40
- ▶ DIM Flicker Free SLIDE SWITCH 3 in 1
- ▶ AC 220-240V PF≥0.9 CRI≥80
- ▶ SAA RoHS CE

Code	Watt	Size(AxBmm)	Lumen(±5%)	N.W/pc(kgs)	Q'ty/CTN
AL181-10-12W	12W	Ø250x69	1400lm	0.75	12PCS
AL181-12-15W	15W	Ø300x71	1850lm	1.00	6PCS
AL181-12-20W	20W	Ø300x71	2400lm	1.00	6PCS

CCT ——— 3000K 4000K 5000K 5700K

Finish ——— White Golden

Ambient Lighting

Surface mounted
IP44



Suspended
(DIY Suspended Kits)
IP40



LED Ceiling light



Foot pad, Available both rear and side cable entry

Loop in/ Loop out



AL145 Ceiling light

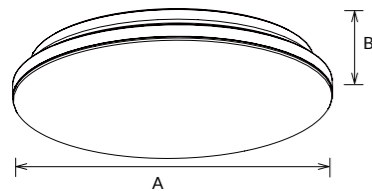

AL145 ceiling light with super slim and frameless curved design, IP54 waterproof, adopt high lumen SMD LED, PC body and PC diffuser to ensure high quality. Interchangeable CCT by slide switch, Emergency, Microwave sensor and Daylight sensor are optional. Available for both rear and side cable entry.

- ▶ 120° Beam angle, IP54, IK06
- ▶ DIM, Flicker Free, SLIDE SWITCH 3 in 1, Microwave sensor icon, Daylight sensor icon
- ▶ AC 220-240V, PF≥0.9, CRI≥80
- ▶ SAA, RoHS, CE

Code	Watt	Size(AxBmm)	Lumen(±5%)	N.W/pc(kgs)	Q'ty/CTN
AL145-11-12W	12W	Ø275x60	1350lm	0.75	14PCS
AL145-11-18W	18W	Ø275x60	2100lm	0.75	14PCS
AL145-14-18W	18W	Ø350x60	2120lm	1.28	7PCS
AL145-14-25W	25W	Ø350x60	2940lm	1.28	7PCS

CCT 3000K 4000K 5000K 5700K

Finish White



AL87 Ceiling light

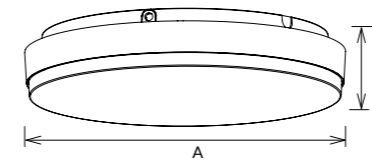

AL87 is a new super slim design ceiling light, adopting high lumen SMD LED and lighter weight fire-rated material to ensure better heat resistance and corrosion resistance. The base and shade are detachable which make easier maintenance and installation. It also supports functions including Triac, 0-10V, DALI dimmable; Changeable power and 3 CCT by DIP switch(optional); Adjustable sensor and Emergency etc. Available for both rear and side cable entry.

- ▶ 120° Beam angle, IP54, IK08
- ▶ DIM, DALI, 0-10V, Flicker Free
- ▶ SLIDE SWITCH 3 in 1, Microwave sensor icon, Daylight sensor icon, Adjustable Power
- ▶ AC 100-240V, AC 200-240V, PF≥0.9, CRI≥80
- ▶ SAA, RoHS, CE

Code	Watt	Size(AxBmm)	Lumen(±5%)	N.W/pc(kgs)	Q'ty/CTN
AL87-11-12W	12W	Ø275x65	1460lm	0.70	12PCS
AL87-11-18W	18W	Ø275x65	2200lm	0.70	12PCS
AL87-11-25W	25W	Ø275x65	3000lm	0.70	12PCS
AL87-14-25W	25W	Ø350x65	2900lm	1.00	6PCS
AL87-14-30W	30W	Ø350x65	3300lm	1.00	6PCS

CCT 3000K 4000K 5000K 5700K

Finish White



AL126 Ceiling light

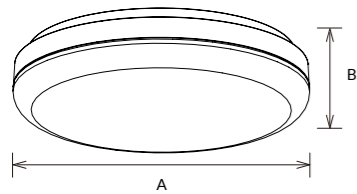

AL126 adopts high lumen SMD LED and lighter weight fire-rated material to ensure better heat resistance and corrosion resistance. The base and shade are detachable which make easier maintenance and installation. Available for both rear and side cable entry.

- ▶ 120°
- ▶
- ▶
- ▶

Code	Watt	Size(AxBmm)	Lumen(±5%)	N.W/pc(kgs)	Q'ty/CTN
AL126-10-12W	12W	Ø250x68	1300lm	0.60	12PCS
AL126-12-18W	18W	Ø300x68	2000lm	0.80	12PCS
AL126-12-24W	24W	Ø300x68	2600lm	0.80	12PCS
AL126-16-24W	24W	Ø400x72	2650lm	1.40	6PCS
AL126-16-30W	30W	Ø400x72	3100lm	1.40	6PCS

CCT ——— 3000K 4000K 5000K 5700K

Finish ——— White

AL126 MODULAR DESIGN



Driver & Light Source interchangeable

Easily installation and replacement

Middle/ Side entry both available

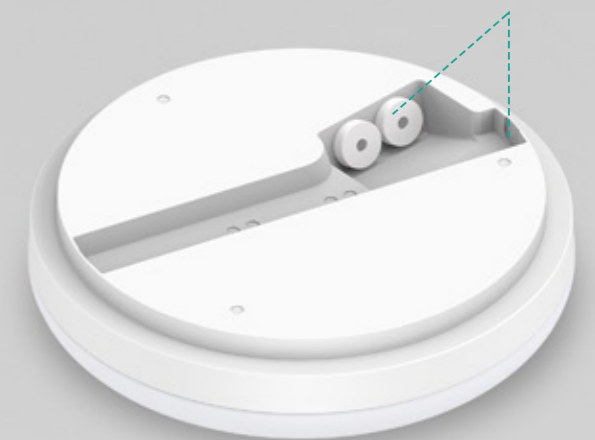



AL122 Ceiling light

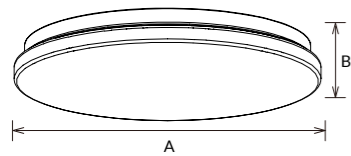

AL122 economical LED ceiling light adopts led lens to ensure uniform light effect. Integrated design for LEDs and driver can help maintenance. Interchangeable CCT with slide switch, IP54 waterproof for room side.

- ▶ 120° IP54 DIM Flicker Free SLIDE SWITCH 3 in 1
- ▶ AC 200-240V PF ≥ 0.9 CRI ≥ 80
- ▶ SAA RoHS CE

Code	Watt	Size(AxBmm)	Lumen(±5%)	N.W/pc(kgs)	Q'ty/CTN
AL122-10-12W	12W	Ø250X58	1100lm	0.44	10PCS
AL122-12-16W	16W	Ø300X65	1400lm	0.66	10PCS
AL122-16-24W	24W	Ø400X71	2200lm	1.05	6PCS
AL122-10-12W(Module)	12W	Ø190X23	1500lm	0.18	20PCS
AL122-12-16W(Module)	16W	Ø227X23	2000lm	0.25	20PCS
AL122-16-24W(Module)	24W	Ø297X23	2900lm	0.31	12PCS

CCT ——— 3000K ——— 4000K ——— 5700K

Finish ——— White



+

Magnet
Quick installation
Easy replacement

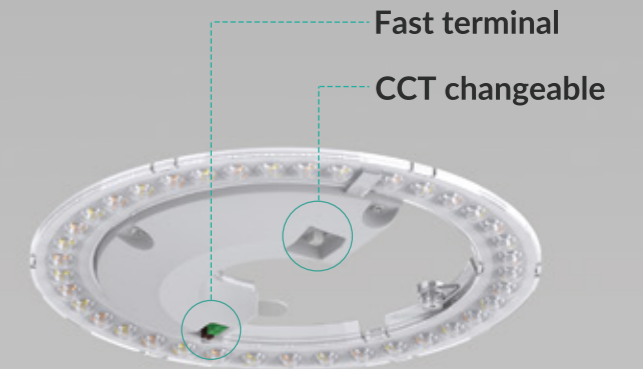

+



Can directly replace
fluorescent light tube



LED Ceiling light

AL122 MAGNETIC ASSEMBLY & MODULAR



AL165 Ceiling light

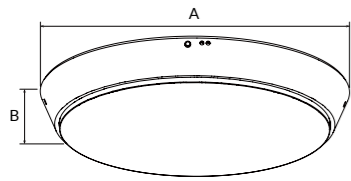

AL165 LED ceiling light adopts high lumen SMD LED with 120lm/W light efficiency. It is IP44 and IK06 protection level. Multiple functions for options: triac dim, CCT interchangeable, sensor and emergency.

- ▶ 120°
- ▶ IP44
- ▶ IK06
- ▶ DIM
- ▶ Flicker Free
- ▶ 3 in 1
- ▶ ((·))
- ▶
- ▶ AC 220-240V
- ▶ PF ≥ 0.9
- ▶ CRI ≥ 80
- ▶ SAA
- ▶ RoHS
- ▶ CE

Code	Watt	Size(AxBxCmm)	Lumen(±5%)	N.W/pc(kgs)	Q'ty/CTN
AL165-10-12W	12W	Ø250x50	1500lm	0.65	12PCS
AL165-12-12W	12W	Ø300x50	1500lm	1.00	6PCS
AL165-12-18W	18W	Ø300x50	2200lm	1.00	6PCS
AL165-16-25W	25W	Ø420x50	3100lm	1.65	6PCS
AL165-16-30W	30W	Ø420x50	3600lm	1.65	6PCS

CCT ——— 3000K 4000K 5000K 5700K

Finish ——— White



LED Ceiling light



DIY Your Idea

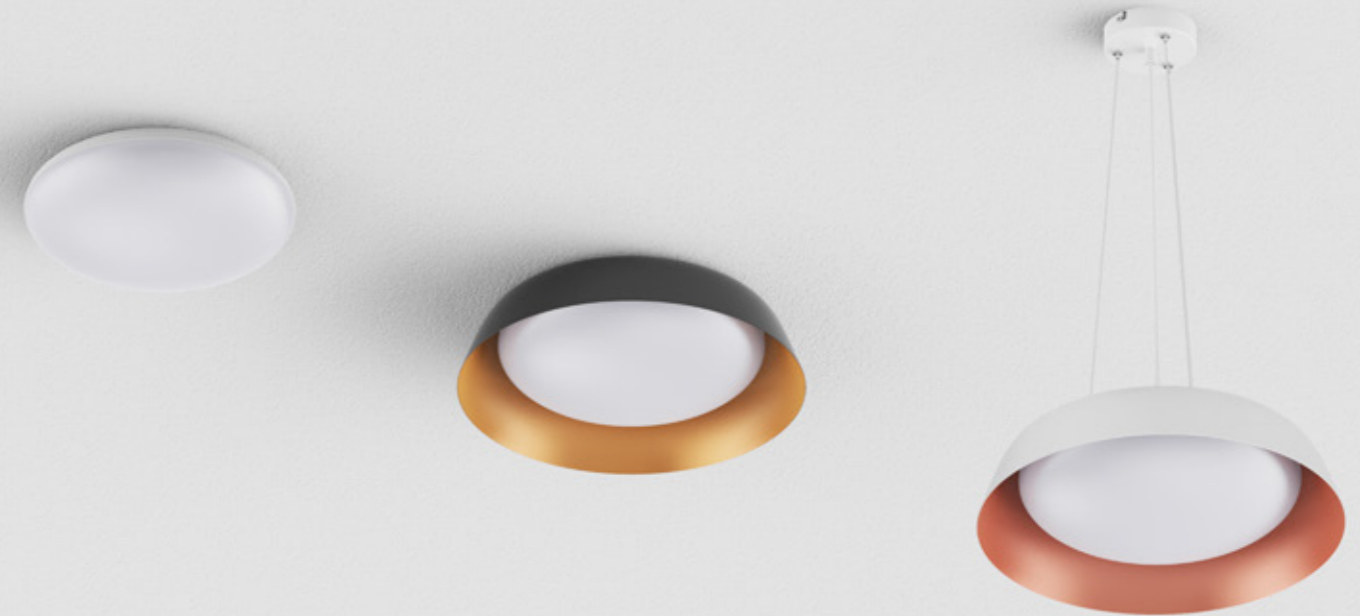

AL175 NEW Ceiling light

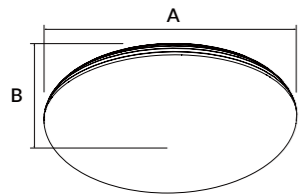

- ▶ 120° IP54
- ▶ DIM Flicker Free SLIDE SWITCH 3 in 1
- ▶ AC 220-240V PF≥0.9 CRI≥80
- ▶ SAA RoHS CE

AL175 LED ceiling light is a frameless cobblestone shape design, adopting high lumen SMD LED, flicker-free led driver, PC diffuser with uniform light. IP54 weather proof, Interchangeable CCT available. Can be with different color decoration rings as new surface looking.

Code	Watt	Size(AxBxCmm)	Lumen(±5%)	N.W/pc(kgs)	Q'ty/CTN
AL175-10-12W	12W	Ø250x93	1500lm	0.65	4PCS
AL175-12-18W	18W	Ø300x93	2350lm	0.90	4PCS
AL175-16-25W	25W	Ø400x93	3300lm	1.55	4PCS

CCT — 3000K 4000K 5000K 5700K

Finish — White

Decoration ring — White RAL9016 Copper RAL3012 Gold RAL1034

Installation accessories — ACC-AL175-300-WT ACC-AL175-300-BK

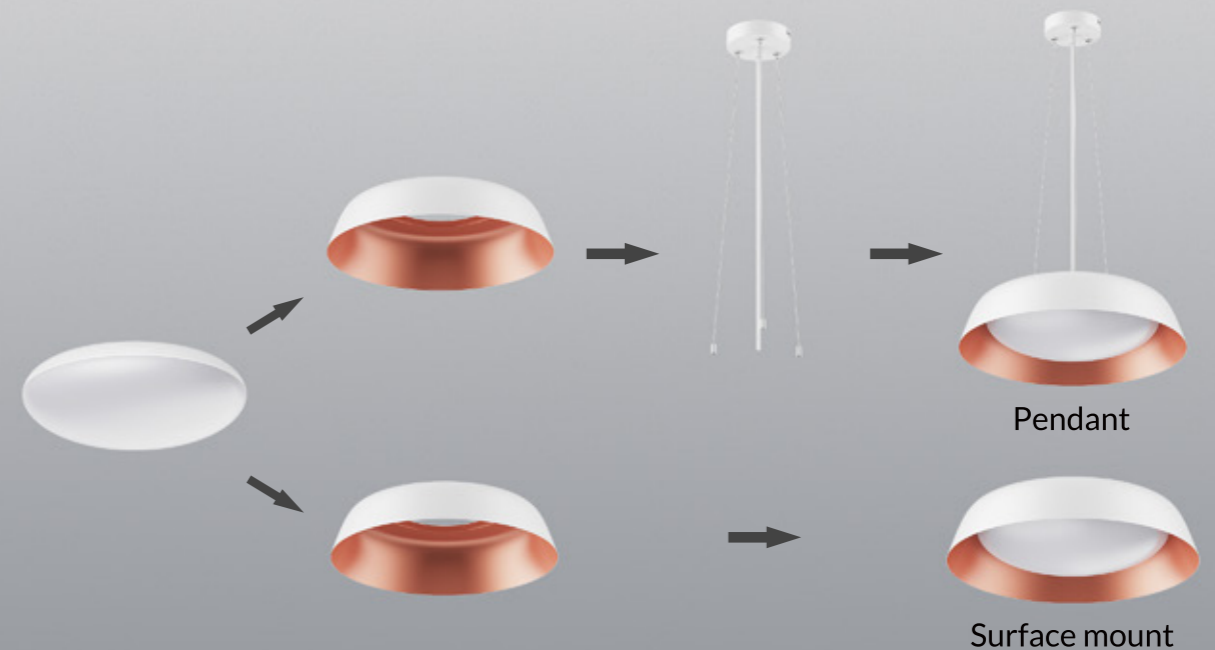

LED Ceiling light

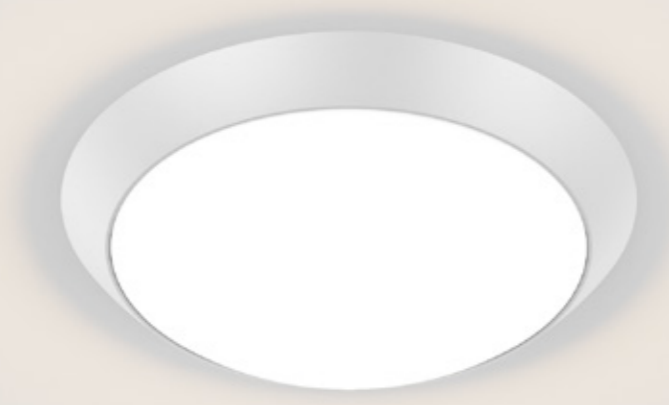

AL137 Ceiling light

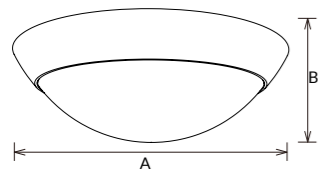

AL137 LED ceiling light with oyster design, which adopts PC cover. 120° beam angle and IP44 waterproof are available. Multiple functions: dim, 3 CCT changeable, sensor and emergency. Available for both rear and side cable entry.

- ▶ 120°
- ▶ IP44
- ▶ IK06
- ▶ Flicker Free
- ▶ SLIDE SWITCH 3 in 1
- ▶ ((••))
- ▶ 🚶
- ▶ AC 200-240V
- ▶ PF ≥ 0.9
- ▶ CRI ≥ 80
- ▶ SAA
- ▶ RoHS
- ▶ CE

Code	Watt	Size(AxBmm)	Lumen(±5%)	N.W/pc(kgs)	Q'ty/CTN
AL137-10-12W	12W	Ø250x86	1400lm	0.50	12PCS
AL137-12-15W	15W	Ø300x90	1800lm	0.85	10PCS
AL137-16-18W	18W	Ø420x110	2200lm	1.50	6PCS
AL137-16-25W	25W	Ø420x110	3000lm	1.50	6PCS

CCT — 3000K — 4000K — 5000K — 5700K

Finish — White



AL137B Ceiling light

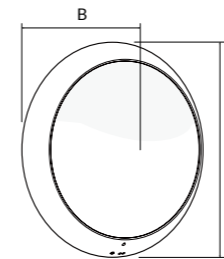

AL137B LED wall lamp is with arc surface design with 30° downward polarized light, adopting high lumen SMD LED and PC cover. Multiple functions with triac dim, CCT interchangeable, sensor and emergency. Available for both rear and side cable entry.

- ▶ 120°30° Polarization
- ▶ IP40
- ▶ IK06
- ▶ DIM
- ▶ Flicker Free
- ▶ SLIDE SWITCH 3 in 1
- ▶ ((••))
- ▶ 🚶
- ▶ AC 200-240V
- ▶ PF ≥ 0.9
- ▶ CRI ≥ 80
- ▶ SAA
- ▶ RoHS
- ▶ CE

Code	Watt	Size(AxBmm)	Lumen(±5%)	N.W/pc(kgs)	Q'ty/CTN
AL137B-12-18W	18W	Ø300x90	2000lm	0.85	6PCS

CCT — 3000K — 4000K — 5000K — 5700K

Finish — White



Super Slim Ambient Lighting

AL170 NEW Ceiling light

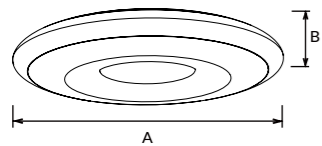

- ▶ 120° IP40
- ▶ DIM Flicker Free SLIDE SWITCH 3 in 1 ((••))
- ▶ AC 220-240V PF≥0.9 CRI≥80
- ▶ SAA RoHS CE

AL170 is a new super slim design ceiling light, It has a round decorative frame in front and backlit lighting design show a black hole lighting effect. IP40 and IK06 protection level. 300mm and 400mm available, It also comes with microwave sensor function.

Code	Watt	Size(AxBxCmm)	Lumen(±5%)	N.W/pc(kgs)	Q'ty/CTN
AL170-12-18W	18W	Ø300x50	1900lm	0.9	6PCS
AL170-16-18W	18W	Ø400x55	1900lm	1.5	6PCS
AL170-16-25W	25W	Ø400x55	2700lm	1.5	6PCS

CCT ——— 3000K 4000K 5000K 5700K

Finish ——— White



AL170-12"

AL170-16"

LED Ceiling light

3-CCT interchangeable

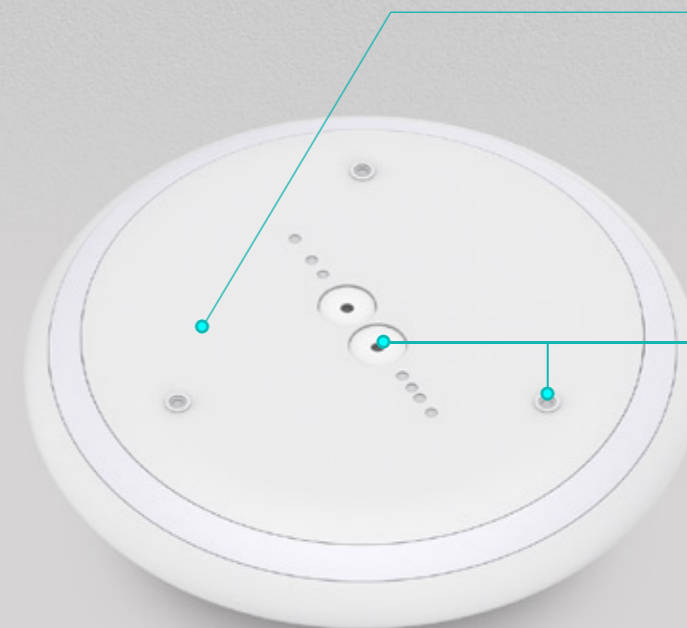
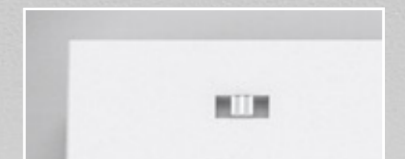

Loop In/Out

Foot pad, Available both rear and side cable entry



AL148 Ceiling light

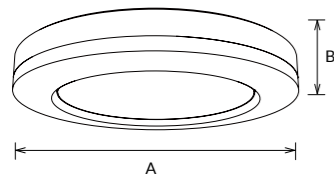

AL148 ceiling light(full PC) is an elegant and concave design, which makes the luminous surface compact and with magic 3D effects.The middle decorative plate could be customized for different color. Surface mounted and suspended installation for option.

- 120°
- IP40
- IK06
- DIM
- DALI
- Flicker Free
- SLIDE SWITCH 3 in 1
- ((-))
-
- AC 220-240V
- PF≥0.9
- CRI≥80
- SAA
- RoHS
- CE

Code	Watt	Size(AxBmm)	Lumen(±5%)	N.W/pc(kgs)	Q'ty/CTN
AL148-12-17W	17W	Ø300x52	1730lm	1.30	6PCS
AL148-16-25W	25W	Ø400x52	2620lm	1.65	6PCS

CCT ——— 3000K 4000K 5000K 5700K

Finish ——— White

Installation accessories ——— ACC-AL148-WT-0200



AL141 Ceiling light

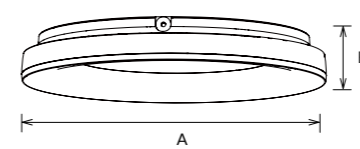

AL141 LED frameless ceiling light adopts concave design. It is IP44 and IK06 protection level. Edge cable entry and back side cable entry are available. Multiple functions for options: emergency, microwave sensor, adjustable CCT, dimmable. Available for both rear and side cable entry for surface mounted installation. Available for both rear and side cable entry.

- 120°
- IP40
- IP44
- IK06
- DIM
- Flicker Free
- SLIDE SWITCH 3 in 1
- ((-))
-
- AC 220-240V
- PF≥0.9
- CRI≥80
- SAA
- RoHS
- CE

Code	Watt	Size(AxBmm)	Lumen(±5%)	N.W/pc(kgs)	Q'ty/CTN
AL141-12-12W	12W	Ø300x60	1320lm	0.75	12PCS
AL141-12-18W	18W	Ø300x60	1650lm	0.75	12PCS
AL141-16-18W	18W	Ø400x60	1750lm	1.28	6PCS
AL141-16-25W	25W	Ø400x60	2550lm	1.28	6PCS

CCT ——— 3000K 4000K 5000K 5700K

Finish ——— White

Installation accessories ——— ACC-AL141-WT-0200



AL24A Ceiling light

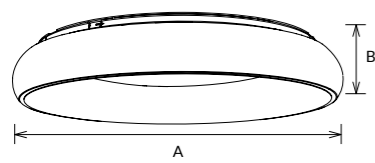

AL24A is with hollow shape and curved light direction design, the circular light output offers a magic 3D effect; rotate buckle on the base to make installation easier and faster, it's very suitable for leisure location.

- ▶ 120° IP40
- ▶ DIM Flicker Free
- ▶ AC 100-277V AC 200-240V PF≥0.9 CRI≥80
- ▶ SAA RoHS CE CB

Code	Watt	Size(AxBmm)	Lumen(±5%)	N.W/pc(kgs)	Q'ty/CTN
AL24A-12-18W	18W	Ø298x51	1450lm	1.08	10PCS
AL24A-12-25W	25W	Ø298x51	2000lm	1.08	10PCS
AL24A-16-35W	35W	Ø400x68	3100lm	1.89	6PCS

CCT ——— 3000K 4000K 5000K 5700K Finish ——— White Black Silver

Installation accessories ——— ACC-AL24A-12-WT



AL24B Ceiling light

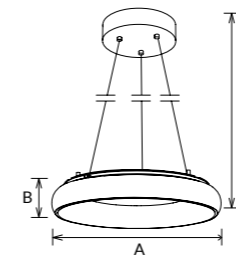

AL24B is with hollow shape, curved light direction and suspended installation design, the circular light output offers a magic 3D effect; rotate buckle on the base to make installation easier and faster, it's very suitable for leisure location.

- ▶ 120° IP40
- ▶ DIM Flicker Free
- ▶ AC 100-277V AC 200-240V PF≥0.9 CRI≥80
- ▶ SAA RoHS CE CB

Code	Watt	Size(AxBxCmm)	Lumen(±5%)	N.W/pc(kgs)	Q'ty/CTN
AL24B-12-18W	18W	Ø298x50x1525	1450lm	0.87	10PCS
AL24B-12-25W	25W	Ø298x50x1525	2000lm	0.87	10PCS
AL24B-16-35W	35W	Ø400x67x1542	3100lm	1.55	6PCS

CCT ——— 3000K 4000K 5000K 5700K Finish ——— White Black Silver

Installation accessories ——— ACC-AL24A-12-WT

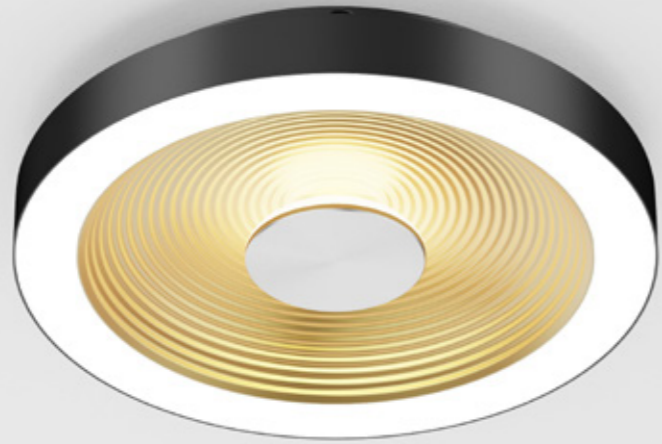

Main light + Ambient light



AL173 NEW Ceiling light

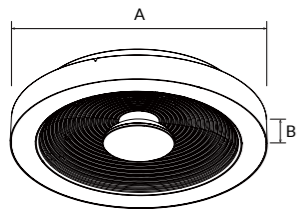

AL173 is decorative ceiling light with main light and ambient light design. The wavy lines cover adopts CD pattern processing technology, which makes the whole lamp highly recognizable, aesthetic and advanced visual perception. Surface mounted and suspension are optional. IP54 and 3-CCT are available.

- ▶
- ▶
- ▶
- ▶

Code	Watt	Size(AxBmm)	Lumen(±5%)	N.W/pc(kgs)	Q'ty/CTN
AL173-12-18W	18W	Ø320x64	1200lm	1.06	6PCS
AL173-16-25W	25W	Ø400x64	1750lm	1.35	6PCS

CCT ——— 3000K 4000K 5000K 5700K Finish ——— White Black Golden

Installation accessories ——— ACC-AL166-WT-BK-0200



LED Ceiling light



Surface mounted ACC-AL166-WT/BK-0200 Pendant

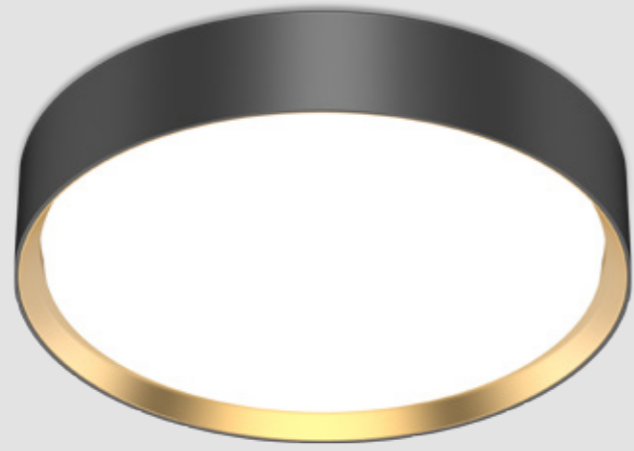

AL166 Ceiling light

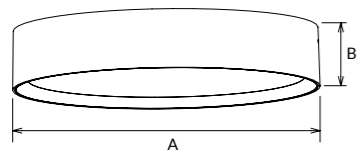

AL166 is a aluminum LED ceiling light with stylish and modern design, with golden/ white/ black decorative rings. It can do multiple installation with surface, recessed/ suspension with accessories easily.

- ▶ 120° IP44 IP20
- ▶ IK06
- ▶ DIM DALI Flicker Free SLIDE SWITCH
- ▶ AC 220-240V PF ≥ 0.9 CRI ≥ 80
- ▶ SAA RoHS CE CB

Code	Watt	Size(AxBmm)	Cut-out(mm)	Lumen(±5%)	N.W/pc(kgs)	Q'ty/CTN
AL166-12-18W	18W	Ø301x58	Ø320x85	1800lm	1.30	6PCS
AL166-12-24W	24W	Ø301x58	Ø320x85	2500lm	1.30	6PCS
AL166-16-24W	24W	Ø422x58	Ø440x85	2750lm	2.20	6PCS
AL166-16-30W	30W	Ø422x58	Ø440x85	3400lm	2.20	6PCS

CCT ——— 3000K 4000K 5000K 5700K Finish ——— White Black Silver

Installation accessories ——— ACC-AL166-WT-BK-0200 ACC-AL166-12-WT-0300 ACC-AL166-16-WT-0300



AL166

Elegant design with uniform lighting



Multiple installations



• AL99C
Flat



• AL99D
Curved
(Recessed)

AL99C/D NEW Ceiling light

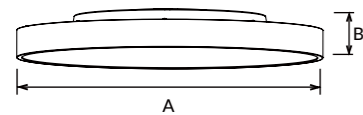

AL99C/D ceiling light is with AL6063 aluminum housing, high efficiency SMD LED chips, Opal or Microprismatic diffuser, AL99C as flat surface, AL99D as recessed surface. It can be Up&down lighting and down lighting only. Multiple installation ways available as surface mounted, recessed, suspended.

- ▶ 85° 120° IP40
- ▶ DALI Flicker Free SLIDE SWITCH 3 in 1
- ▶ AC 220-240V PF ≥ 0.9 CRI ≥ 80
- ▶ SAA RoHS CE

Code	Watt	Size(AxBmm)	Cut-out(mm)	Lumen(±5%)	N.W/pc(kgs)	Q'ty/CTN
AL99C-16-40W	40W	Ø400x86	Ø220-250	4450lm	2.61	6PCS
AL99C-24-60W	60W	Ø600x86	Ø385-415	6920lm	5.96	2PCS
AL99C-32-75W	75W	Ø800x86	Ø385-415	9100lm	7.17	1PCS
AL99C-40-100W	100W	Ø1000x86	Ø385-415	11920lm	10.83	1PCS
AL99D-16-40W	40W	Ø400x86	Ø220-250	4450lm	2.61	6PCS
AL99D-24-60W	60W	Ø600x86	Ø385-415	6920lm	5.96	2PCS
AL99D-32-75W	75W	Ø800x86	Ø385-415	9100lm	7.17	1PCS
AL99D-40-100W	100W	Ø1000x86	Ø385-415	11920lm	10.83	1PCS

CCT 3000K 4000K 5000K 5700K

Finish White Black Wood grain



Steel wire suspension



Wire harness suspension



Pendant rod suspension

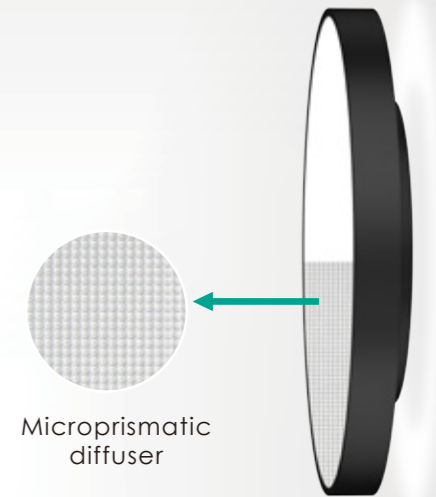

Microprismatic diffuser

Wall mounted
(Indirect lighting)



Wall mounted
(Direct lighting)



PD26 Ceiling light

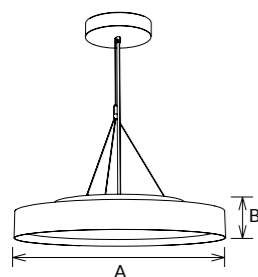

PD26 is a big size pendant light with hollow design. This lamp is adopted high lumen SMD LED light source, circle cut method makes PC shade without light leakage, which also offers a softer and uniform light output. AL6063 aluminium housing provides an excellent thermal management. Size options: 400mm, 600mm, 800mm, 1000mm.

- ▶ 105° IP20
- ▶ Flicker Free
- ▶ AC 220-240V PF≥0.9 CRI≥80
- ▶ SAA RoHS CE CB

Code	Watt	Size(AxBmm)	Lumen(±5%)	N.W/pc(kgs)	Q'ty/CTN
PD26A-35W	35W	Ø400x75	3400lm	3.10	4PCS
PD26A-54W	54W	Ø600x75	5300lm	4.60	2PCS
PD26A-70W	70W	Ø800x75	6700lm	6.00	1PCS
PD26A-84W	84W	Ø1000x75	8000lm	7.50	1PCS

CCT 3000K 4000K 5000K 5700K

Finish White Black



LED Ceiling light



AL174 Ceiling light

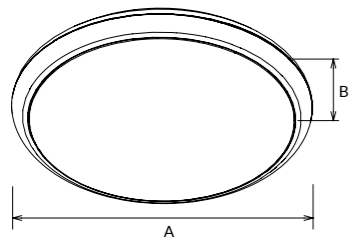

AL174 is IP65 water-proof ceiling light, available with adjustable CCT, microwave sensor, PIR sensor triac dim, DALI 2.0 push dim function. Screless surface, ceiling & wall mounting, and quick installation makes it an excellent model. Available for both rear and side cable entry.

-
-
-
-
-
-
-
-
-
-
-
-
-
-
-
-

Code	Watt	Size(AxBmm)	Lumen(±5%)	N.W/pc(kgs)	Q'ty/CTN
AL174-10-12W	12W	Ø250x70	1350lm	0.52	12PCS
AL174-12-18W	18W	Ø300x70	2030lm	0.85	6PCS
AL174-12-25W	25W	Ø300x70	2670lm	0.85	6PCS
AL174-16-25W	25W	Ø400x79	2750lm	1.38	6PCS
AL174-16-30W	30W	Ø400x79	3350lm	1.38	5PCS

CCT — 3000K — 4000K — 5000K — 5700K

Finish — White



10"



12"

Adjustable microwave sensor



16"



12"

PIR sensor 12inch only

LED Ceiling light

AL174 SERIES IP65 LED CEILING LIGHT



AL55A



AL55B

AL55 Ceiling light

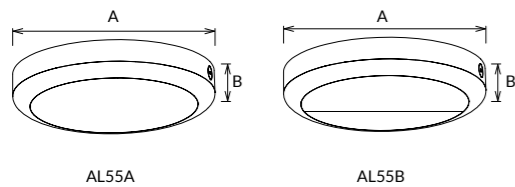

AL55 is a ceiling light which comes with multifunctions, triac dimmable, emergency, sensor, color switchable, wattage switchable. Its cover can be circular and semi-circular diffuser to create different lighting effect, IP54 and IP65 optional. Available for both rear and side cable entry.

- ▶ 110°
- ▶ IP65
- ▶ IK08
- ▶ DIM
- ▶ Flicker Free
- ▶ SLIDE SWITCH 2 in 1
- ▶ ((•••))
- ▶ Adjustable Power
- ▶ AC 200-240V
- ▶ PF≥0.9
- ▶ CRI≥80
- ▶ SAA
- ▶ RoHS
- ▶ CE
- ▶ CB

Code	Watt	Size(AxBmm)	Lumen(±5%)	N.W/pc(kgs)	Q'ty/CTN
AL55A-12-15W	15W	Ø300x60	1480lm	0.96	6PCS
AL55B-12-15W	15W	Ø300x60	1000lm	0.96	6PCS
AL55A-12-25W-A3	15W / 18W / 25W	Ø300x60	1410lm/1600lm/2120lm	0.92	6PCS
AL55A-12-25-AC	15W / 18W / 25W	Ø300x60	1470lm/1710lm/2320lm	0.92	6PCS
AL55B-12-25-A3	15W / 18W / 25W	Ø300x60	850lm/960lm/1270lm	0.92	6PCS
AL55B-12-25-AC	15W / 18W / 25W	Ø300x60	880lm/1030lm/1395lm	0.92	6PCS

CCT — 3000K — 4000K — 5000K — 5700K

Finish — White — Black

Ring — ACC-AL55

AL55 Series

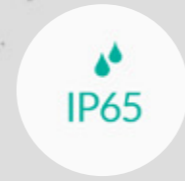

AL55A



AL55B

LED Ceiling light

Two option • Easy replace

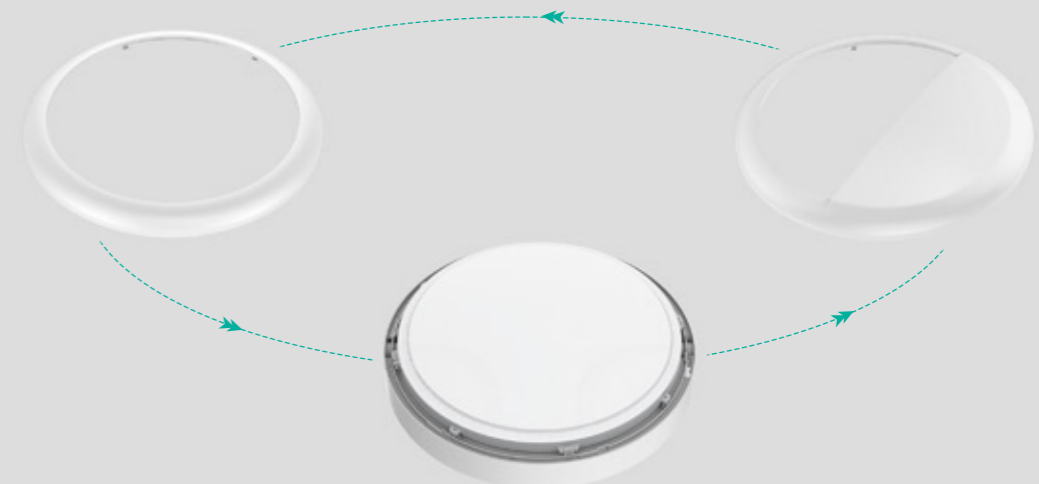

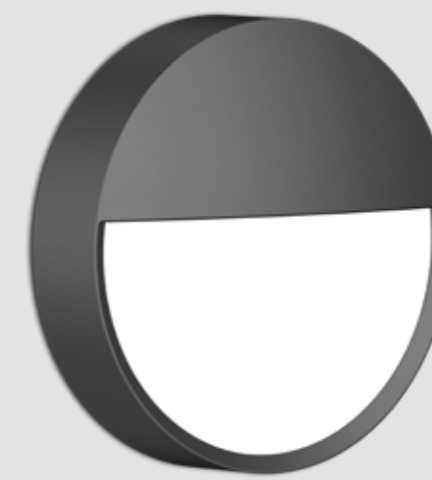
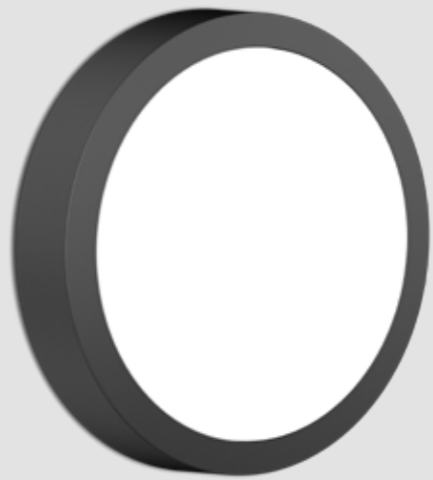

AL96 Bulkhead

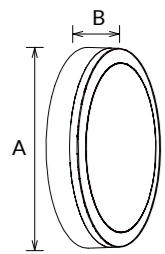

AL96 is IP65 and IK10 LED ceiling light, which adopts high lumen SMD LED and lighter weight fire-rated material to ensure better heat resistance and corrosion resistance. Wall mounted and surface mounted for options. Multiple functions such as 3 CCT and power interchangeable, emergency, adjustable sensor, triac/0-10V/DALI dimmable are available. Available for both rear and side cable entry.

-
-
-
-
-
-
-
-
-
-
-
-
-
-
-
-
-
-
-

Code	Watt	Size(AxBmm)	Lumen(±5%)	N.W/pc(kgs)	Q'ty/CTN
AL96-8-12W	12W	Ø200x60	1250lm	0.48	12PCS
AL96-11-12W	12W	Ø275x60	1300lm	0.85	12PCS
AL96-11-18W	18W	Ø275x60	1850lm	0.85	12PCS
AL96-11-25W	25W	Ø275x60	2530lm	0.85	12PCS
AL96-14-25W	25W	Ø350x60	2530lm	1.38	6PCS
AL96-14-30W	30W	Ø350x60	2920lm	1.38	6PCS

CCT — 3000K — 4000K — 5000K — 5700K

Finish — White Black



AL66 Bulkhead

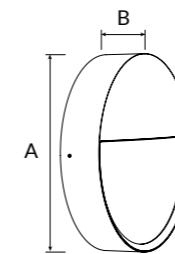

AL66 is IP65 IK08 bulkhead which adopts Die-casting aluminum body and 94-V0 fire-rated PC cover. This fixture provides an alternative to the color changeable. These lights is a perfect answer to complete your outdoor look.

-
-
-
-
-
-
-
-
-
-
-
-
-
-
-

Code	Watt	Size(AxBmm)	Lumen(±5%)	N.W/pc(kgs)	Q'ty/CTN
AL66-10-12W	12W	Ø250x74	1100lm	1.10	10PCS

CCT — 3000K — 4000K — 5000K — 5700K

Finish — White Black Silver

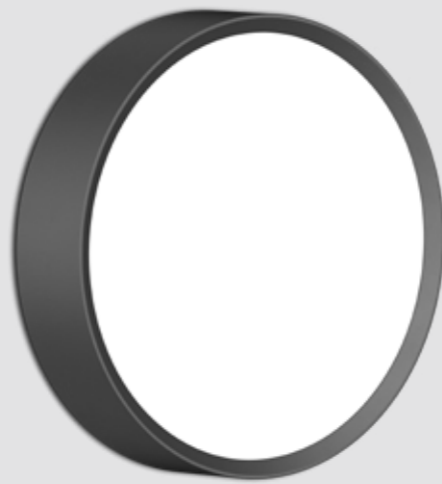

AL65 Bulkhead

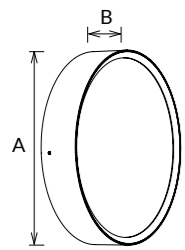

AL65 is IP65 IK08 bulkhead which adopts Die-casting aluminum body and 94-V0 fire-rated PC cover. This fixture provides an alternative to the color changeable and Emergency function. These lights is a perfect answer to complete your outdoor look.

- ▶ 110°
- ▶ IP65
- ▶ IK08
- ▶ DIM
- ▶ Flicker Free
- ▶ SLIDE SWITCH 3 in 1
- ▶ Emergency
- ▶ AC 200-240V
- ▶ PF ≥ 0.9
- ▶ CRI ≥ 80
- ▶ SAA
- ▶ RoHS
- ▶ CE
- ▶ CB

Code	Watt	Size(AxBmm)	Lumen(±5%)	N.W/pc(kgs)	Q'ty/CTN
AL65-10-12W	12W	Ø250x58	1250lm	1.05	10PCS
AL65-10-18W	18W	Ø250x58	1850lm	1.15	10PCS

AL65B Bulkhead

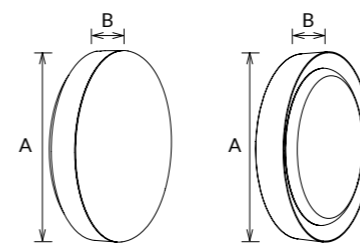

AL65B is IP65, IK08 bulkhead which adopts Die-casting aluminium body and 94-V0 fire-rated PC cover. This fixture is with four frames options and provides an alternative to color changeable, adjustable sensor and Emergency function. These lights is a perfect answer to complete your outdoor look.

- ▶ 120°
- ▶ IP65
- ▶ IK08
- ▶ DIM
- ▶ Flicker Free
- ▶ SLIDE SWITCH 3 in 1
- ▶ Emergency
- ▶ AC 200-240V
- ▶ PF ≥ 0.9
- ▶ CRI ≥ 80
- ▶ SAA
- ▶ RoHS
- ▶ CE

Code	Watt	Size(AxBmm)	Lumen(±5%)	N.W/pc(kgs)	Q'ty/CTN
AL65B-10-12W	12W	Ø251x64	1420lm	1.18	10PCS
AL65B-10-18W	18W	Ø251x64	2120lm	1.18	10PCS
AL65B-10-12W	12W	Ø300x64	1400lm	1.49	6PCS
AL65B-10-18W	18W	Ø300x64	2070lm	1.49	6PCS

CCT — 3000K 4000K 5000K 5700K Finish — White Black Gray

CCT — 3000K 4000K 5000K 5700K Finish — White Black

Ring — ACC-AL65B-10-BK-50

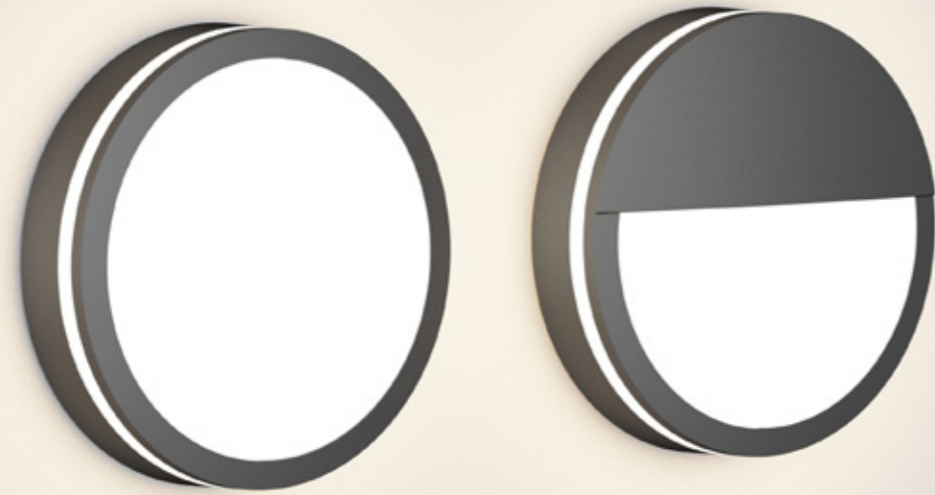

AL65C Bulkhead

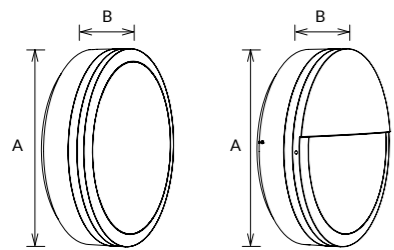

AL65 is IP65, IK08 bulkhead which adopts Die-casting aluminium body and 94-V0 fire-rated PC cover. This fixture is with four frames options and provides an alternative to color changeable, adjustable sensor and Emergency function. These lights is a perfect answer to complete your outdoor look.

- ▶
- ▶
- ▶
- ▶

Code	Watt	Size(AxBmm)	Lumen(±5%)	N.W/pc(kgs)	Q'ty/CTN
AL65C-10-12W	12W	Ø251x75	1030lm	1.34	10PCS
AL65C-10-18W	18W	Ø251x75	1530lm	1.34	10PCS
AL65C-10-12W	12W	Ø251x76	720lm	1.44	10PCS
AL65C-10-18W	18W	Ø251x76	970lm	1.44	10PCS

CCT ——— 3000K 4000K 5000K 5700K

Finish ——— White Black

Ring ———
ACC-AL65C-10-BK-50 ACC-AL65C-10-BK-51

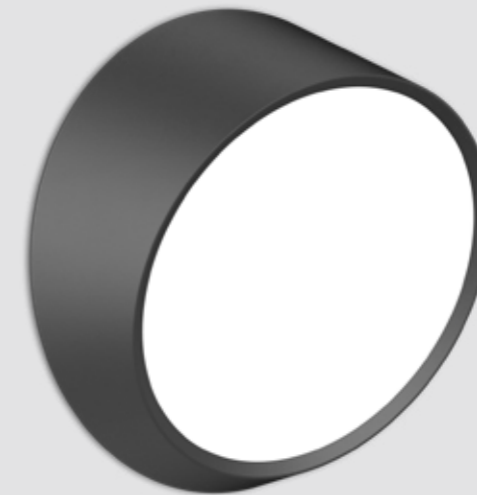

AL65D Bulkhead

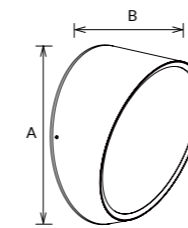

AL65D LED bulkhead which adopts high lumen 2835 SMD light source, PC diffuser and ADC12 aluminum. It has a high transmittance and uniform light output. High protection level IK06&IP65, high lumen efficiency 100lm/W with 110° beam angle are available. More functions: CCT interchangeable, triac dim with flicker free and S7 sensor.

- ▶
- ▶
- ▶
- ▶

Code	Watt	Size(AxBmm)	Lumen(±5%)	N.W/pc(kgs)	Q'ty/CTN
AL65D-10-15W	15W	Ø251x116	1500lm	1.09	12PCS

CCT ——— 3000K 4000K 5000K 5700K

Finish ——— White Black

LED Bulkhead

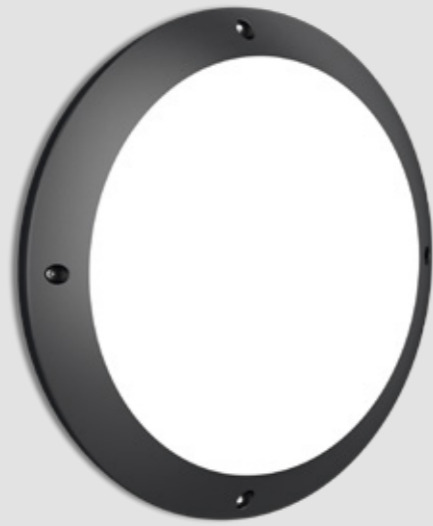

AL162 NEW Bulkhead

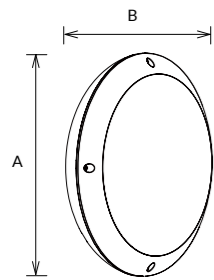

AL162 is an IP65 IK08 LED bulkhead with full bezel shape, adopting high lumen SMD LED and PC cover. It can do CCT interchangeable, adjustable sensor and emergency available. Available for both rear and side cable entry.

- ▶ 120° IP65 IK08
- ▶ Flicker Free SLIDE SWITCH 3 in 1 ((••))
- ▶ AC 200-240V PF≥0.8 PF≥0.9 CRI≥80
- ▶ SAA RoHS CE

Code	Watt	Size(AxBmm)	Lumen(±5%)	N.W/pc(kgs)	Q'ty/CTN
AL162-12-12W	12W	Ø300x95	1270lm	0.83	6PCS
AL162-12-14W	14W	Ø300x95	1490lm	0.83	6PCS
AL162-12-18W	18W	Ø300x95	1680lm	0.83	6PCS

AL163 NEW Bulkhead

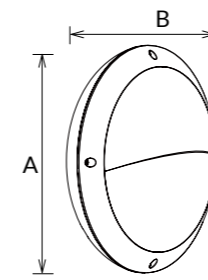

AL163 is an IP65 IK08 LED bulkhead with eyelid bezel shape, adopting high lumen SMD LED and PC cover. It can do CCT interchangeable, adjustable sensor and emergency available. Available for both rear and side cable entry.

- ▶ 120° IP65 IK08
- ▶ Flicker Free SLIDE SWITCH 3 in 1 ((••))
- ▶ AC 200-240V PF≥0.8 PF≥0.9 CRI≥80
- ▶ SAA RoHS CE

Code	Watt	Size(AxBmm)	Lumen(±5%)	N.W/pc(kgs)	Q'ty/CTN
AL163-12-12W	12W	Ø300x97	1020lm	0.85	6PCS
AL163-12-14W	14W	Ø300x97	1190lm	0.85	6PCS
AL163-12-18W	18W	Ø300x97	1340lm	0.85	6PCS



AL91 Bulkhead

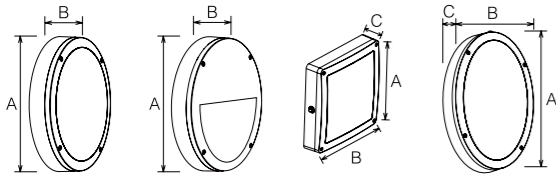

AL91 is with multiple shapes design, including circle, semicircle, square and oval. Adopt high lumen SMD LED and lighter weight fire-rated material which can ensure better heat resistance and be with corrosion resistance. Wall mounted and surface mounted available. The base and shade are detachable which make easier maintenance and installation. Remote sensor control for 15W & 25W. Available for both rear and side cable entry.

-

Code	Watt	Size(AxBxCmm)	Lumen(±5%)	N.W/pc(kgs)	Q'ty/CTN
AL91-11-12W-Circle	12W	Ø275x59	1250lm	0.76	12PCS
AL91-11-18W-Circle	18W	Ø275x59	1780lm	0.76	12PCS
AL91-11-25W-Circle	25W	Ø275x59	2450lm	0.76	12PCS
AL91-14-25W-Circle	25W	Ø350x59	2450lm	1.19	6PCS
AL91-14-30W-Circle	30W	Ø350x59	2850lm	1.19	6PCS
AL91-11-12W-Semicircle	12W	Ø275x59	1150lm	0.77	12PCS
AL91-11-18W-Semicircle	18W	Ø275x59	1650lm	0.77	12PCS
AL91-10-12W-Square	12W	242x242x59	1250lm	0.72	12PCS
AL91-10-18W-Square	18W	242x242x59	1780lm	0.72	12PCS
AL91-12-12W-Oval	12W	320x230x60	1250lm	0.78	12PCS
AL91-12-18W-Oval	18W	320x230x60	1780lm	0.78	12PCS
AL91-12-25W-Oval	25W	320x230x60	2450lm	0.78	12PCS

CCT: 3000K, 4000K, 5000K, 5700K | Finish: White, Black

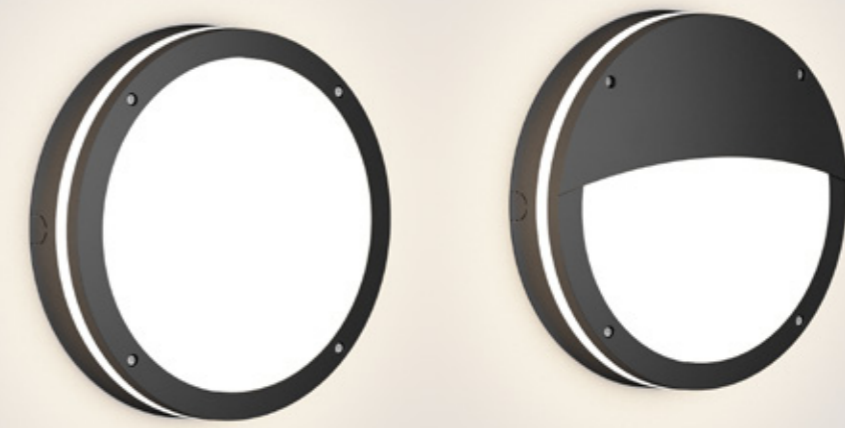

AL91E Bulkhead

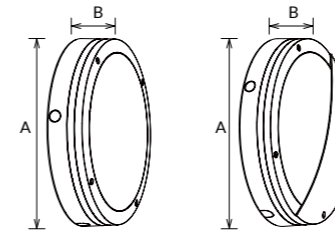

AL91E LED ceiling light with modular design which adopts high lumen SMD LED, fire-rated material. It has a wide lighting area with down lighting and side lighting. IP65 and IK10 are suitable for outdoor application. Multiple functions: interchangeable CCT and power, adjustable sensor, emergency. And DALI/0-10V/Triac dimmable are available. Available for both rear and side cable entry.

-

Code	Watt	Size(AxBmm)	Lumen(±5%)	N.W/pc(kgs)	Q'ty/CTN
AL91E-11-12W(Circle)	15W	Ø275x67	1150lm	0.92	12PCS
AL91E-11-18W(Circle)	18W	Ø275x67	1650lm	0.92	12PCS
AL91E-11-25W(Circle)	25W	Ø275x67	2250lm	0.92	12PCS
AL91E-11-12W(Semicircle)	12W	Ø275x68	750lm	0.95	12PCS
AL91E-11-18W(Semicircle)	18W	Ø275x68	1100lm	0.95	12PCS
AL91E-11-25W(Semicircle)	25W	Ø275x68	1550lm	0.95	12PCS

CCT: 3000K, 4000K, 5000K, 5700K | Finish: White, Black | Ring: ACC-AL91E



AL91F Bulkhead

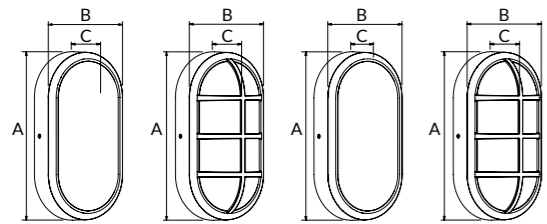

- ▶
- ▶
- ▶
- ▶

AL91F is IP65 IK08 bulkhead with oval shape and surface frame DIY design, adopting high lumen SMD LED, frosted PC cover with even and soft lighting. CCT interchangeable with slide switch and PIR sensor function available. Available for both rear and side cable entry.

Code	Watt	Size(AxBxCmm)	Lumen(±5%)	N.W/pc(kgs)	Q'ty/CTN
AL91F-8-5W	5W	220x120x66	600lm	0.40	30PCS
AL91F-8-10W	10W	220x120x66	1100lm	0.40	30PCS
AL91F-8-5W	5W	220x120x69	500lm	0.40	30PCS
AL91F-8-10W	10W	220x120x69	900lm	0.40	30PCS
ACC-AL91F-8-BK-50	-	220x120x36.5	-	0.06	30PCS
ACC-AL91F-8-WH-50	-	220x120x36.5	-	0.06	30PCS
ACC-AL91F-8-BK-51	-	220x120x69	-	0.07	30PCS
ACC-AL91F-8-WH-51	-	220x120x69	-	0.07	30PCS

CCT ——— 3000K 4000K 5000K 5700K

Finish ——— White Black

DIY Design

AL91F



- PIR sensor Adjustable
- Detection Area
- Hold Time
- Daylight Sensor

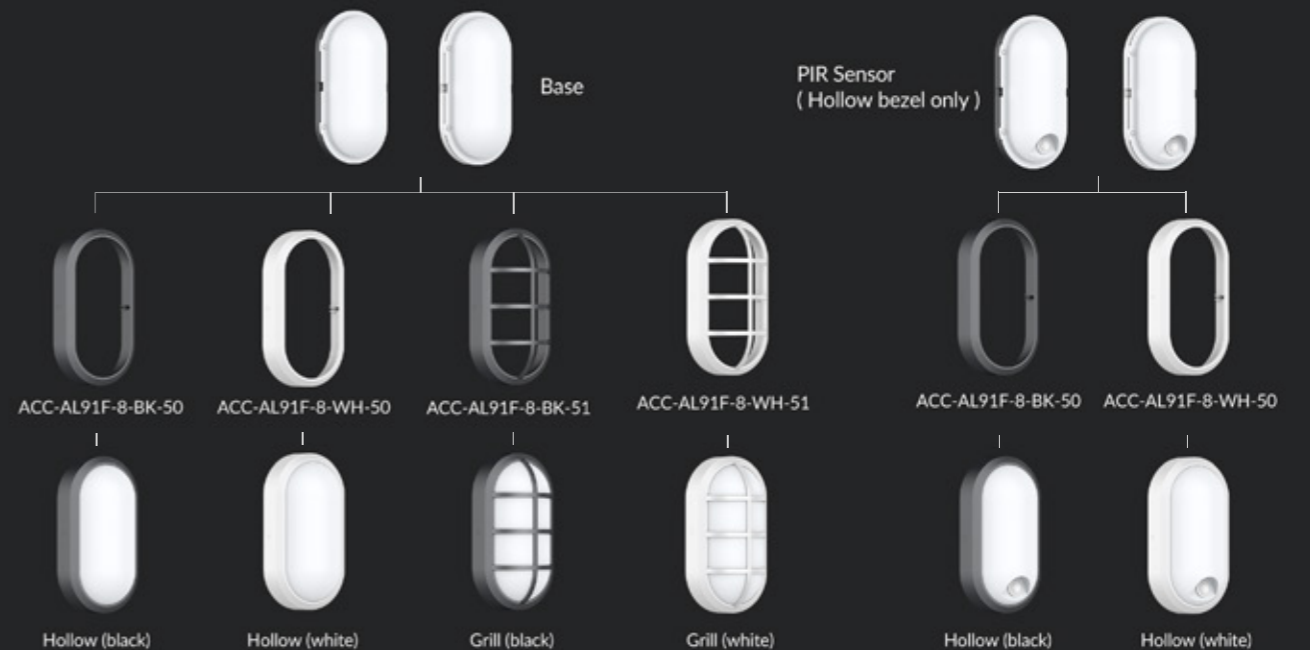

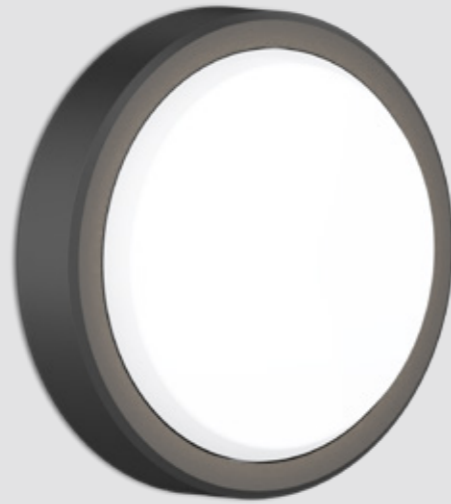

AL104 Bulkhead

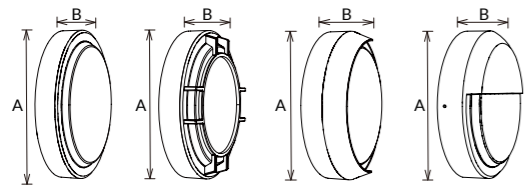

AL104 is IP65 IK10 bulkhead which adopts Die-casting Aluminum body and 94-V0 fire-rated PC cover. This fixture is with four different trims and provides an alternative to color changeable, sensor and emergency functions. Dali and 0-10V dimming is also available.

- ▶ 110° IP65 IK10
- ▶ DIM DALI 0-10V Flicker Free
- ▶ SLIDE SWITCH 3 in 1 Wireless signal Adjustable Power
- ▶ AC 200-240V PF≥0.9 CRI≥80
- ▶ SAA RoHS CE

Code	Watt	Size(AxBmm)	Lumen(±5%)	N.W/pc(kgs)	Q'ty/CTN
AL104A-10-15W	15W	Ø250X63	1750lm	1.05	10PCS
AL104B-10-15W	15W	Ø250X68	1500lm	1.15	10PCS
AL104C-10-15W	15W	Ø250X83	1600lm	1.19	10PCS
AL104D-10-15W	15W	Ø250X67	1100lm	1.38	10PCS
AL104A-12-25W	25W	Ø300X63	3000lm	1.58	6PCS
AL104B-12-25W	25W	Ø300X68	2150lm	1.69	6PCS
AL104C-12-25W	25W	Ø300X83	2600lm	1.73	6PCS
AL104D-12-25W	25W	Ø300X67	1900lm	2.05	6PCS

CCT ——— 3000K 4000K 5000K 5700K

Finish ——— White Black

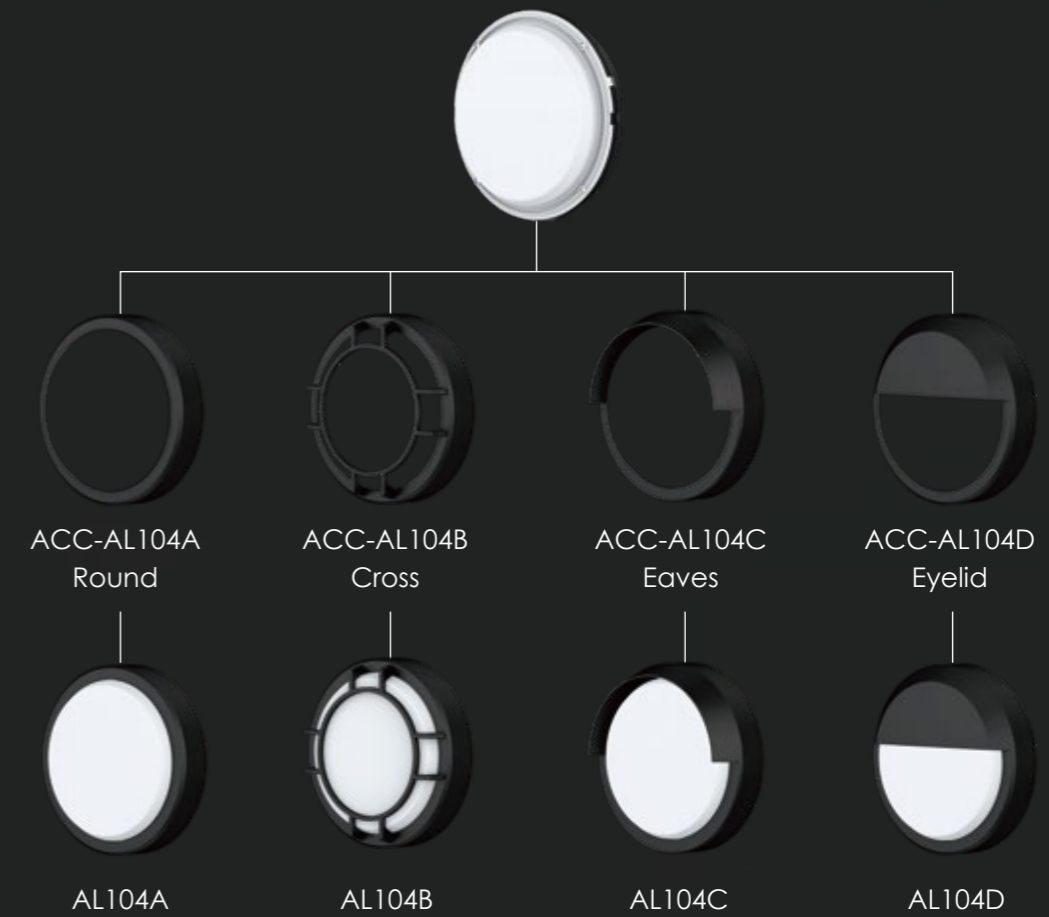

FOUR DIFFERENT TRIMS



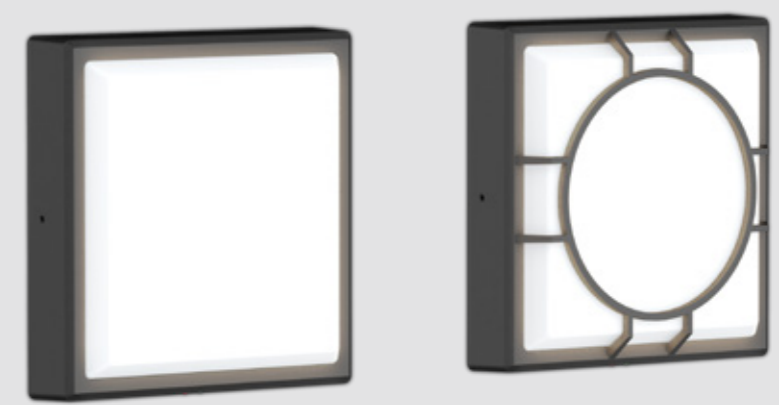
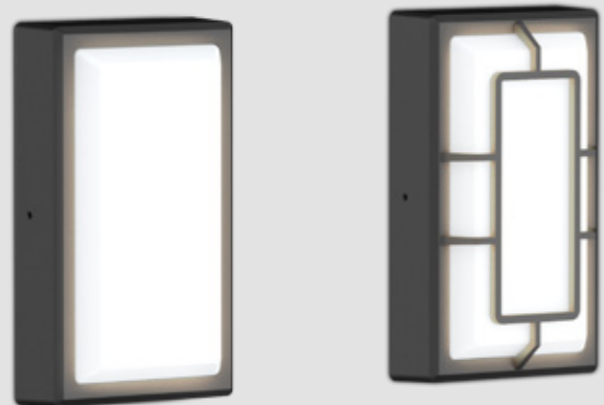

AL104R Bulkhead

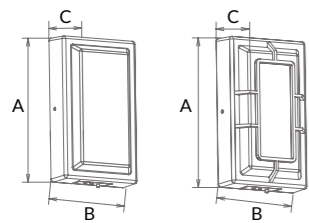

AL104R is IP65 IK10 bulkhead which adopts Die-casting Aluminum body and 94-V0 fire-rated PC cover. AL104R is rectangle. This fixture is with two different trims and provides an alternative to color changeable, sensor and emergency functions. Dali and 0-10V dimming are also available.

-
-
-
-
-
-
-
-
-
-
-
-
-
-
-
-
-
-

Code	Watt	Size(AxBxCmm)	Lumen(±5%)	N.W/pc(kgs)	Q'ty/CTN
AL104R-10-15W	15W	250x150x63	1650lm	0.90	10PCS
AL104R-10-15W	15W	250x150x69	1350lm	0.97	10PCS

CCT ——— 3000K 4000K 5000K 5700K

Ring ———

ACC-AL104RA ACC-AL104RB

Finish ——— White Black

AL104S Bulkhead

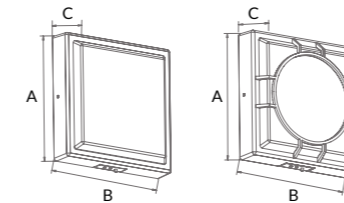

AL104S is IP65 IK10 bulkhead which adopts Die-casting Aluminum body and 94-V0 fire-rated PC cover. AL104S is square version. This fixture is with two different trims and provides an alternative to color changeable, sensor and emergency functions. Dali and 0-10V dimming are also available.

-
-
-
-
-
-
-
-
-
-
-
-
-
-
-
-
-
-

Code	Watt	Size(AxBxCmm)	Lumen(±5%)	N.W/pc(kgs)	Q'ty/CTN
AL104S-10-15W	15W	250x250x63	1780lm	0.90	10PCS
AL104S-10-15W	15W	250x250x69	1500lm	0.97	10PCS

CCT ——— 3000K 4000K 5000K 5700K

Ring ———

ACC-AL104SA ACC-AL104SB

Finish ——— White Black

LED Bulkhead



LED Track Light

/Series/

LED track light has been around for decades, yet it remains as fresh and contemporary a ceiling light fixture as ever. This is due primarily to its pure modern look, with clean, rigid tracks and streamlined directional heads. But function is also a factor when it comes to a track lighting system, with each of the selected track heads independently and easily adjustable and brightly focused. Complete track lighting kits will also allow you to have a stylish ceiling track lighting systems instantly. ELWA various track light could be your excellent choice!



TL29A/C



TL29B/D



TL29E



TL29F

TL29 Track Light /Series/





TL29A Track light

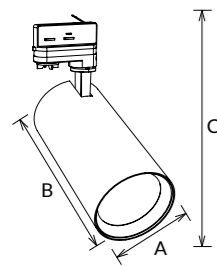

TL29A driverless track light adopts high quality brand DOB led light source, anti-glare PMMA lens with great lighting distribution, superior 6063 aluminum heat sink with great heat dissipation.

- ▶ 15° 24° 36° 350° 90° IP20
- ▶ Flicker Free
- ▶ AC 220-240V CRI≥80 CRI≥90
- ▶ SAA RoHS CE

Code	Watt	Size(AxBxCmm)	Lumen(±5%)	N.W/pc(kgs)	Q'ty/CTN
TL29A-20W	20W	Ø85x170x261	1560lm	0.55	12PCS
TL29A-30W	30W	Ø100x200x291	2550lm	0.79	12PCS
TL29A-40W	40W	Ø100x200x291	3400lm	0.79	12PCS

CCT — 2700K 3000K 4000K 5000K Finish — White Black Silver

Trim Accessories — Standard Barn Door ACC-TL29-50 Honeycomb Louver ACC-TL29-51 Cross Louver ACC-TL29-52



TL29B Track light

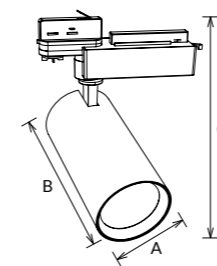

TL29B track light adopts brand Citizen COB led chip with CRI80 CRI90 CRI97 for options and AL6063 superior housing to support excellent heat dissipation. Brand Trodonic Driver available, also could be for Fresh Lighting.

- ▶ 15° 24° 36° 350° 90° IP20
- ▶ DIM Flicker Free Vivid Lighting
- ▶ AC 220-240V CRI≥80 CRI≥90 CRI≥97
- ▶ SAA RoHS CE

Code	Watt	Size(AxBxCmm)	Lumen(±5%)	N.W/pc(kgs)	Q'ty/CTN
TL29B-12W	12W	Ø65x150x188	1200lm	0.52	12PCS
TL29B-25W	25W	Ø85x170x206	2750lm	0.75	12PCS
TL29B-35W	35W	Ø85x200x206	3675lm	0.79	12PCS
TL29B-42W	42W	Ø100x200x220	4410lm	1.05	12PCS

CCT — 2700K 3000K 4000K 5000K Finish — White Black Silver

Trim Accessories — Standard Barn Door ACC-TL29-50 Honeycomb Louver ACC-TL29-51 Cross Louver ACC-TL29-52



TL29C Track light

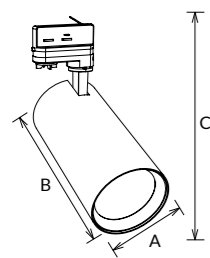

TL29C track light adopts brand Citizen COB led chip, internal driver and superior AL6063 aluminium housing with excellent heat dissipation, Standard, honeycomb, shutter different trims for options.

- ▶ 15° 24° 36° 350° 90° IP20
- ▶ DIM Flicker Free
- ▶ AC 220-240V CRI≥80 CRI≥90
- ▶ SAA RoHS CE

Code	Watt	Size(AxBxCmm)	Lumen(±5%)	N.W/pc(kgs)	Q'ty/CTN
TL29C-12W	12W	Ø65x150x243	1200lm	0.47	12PCS
TL29C-25W	25W	Ø85x200x291	2750lm	0.68	12PCS
TL29C-35W	35W	Ø100x200x291	3675lm	0.79	12PCS

CCT ——— 2700K 3000K 4000K 5000K Finish ——— White Black Silver

Trim Accessories ——— Standard Barn Door ACC-TL29-50 Honeycomb Louver ACC-TL29-51 Cross Louver ACC-TL29-52

TL29D Track light

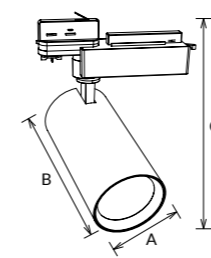

TL29D led track light is with minimalist design structure with external driver, 4 types reflectors and trim for option. It adopts high lumen SMD LED, anti-glare PC lens with great lighting distribution. Supreme 6063 aluminum heat sink provides great heat dissipation.

- ▶ 38° 350° 90° IP20
- ▶ Flicker Free SLIDE SWITCH 3 in 1
- ▶ AC 220-240V CRI≥80
- ▶ SAA RoHS CE

Code	Watt	Size(AxBxCmm)	Lumen(±5%)	N.W/pc(kgs)	Q'ty/CTN
TL29D-20W-C3	20W	Ø85x170x206	1800lm	0.75	12PCS
TL29D-30W-C3	30W	Ø85x200x206	2600lm	0.79	12PCS

CCT ——— 3000K 4000K 5700K Finish ——— White Black Silver

Trim Accessories ——— Standard Barn Door ACC-TL29-50 Honeycomb Louver ACC-TL29-51 Cross Louver ACC-TL29-52

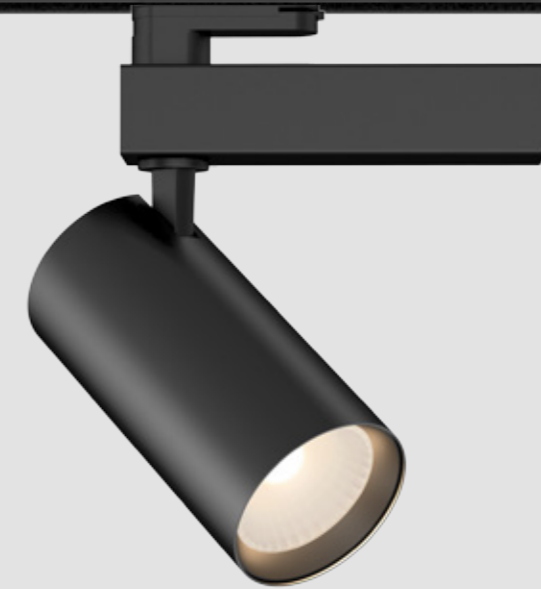

TL29E Track light

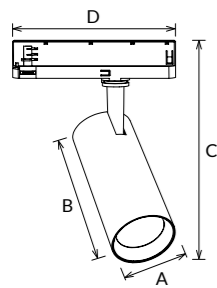

TL29E led track light is with minimalist design structure, Integrated designed of driver and adapter make the lamp with more unique appearance and longer lifespan. It adopts anti-glare PC lens with great lighting distribution and brand Citizen cob led light source. Supreme 6063 aluminum heat sink provides great heat dissipation.

- ▶ 15° 24° 36° 350° 90° IP20
- ▶ Flicker Free
- ▶ AC 220-240V CRI≥80 CRI≥90 CRI≥97
- ▶ SAA RoHS CE

Code	Watt	Size(AxBxCxDmm)	Lumen(±5%)	N.W/pc(kgs)	Q'ty/CTN
TL29E-25W	25W	Ø85x170x258x198	2750lm	0.65	12PCS
TL29E-35W	35W	Ø85x200x288x198	3675lm	0.68	12PCS

CCT ——— 2700K 3000K 4000K 5000K **Finish** ——— White Black Silver

Trim Accessories ——— Standard Barn Door ACC-TL29-50 Honeycomb Louver ACC-TL29-51 Cross Louver ACC-TL29-52

TL29F Track light

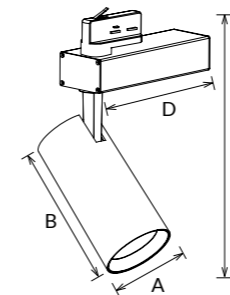

TL29F led track light is with minimalist design structure with external driver, 4 types reflectors and trim for option. It adopts anti-glare PC lens with great lighting distribution and brand Citizen cob led light source. Supreme 6063 aluminum heat sink provides great heat dissipation. Tridonic DALI solution and Citizen chip ensure reliable quality.

- ▶ 15° 24° 36° 350° 90° IP20
- ▶ DALI Flicker Free
- ▶ AC 220-240V CRI≥80 CRI≥90 CRI≥97
- ▶ SAA RoHS CE

Code	Watt	Size(AxBxCxDmm)	Lumen(±5%)	N.W/pc(kgs)	Q'ty/CTN
TL29F-25W	25W	Ø85x170x298x198	2610lm	0.90	12PCS
TL29F-35W	35W	Ø85x200x328x198	3490lm	0.95	12PCS
TL29F-42W	42W	Ø100x200x328x198	4110lm	1.20	12PCS

CCT ——— 2700K 3000K 4000K 5000K **Finish** ——— White Black Silver

Trim Accessories ——— Standard Barn Door ACC-TL29-50 Honeycomb Louver ACC-TL29-51 Cross Louver ACC-TL29-52



TL90 Track light

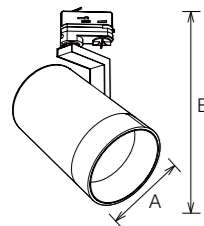

TL90 is a high-end track light with professional optic design. It adopts COB light source, special deep reflector design achieves anti-glare effect. Beside, module design provides an easily replacement with different optic part. (Two different optic part optional: reflector+tempered glass with circle lighting spot, reflector+special PC lens with oval lighting spot.) Compact appearance with big power 40W/50W, it can be rotated horizontally 358 degree, vertically 180 degree. Besides, it is a big power track light design, which meets a high brightness demand.

- ▶ 12° 24° 36° 45° 358°
- ▶ 180° IP40 UGR<19
- ▶ DALI Flicker Free 3m Slide Switch Adjustable Power
- ▶ AC 220-240V PF≥0.9 CRI≥80 CRI≥90 CRI≥97
- ▶ SAA RoHS CE

Code	Watt	Size(AxBmm)	Lumen(±5%)	N.W/pc(kgs)	Q'ty/CTN
TL90-70-15W	15W	Ø70x214	1250lm	0.54	6PCS
TL90A-90-30W-A3	20W/25W/30W	Ø90x295	20W:2100lm/25W:2400lm/30W:2750lm	1.20	6PCS
TL90A-110-40W-A3	30W/35W/40W	Ø110x294.8	30W:3200lm/35W:3600lm/40W:3800lm	1.25	6PCS
TL90A-125-50W-A3	40W/45W/50W	Ø125x315.4	40W:4000lm/45W:4400lm/50W:4700lm	1.56	6PCS
TL90B-90-30W-A3	20W/25W/30W	Ø90x280	20W:2300lm/25W:2850lm/30W:3100lm	1.20	6PCS
TL90B-110-40W-A3	30W/35W/40W	Ø110x269.8	30W:3300lm/35W:3700lm/40W:4000lm	1.25	6PCS
TL90B-125-50W-A3	40W/45W/50W	Ø125x287.4	40W:4000lm/45W:4600lm/50W:5000lm	1.56	6PCS
TL90A-110-30W-DA	30W	Ø110x294.8	2600lm	1.25	6PCS
TL90A-125-40W-DA	40W	Ø125x315.4	3500lm	1.56	6PCS
TL90B-110-30W-DA	30W	Ø110x269.8	2900lm	1.25	6PCS
TL90B-125-40W-DA	40W	Ø125x287.4	3800lm	1.56	6PCS

CCT ——— 2700K 3000K 4000K 5000K Finish ——— White Black Silver

INTERCHANGEABLE REFLECTOR AND DIFFUSER

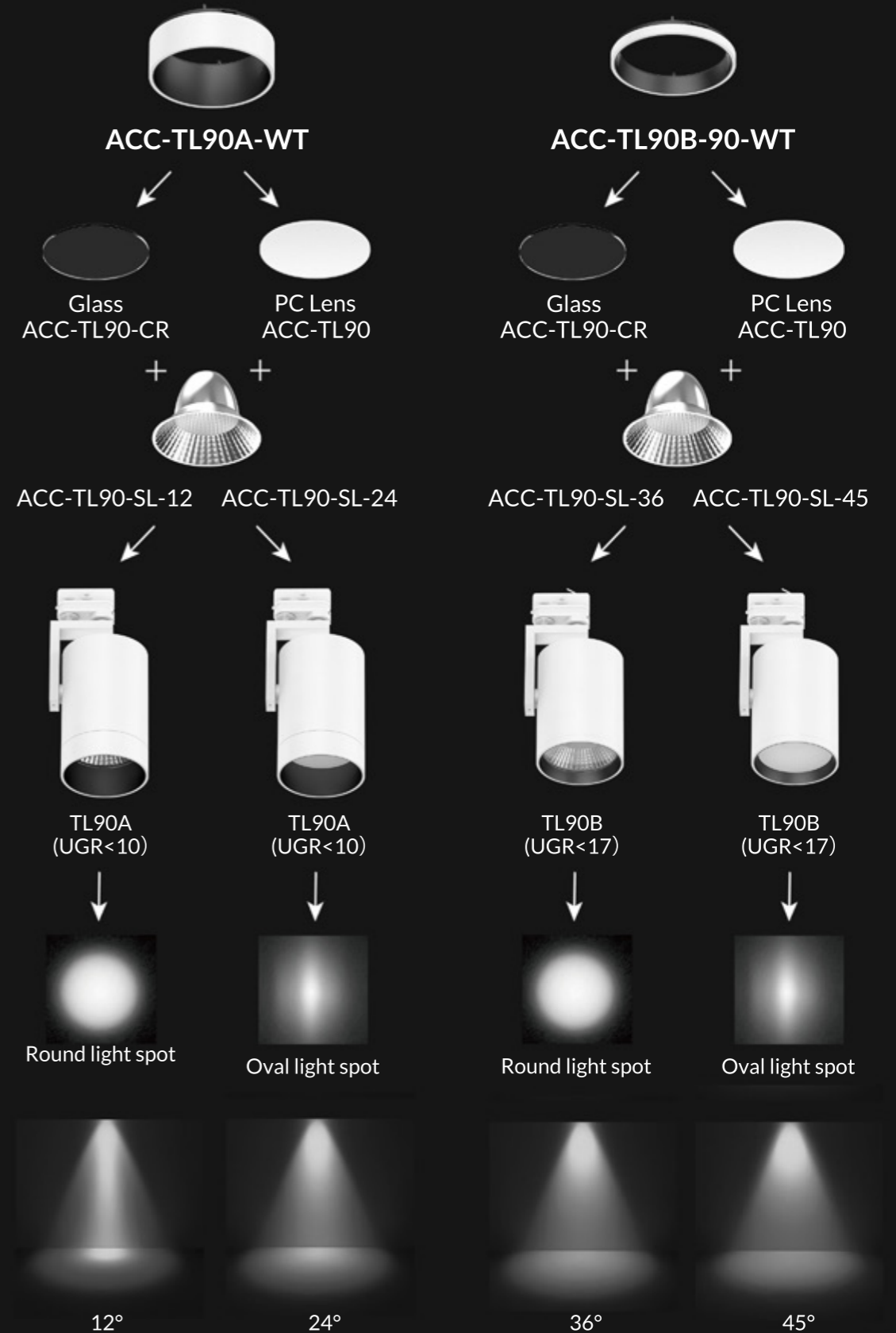



TL69A Track light

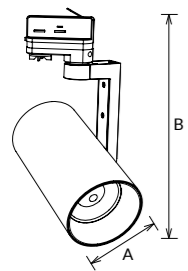

TL69 series track light with adjustable focus design, special lens can have a fast beam angle change (Just press the lens). Adopt high lumen Citizen light source, two bracket design options, changeable lighting orientation with 350° in horizontal direction and 300° in vertical direction.

- ▶ 20° 24° 36° 350° 300° IP20
- ▶ DIM Flicker Free
- ▶ AC 200-240V PF ≥ 0.9 CRI ≥ 80 CRI ≥ 90 CRI ≥ 97
- ▶ SAA RoHS CE

Code	Watt	Size(AxBmm)	Lumen(±5%)	N.W/pc(kgs)	Q'ty/CTN
TL69A-25W	25W	Ø96x298	2950lm	1.20	12PCS
TL69A-35W	35W	Ø96x298	3950lm	1.20	12PCS

TL69B Track light

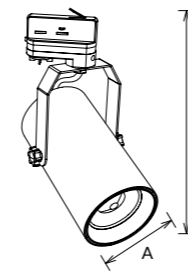

TL69B track light is with special design with lens changeable 36°~60°by press . Adopt high lumen Citizen light source effected 115lm/w .Aluminum heat sink provides excellent heat dissipation. Black and white finish color for option.

- ▶ 36° 45° 60° 350° 300° IP20
- ▶ DIM Flicker Free
- ▶ AC 200-240V PF ≥ 0.9 CRI ≥ 80 CRI ≥ 90 CRI ≥ 97
- ▶ SAA RoHS CE

Code	Watt	Size(AxBmm)	Lumen(±5%)	N.W/pc(kgs)	Q'ty/CTN
TL69B-25W	25W	Ø96x298	2950lm	1.20	12PCS
TL69B-35W	35W	Ø96x298	3950lm	1.20	12PCS



TL57A Track light

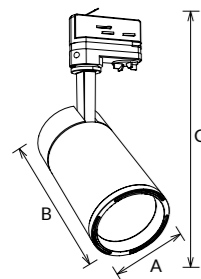

TL57A led track light is with minimalist design structure with built-in driver, it adopts brand Citizen COB chip. Supreme Aluminum heat sink provides great heat dissipation. Secondary optics with lens and reflector make more uniform light.

- Beam angles: 15°, 24°, 36°, 350°
- Adjustability: 90°
- IP Rating: IP20
- Features: DIM, Flicker Free
- Electrical: AC 220-240V, PF≥0.9, CRI≥80, CRI≥90, CRI≥97
- Certifications: SAA, RoHS, CE, CB, TÜV

Code	Watt	Size(AxBxCmm)	Lumen(±5%)	N.W/pc(kgs)	Q'ty/CTN
TL57A-10W-D	15W	Ø65x127x223	1050lm	0.51	12PCS
TL57A-25W-D	25W	Ø80x157x254	2500lm	0.81	12PCS
TL57A-35W-D	35W	Ø100x167x259	3450lm	1.03	12PCS
TL57A-15W	15W	Ø65x127x223	1600lm	0.51	12PCS
TL57A-25W	25W	Ø80x157x254	2700lm	0.81	12PCS
TL57A-35W	35W	Ø100x167x259	3800lm	1.03	12PCS

CCT: 2700K, 3000K, 4000K, 5000K | Finish: White, Black, Silver

TL58A Track light

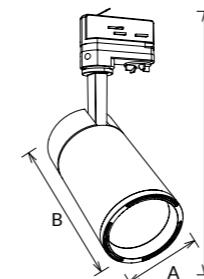

TL58A LED track light with internal driver adopts CITIZEN chips with high quality LED source, CRI80/90/97 optional. Secondary optics with lens make more uniform light. Integrated die-cast aluminum and thermal convection design provide excellent heat dissipation.

- Beam angles: 15°, 24°, 36°, 350°
- Adjustability: 90°
- IP Rating: IP20
- Features: DIM, Flicker Free
- Electrical: AC 200-240V, PF≥0.9, CRI≥80, CRI≥90, CRI≥97
- Certifications: SAA, RoHS, CE, CB, TÜV

Code	Watt	Size(AxBxCmm)	Lumen(±5%)	N.W/pc(kgs)	Q'ty/CTN
TL58A-15W	15W	Ø65x131x 227	1650lm	0.52	12PCS
TL58A-25W	25W	Ø80x152.5x249	2750lm	0.82	12PCS
TL58A-35W	35W	Ø100x167x259	3850lm	1.10	12PCS

CCT: 2700K, 3000K, 4000K, 5000K | Finish: White, Black, Silver



TL78 Track light

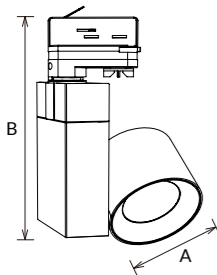

TL78 adopts Citizen COB LED chip with excellent RA to increase the color fidelity of the target illuminated object. AL6063 aluminium housing provides excellent heat dissipation. Dimming button on the bottom of the track light, DALI and 0-10V dimming available.

- ▶ 15° 24° 36° 60° 355°
- ▶ 180° IP20
- ▶ DALI 0-10V Flicker Free
- ▶ AC 200-240V PF≥0.9 CRI≥80 CRI≥90 CRI≥97
- ▶ SAA RoHS CE

Code	Watt	Size(AxBmm)	Lumen(±5%)	N.W/pc(kgs)	Q'ty/CTN
TL78-10.5W	10.5W	Ø75x179	1100lm	0.43	12PCS
TL78-20W	20W	Ø95x179	2200lm	0.54	12PCS
TL78-30W	30W	Ø115x201	3300lm	0.83	12PCS
TL78-40W	40W	Ø115x201	4400lm	0.83	12PCS

CCT — 2700K 3000K 4000K 5000K Finish — White Black Silver

TL02 Track light

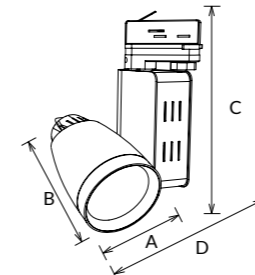

TL02 LED track light with internal driver adopts CREE/ CITIZEN branded chips, providing adjustable lighting orientation with 360 degree in horizontal direction and 180 in vertical direction.

- ▶ 15° 24° 30° 45° 60°
- ▶ 360° 180° IP20
- ▶ Flicker Free
- ▶ AC 100-240V PF≥0.9 CRI≥80 CRI≥90 CRI≥97
- ▶ SAA RoHS CE TUV

Code	Watt	Size(AxBxCxDmm)	Lumen(±5%)	N.W/pc(kgs)	Q'ty/CTN
TL02-12W	12W	Ø75x104x220x126.5	1380lm	0.70	12PCS
TL02-25W	25W	Ø90x121x233x141	2500lm	1.17	12PCS
TL02-35W	35W	Ø110x131x234x161	3600lm	1.30	8PCS
TL02-45W	45W	Ø110x131x234x161	4380lm	1.30	8PCS

CCT — 2700K 3000K 4000K 5000K Finish — White Black Silver



TL129 NEW Track light

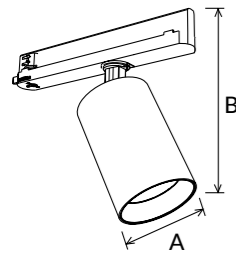

TL129 led track light is modular design with high lumen COB led, CRI80 and CRI90 both available, low glare with UGR<19, reflector is replaceable with various beam angle 12°/24°/36°/50°, CCT interchangeable, triac dim and dali dim both available.

- ▶
- ▶
- ▶
- ▶
- ▶

Code	Watt	Size(AxBmm)	Lumen(±5%)	N.W/pc(kgs)	Q'ty/CTN
TL129-65-10W	10W	Ø65x166	1200lm	0.40	24PCS
TL129-65-15W	15W	Ø65x166	1800lm	0.40	24PCS
TL129-85-20W	20W	Ø85x211	2400lm	0.70	12PCS
TL129-85-25W	25W	Ø85x211	3000lm	0.70	12PCS
TL129-85-30W	30W	Ø85x211	3600lm	0.70	12PCS

CCT — 2700K — 3000K — 4000K — 5000K

Finish — White Black

TL127 NEW Track light

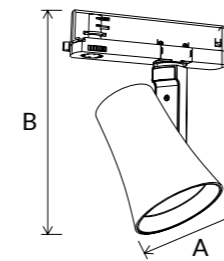

This track light using high-lumen COB chip, the design presents a contrast and harmonious appearance, the aluminum lamp body makes excellent heat dissipation, multi-beam Angle reflector, modular design, easy to replace. Track installation, suitable for clothing stores, hotels, exhibition rooms and other indoor commercial lighting.

- ▶
- ▶
- ▶
- ▶
- ▶

Code	Watt	Size(AxBmm)	Lumen(±5%)	N.W/pc(kgs)	Q'ty/CTN
TL127-86-16W	16W	Ø86x198	2200lm	0.44	12PCS
TL127-86-25W	25W	Ø86x198	3100lm	0.44	12PCS
TL127-97-25W	25W	Ø97x210	3100lm	0.56	12PCS
TL127-97-35W	35W	Ø97x210	4300lm	0.56	12PCS

CCT — 2700K — 3000K — 4000K — 5000K

Finish — White Black Nickel

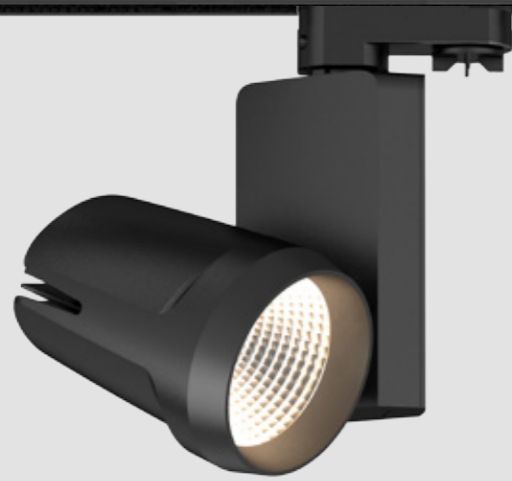

TL25 Track light

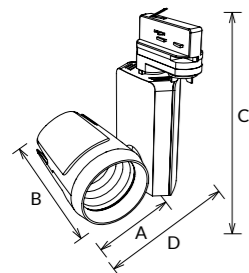

TL25 LED track light with dimming button on the bottom of the track light adopts CITIZEN LED, adjustable lighting orientation with 360 degree in horizontal direction and 180 in vertical direction, 1-circuit adapter, 3-circuit adapter available for wide choice.

- ▶ 15° 24° 36° 45° 360°
- ▶ 180° IP20
- ▶ DIM Flicker Free
- ▶ AC 220-240V CRI≥80 CRI≥90 CRI≥97
- ▶ SAA RoHS CE

Code	Watt	Size(AxBxCxDmm)	Lumen(±5%)	N.W/pc(kgs)	Q'ty/CTN
TL25-15W	15W	Ø68x83x170x102	1470lm	0.38	18PCS
TL25-25W	25W	Ø90x118.5x215x146	2600lm	0.68	12PCS
TL25-35W	35W	Ø105x128x215x161	3600lm	0.85	12PCS
TL25-45W	45W	Ø105x128x215x161	4410lm	0.85	12PCS

CCT ——— 2700K 3000K 4000K 5000K Finish ——— White Black Silver

Dimming button (100% down to 5%) ———



TL25B Track light

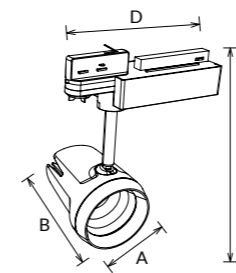

TL25B LED track light adopts CITIZEN LED, adjustable lighting orientation with 360 degree in horizontal direction and 180 in vertical direction and 1-circuit adapter, 3-circuit adapter available for wide choice.

- ▶ 15° 24° 36° 360° 180° IP20
- ▶ Flicker Free
- ▶ AC 220-240V CRI≥80 CRI≥90 CRI≥97
- ▶ SAA RoHS CE

Code	Watt	Size(AxBxCxDmm)	Lumen(±5%)	N.W/pc(kgs)	Q'ty/CTN
TL25B-25W	25W	Ø90x118x247x207	2600lm	0.75	12PCS
TL25B-35W	35W	Ø105x128x262x207	3600lm	0.92	12PCS
TL25B-45W	45W	Ø105x128x262x207	4410lm	0.92	12PCS

CCT ——— 2700K 3000K 4000K 5000K Finish ——— White Black Silver



TL120 NEW Track light

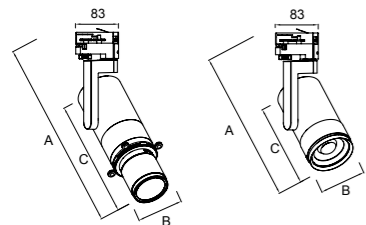

TL120 is a track spotlight with versatility and a high degree of flexibility in terms of combination, adopts high CRI COB light source, die-cast aluminum lamp body provides superior heat dissipation. It can be horizontally rotated up to 350 degrees and vertically tilted up to 180 degrees, allowing for versatile lighting angles and directions, CCT interchangeable is available. TL120A is dry damping design, TL120B adopt stepless zooming technology.

- ▶
- ▶
- ▶
- ▶
- ▶

Code	Watt	Size(AxBxCmm)	Lumen(±5%)	N.W/pc(kgs)	Q'ty/CTN
TL120A-30W-P3/D	30W	360x88.9x267	787lm	1.86	6PCS
TL120B-30W-P3/D	30W	263x92x170	2661lm	1.19	6PCS

CCT ——— 2700K ——— 3000K ——— 4000K ——— 5000K

Finish ——— White Black

DIY MODULE



TL120A

Optical-grade variable aperture design



Multi-layer dry damping design



Color



Projection

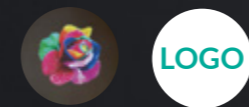

TL120B

ZOOM lens



Four-blade baffle



Stretch optics



360° manual rotation design





TL56 Track light

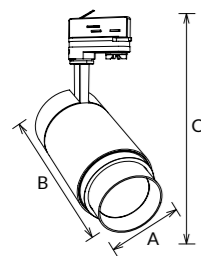

TL56 LED track light is a unique beam angle adjustable(15°-60°) design, adopt high lumen CITIZEN COB chip, flicker-free driver. Dimmable is available. Aluminum housing and cross-ventilated design ensure a excellent heat management.

- ▶ 15°-60°
- ▶ 350°
- ▶ 90°
- ▶ IP20
- ▶ DIM
- ▶ Flicker Free
- ▶ SLEW SWITCH 3 in 1
- ▶ Bluetooth
- ▶ CASAMBI
- ▶ AC 220-240V
- ▶ PF≥0.9
- ▶ CRI≥80
- ▶ CRI≥90
- ▶ CRI≥97
- ▶ SAA
- ▶ RoHS
- ▶ CE
- ▶ CB
- ▶ TUV

Code	Watt	Size(AxBxCmm)	Lumen(±5%)	N.W/pc(kgs)	Q'ty/CTN
TL56-15W	15W	Ø65x137x234	1500lm	0.69	12PCS
TL56-25W	25W	Ø80x163x260	2500lm	0.91	12PCS
TL56-30W	30W	Ø100x173x265	3000lm	1.29	12PCS

CCT — 2700K 3000K 4000K 5000K Finish — White Black Silver

TL17 Track light

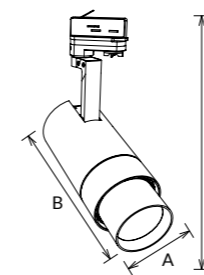

By using advancing zooming technology, TL17 LED tracklight have a flexible beam angle from 10° to 60°. Flicker free LED driver. Dimmable for option.

- ▶ 10°-60°
- ▶ 320°
- ▶ 90°
- ▶ IP20
- ▶ DIM
- ▶ Flicker Free
- ▶ AC 200-240V
- ▶ PF≥0.9
- ▶ CRI≥80
- ▶ CRI≥90
- ▶ CRI≥97
- ▶ SAA
- ▶ RoHS
- ▶ CE

Code	Watt	Size(AxBxCmm)	Lumen(±5%)	N.W/pc(kgs)	Q'ty/CTN
TL17-35W	35W	Ø100x207x301	1790~3720lm	1.53	6PCS

CCT — 2700K 3000K 4000K 5000K Finish — White Black Silver



TL79 Track light

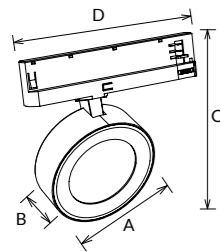

TL79 track light is an integrated design with internal driver and 3 circuit adapter. It is with interchangeable lens 15°/24°/36°/60° and Replaceable rings Black/White/Gold/Silver.

- ▶ 15° 24° 36° 60° 350°
- ▶ 90° IP20
- ▶ DALI Flicker Free CASAMBI
- ▶ AC 200-240V CRI ≥ 80
- ▶ SAA RoHS CE

Code	Watt	Size(AxBxCxDmm)	Lumen(±5%)	N.W/pc(kgs)	Q'ty/CTN
TL79-10W	10W	Ø90x43x146x196	1250lm	0.44	12PCS
TL79-18W	18W	Ø90x43x146x196	2150lm	0.44	12PCS
TL79-25W	25W	Ø120x43x178x207	2950lm	0.61	12PCS
TL79-30W	30W	Ø120x43x178x207	3350lm	0.61	12PCS
TL79-13W-DA	13W	Ø90x43x146x265	1600lm	0.52	12PCS
TL79-20W-DA	20W	Ø90x43x146x265	2300lm	0.52	12PCS
TL79-25W-DA	25W	Ø120x43x176x260	2650lm	0.65	12PCS
TL79-30W-DA	30W	Ø120x43x178x260	3200lm	0.65	12PCS

CCT ——— 2700K 3000K 4000K 5000K Trim ——— White Black Silver Golden



60°
ACC-TL79-15

36°
ACC-TL79-15

24°
ACC-TL79-15

15°
ACC-TL79-15

Black
ACC-TL79-BK

White
ACC-TL79-WT

Silver
ACC-TL79-SL

Gold
ACC-TL79-GD

INTERCHANGEABLE lens and trim



TL40B Track light

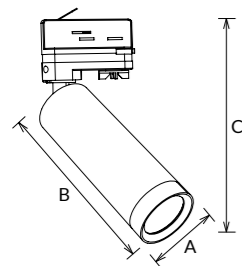

TL40B led track light adopts Citizen chip which can create a diversified and dramatic atmosphere. Adjustable lighting orientation with 350° in horizontal direction and 90° in vertical direction will bring a flexible exposure. 1-circuit and 3-circuit are all available.

- ▶ 15° 24° 36°
- ▶ 350° 90°
- ▶ IP20
- ▶ DIM Flicker Free
- ▶ AC 220-240V CRI≥80 CRI≥90 CRI≥97
- ▶ SAA RoHS CE

Code	Watt	Size(AxBxCmm)	Lumen(±5%)	N.W/pc(kgs)	Q'ty/CTN
TL40B-10W	10W	Ø54x162x236	1000lm	0.45	24PCS
TL40B-12W	12W	Ø54x162x236	1200lm	0.45	24PCS

CCT 2700K 3000K 4000K 5000K

Finish White Black Silver

TL119 ^{NEW} Track light

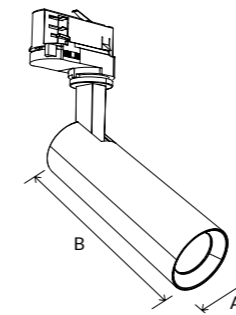

TL119 track light adopts brand cob led chip, internal driver and superior AL6063 aluminum profile provides excellent thermal dissipation, various optics for option. Triac dimmable and 3CCT interchangeable are available.

- ▶ 24° 30° 38° 45° 60°
- ▶ 350° 90°
- ▶ IP20
- ▶ DIM Flicker Free SLIDE SWITCH 3 in 1
- ▶ AC 220-240V PF≥0.9 CRI≥80 CRI≥90
- ▶ SAA RoHS CE

Code	Watt	Size(AxBmm)	Lumen(±5%)	N.W/pc(kgs)	Q'ty/CTN
TL119-47-10W	10W	Ø47x241	1150lm	0.34	12PCS
TL119-68-20W	20W	Ø68x268	2150lm	0.60	12PCS
TL119-68-25W	25W	Ø68x268	2650lm	0.63	12PCS
TL119-75-25W	25W	Ø75x286	2750lm	0.65	12PCS
TL119-75-30W	30W	Ø75x286	3100lm	0.72	12PCS

CCT 2700K 3000K 4000K 5000K

Finish White Black Silver

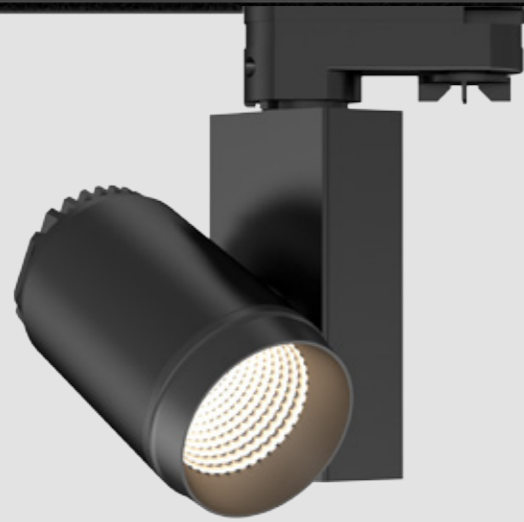

TL16 Track light

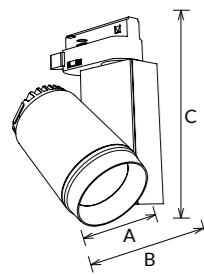

TL16 patent mini track lights with high CRI high lumen CITIZEN COB led chip to enhance color fidelity target illumination object. both non-dimmable and triac dimmable can be available, triac dimmable can be compatible with global brand dimmer.

- ▶ 15° 24° 36° 60° 360°
- ▶ 180° IP20
- ▶ DIM Flicker Free
- ▶ AC 100-240V PF ≥ 0.9 CRI ≥ 80
- ▶ SAA RoHS CE

Code	Watt	Size(AxBxCmm)	Lumen(±5%)	N.W/pc(kgs)	Q'ty/CTN
TL16-12W	12W	62x100x182	1350lm	0.46	20PCS

CCT 2700K 3000K 4000K 5000K **Finish** White Black Silver

TL14 Track light

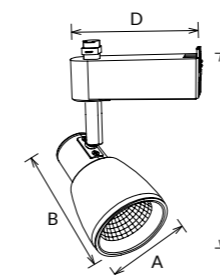

TL14 ceiling spotlight adopts die-casting ADC12 with excellent heat management. Dimmable available for wide choice. Adjustable lighting orientation with 350 degree in horizontal direction and 35 in vertical direction provided.

- ▶ 24° 36° 45° 60° 350°
- ▶ 35° IP20
- ▶ DIM Flicker Free
- ▶ AC 200-240V PF ≥ 0.9 CRI ≥ 80
- ▶ SAA RoHS CE

Code	Watt	Size(AxBxCxDmm)	Lumen(±5%)	N.W/pc(kgs)	Q'ty/CTN
TL14-10W	10W	65x97.5x145x102	800lm	0.30	36PCS

CCT 2700K 3000K 4000K 5000K **Finish** White Black Silver



TL62 Track light

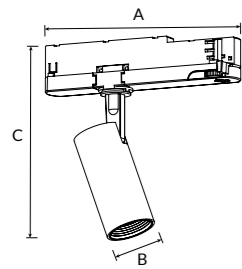

TL62 series has a tiny body with integrate driver, ADC12 aluminum housing provides excellent heat dissipation. 5 installation ways of track, recessed, surface mounted. High CRI90 for more real light and adopt universal track adaptor. Adjustable lighting orientation with 350° in horizontal direction and 90° in vertical direction.

- ▶ 36° 350° 90° IP20
- ▶ DIM Flicker Free
- ▶ AC 200-240V PF≥0.9 CRI≥90
- ▶ SAA RoHS CE

Code	Watt	Size(AxBmm)	Cut-out(mm)	Lumen(±5%)	N.W/pc(kgs)	Q'ty/CTN
TL62B-8W-D	8W	85x177x46	-	550lm	0.30	24PCS
TL62C-8W-D	8W	105x185	90-95	550lm	0.35	12PCS
TL62D-8W-D	1x8W	90x175	-	550lm	0.35	24PCS
TL62D-16W-D	2x8W	240x175	-	1050lm	0.95	12PCS
TL62D-24W-D	3x8W	240x175	-	1600lm	1.19	12PCS
ACC-TL62	-	42x20	-	-	0.006	120PCS

CCT ——— 2700K 3000K 4000K 5000K **Finish** ——— White Black Silver

Trim Accessories ——— ACC-TL62-BK ACC-TL62-WT ACC-TL62-GD

MINI TUBE SPOTLIGHT



Interchangeable color front ring

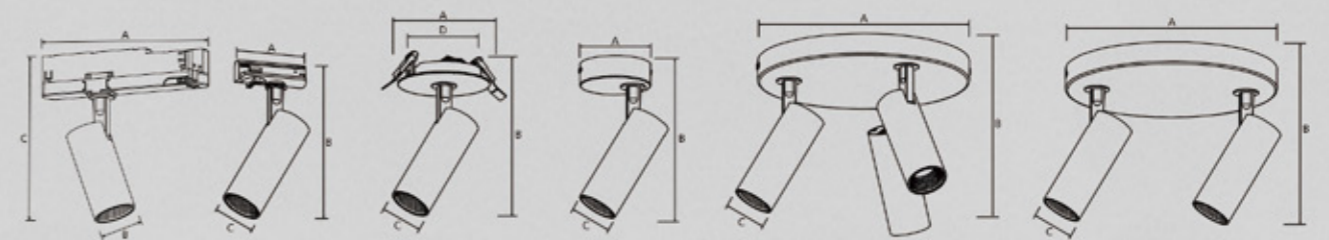

TL62 TL62B TL62C TL62D-8W TL62D-24W TL62D-16W

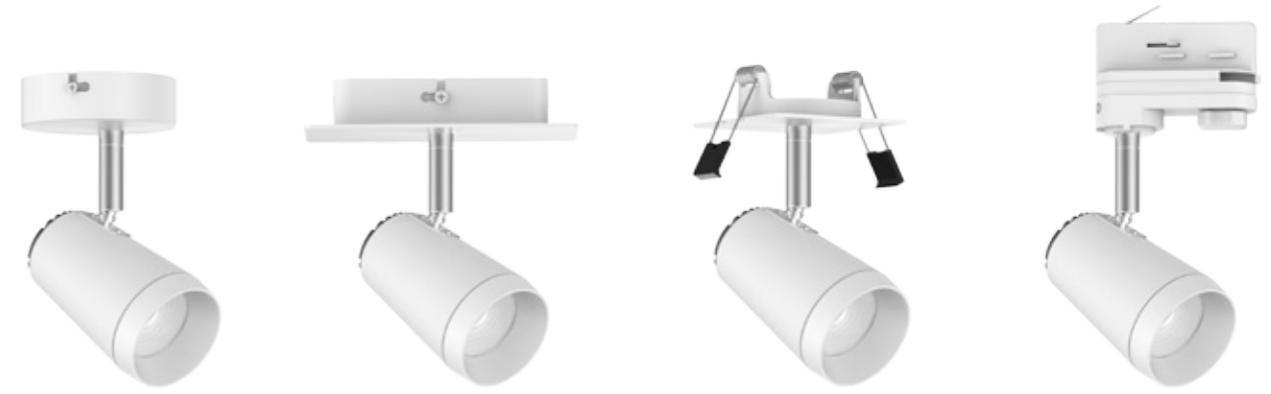

TL19A

TL19B

TL19C

TL19D

TL19 Track light

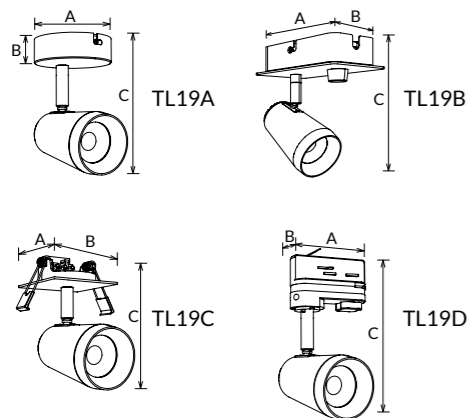

- ▶ 36° 60° 340° 90° IP20
- ▶ DIM Flicker Free
- ▶ AC 100-240V AC 200-240V PF≥0.9 CRI≥80
- ▶ SAA RoHS CE

TL19 surface mounred ceiling spotlight adopts die-casting ADC12 with excellent heat management. Dimmable available for wide choice. Adjustable lighting orientation with 350 degree in horizontal direction and 35 in vertical direction provided.

Code	Watt	Size(AxBxCmm)	Lumen(±5%)	N.W/pc(kgs)	Q'ty/CTN
TL19A-10W	10W	Ø80x25x158	1055lm	0.28	24PCS
TL19A-20W	20W	Ø240x25x158	2110lm	0.84	12PCS
TL19A-30W	30W	Ø240x25x158	3165lm	1.02	12PCS
TL19B-10W	10W	140x80x160	1055lm	0.48	24PCS
TL19B-20W	20W	250x80x160	2110lm	0.90	12PCS
TL19B-30W	30W	370x80x160	3165lm	1.28	12PCS
TL19C-10W	10W	78x78x167	1055lm	0.28	24PCS
TL19D-10W	10W	85x32x175	1055lm	0.28	24PCS



CCT ——— 2700K 3000K 4000K 5000K **Finish** ——— White Black Silver



TL49 Track light

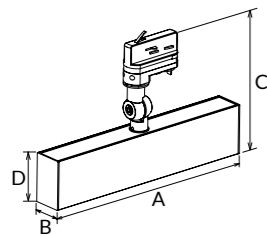

TL49 LED linear track light with louver reflector design. It's widely used as additional lighting compared with traditional spot track light. Adopt 2835SMD chip, louver reflector make it anti-glare, 6063 aluminum provides good heat dissipation. Adjustable lighting orientation with 350° in horizontal direction and 220° in vertical direction.

- ▶ 60° 350° 220° IP20 UGR<19
- ▶ Flicker Free
- ▶ AC 220-240V PF≥0.9 CRI≥80
- ▶ SAA RoHS CE

Code	Watt	Size(AxBxCxDmm)	Lumen(±5%)	N.W/pc(kgs)	Q'ty/CTN
TL49-15W	15W	319.5x42x195.5x70	1400lm	0.74	12PCS
TL49-30W	30W	424.5x42x195.5x70	2750lm	0.92	12PCS
TL49-37W	37W	529.5x42x195.5x70	3400lm	1.15	12PCS
TL49-45W	45W	529.5x42x195.5x70	3850lm	1.15	12PCS

CCT — 3000K 4000K 5000K 5700K Finish — White Black Silver

TL110 Track light

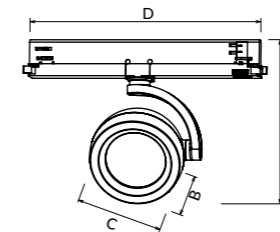

TL110 is a compact and exquisite track light. It adopts high lumen branded COB light source, special texture designed lens lowered glare to create a comfortable visual experience. The lamp body is an innovative honeycomb-shaped aluminum housing, which has good heat dissipation performance. Horizontally and vertically 350 degree rotation can be freely adjusted.

- ▶ 20° 30° 45° 60° 350°
- ▶ 350° IP20
- ▶ Flicker Free
- ▶ AC 220-240V PF≥0.9 CRI≥80
- ▶ SAA RoHS CE

Code	Watt	Size(AxBxCmm)	Lumen(±5%)	N.W/pc(kgs)	Q'ty/CTN
TL110-20W	20W	158x180x74	2350lm	0.63	12PCS
TL110-30W	30W	250x180x74	3400lm	0.67	12PCS

CCT — 2700K 3000K 4000K 5000K Finish — White Black Silver

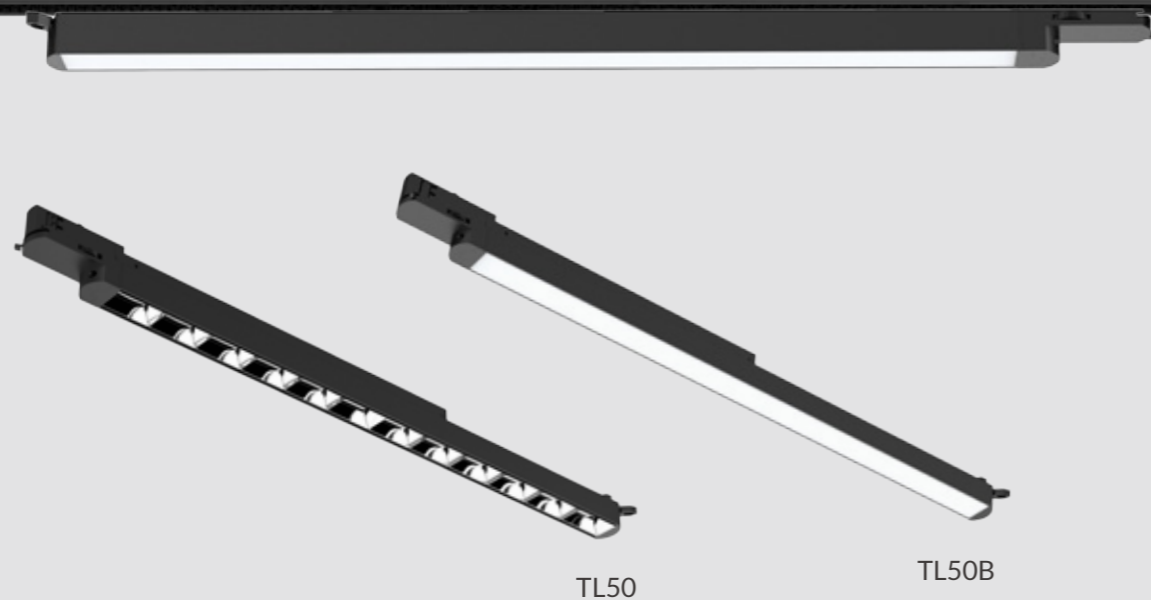

TL50

TL50B



TL50/B Track light

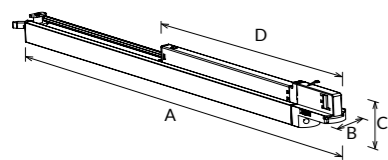

TL50 LED linear track light is a concise design with internal flicker free led driver. Adopting high lumen efficiency SMD LED. Aluminum lamp body and reflector provide excellent heat management. Interchangeable CCT with slide switch is available.

- ▶ 110° IP20
- ▶ Flicker Free SLIDE SWITCH 3 in 1
- ▶ AC 220-240V PF≥0.9 CRI≥80
- ▶ SAA RoHS CE

Code	Watt	Size(AxBxCxDmm)	Lumen(±5%)	N.W/pc(kgs)	Q'ty/CTN
TL50/B-10W	10W	650x32.5x52x436	1000lm	0.43	12PCS
TL50/B-16W	16W	650x32.5x52x436	1560lm	0.45	12PCS
TL50/B-25W	25W	1212x32.5x52x496	2550lm	0.76	12PCS
TL50/B-30W	30W	1212x32.5x52x496	3000lm	0.76	12PCS
TL50/B-30W	30W	1493x32.5x52x496	3000lm	0.92	12PCS

CCT — 3000K 4000K 5000K 5700K Finish — White Black Silver

TL109 Track light

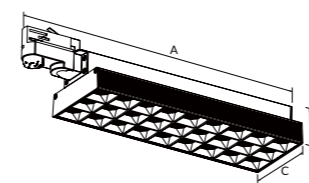

This is a newly design track light with both high lumen efficiency and low UGR. It adopts super high lumen SMD light source, combine with honeycomb optic reflector to reach a low UGR<19. Standard European 3 circuits track and multiple beam angles for options.

- ▶ 15° 24° 36° 45° 35°x70° IP20
- ▶ Flicker Free
- ▶ AC 200-240V PF≥0.9 CRI≥80
- ▶ SAA RoHS CE

Code	Watt	Size(AxBxCmm)	Lumen(±5%)	N.W/pc(kgs)	Q'ty/CTN
TL109-52W	52W	435x123x96	7000lm	1.62	6PCS

CCT — 3000K 4000K 5000K 5700K Finish — White Black

LED Track light

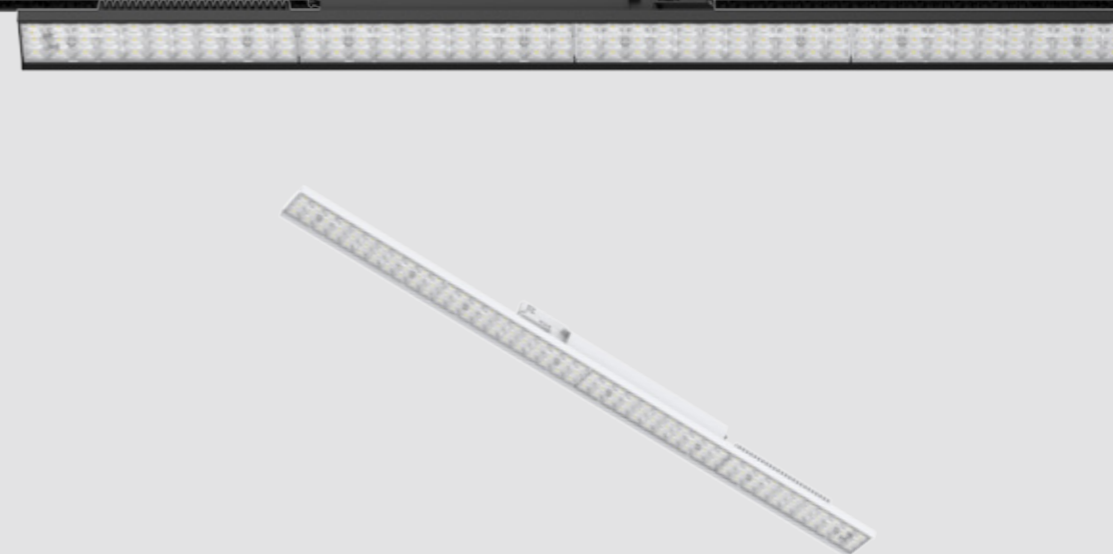
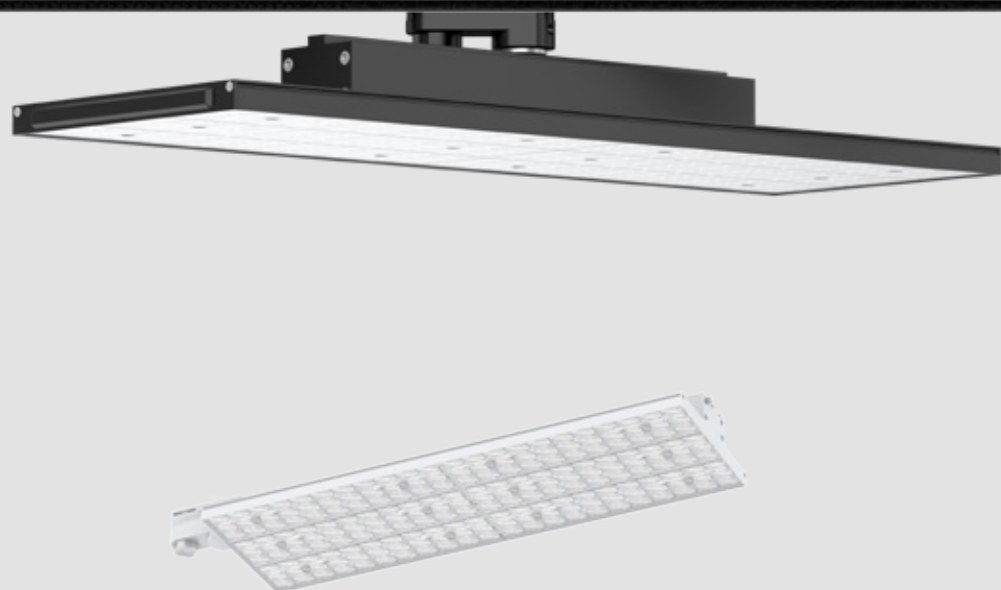

TL111 Track light

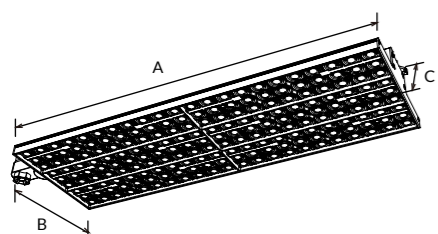

TL111 LED track light is specifically designed for supermarket aisles. Type A with an adapter at the side while type B with adapter at the back and can do 350 degree rotary. It adpots PMMA lens and high brand Osram driver which provides long lifespan, and European standard three-circuit track system is suitable. High lumen efficiency 130-140lm/W is available.

- ▶ 30° 60° 90° Double Asymmetric 20° 350°
- ▶ IP20
- ▶ Flicker Free
- ▶ AC 220-240V PF≥0.9 CRI≥80
- ▶ SAA RoHS CE

Code	Watt	Size(AxBxCmm)	Lumen(±5%)	N.W/pc(kgs)	Q'ty/CTN
TL111A-50W	50W	670x190x80	7040lm	2.50	6PCS
TL111A-60W	60W	670x190x80	8250lm	2.50	6PCS
TL111A-80W	80W	670x190x80	10480lm	2.50	6PCS
TL111B-50W	50W	582x190x116	7040lm	2.50	6PCS
TL111B-60W	60W	582x190x116	8250lm	2.50	6PCS
TL111B-80W	80W	582x190x116	10480lm	2.50	6PCS

CCT — 3000K 4000K 5000K 5700K Finish — White Black

TL112 Track light

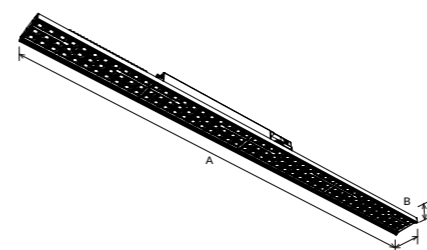

TL112 a new seamless linear track lighting system, which has thin body, light weight and compact structure, suitable for European standard three-circuit track system. Multiple PMMA lens optics 30°, 60°, 90°, double asymmetric 20° for options. AL6063 aluminum housing offers a great thermal management and ensure a long lifespan.

- ▶ 30° 60° 90° Double Asymmetric 20° IP20
- ▶ Flicker Free
- ▶ AC 220-240V PF≥0.9 CRI≥80
- ▶ SAA RoHS CE

Code	Watt	Size(AxBxCmm)	Lumen(±5%)	N.W/pc(kgs)	Q'ty/CTN
TL112-40W	40W	1152x80x85	5100lm	2.17	6PCS
TL112-60W	60W	1152x80x85	7150lm	2.17	6PCS

CCT — 3000K 4000K 5000K 5700K Finish — White Black

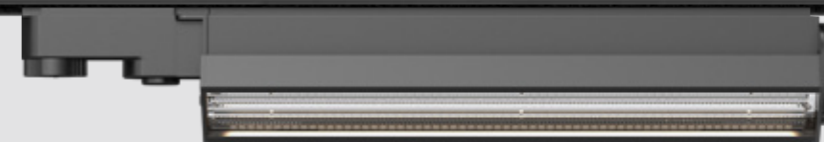
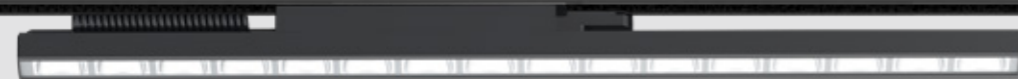

TL113 Track light

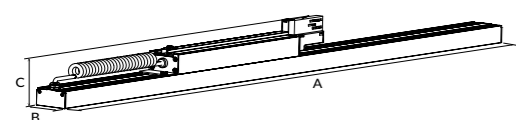

TL113 a new seamless linear track lighting system, which has thin body, light weight and compact structure, suitable for European standard three-circuit track system. Optic design combines with diffuser and reflector, which make more uniform light output. With high quality Osram brand driver and aluminum housing, it can have a great thermal management and ensure a long lifespan.

- ▶ 30°x60° 60°x90° IP20
- ▶ Flicker Free
- ▶ AC 220-240V PF≥0.9 CRI≥80
- ▶ SAA RoHS CE

Code	Watt	Size(AxBxCmm)	Lumen(±5%)	N.W/pc(kgs)	Q'ty/CTN
TL113-47W	47W	1142x60x98	6300lm	2.05	6PCS
TL113-63W	63W	1142x60x98	8550lm	2.05	6PCS

CCT — 3000K 4000K 5000K 5700K Finish — White Black

TL114 Track light

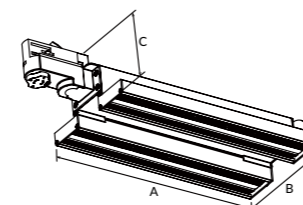

TL114 is designed specifically for supermarket aisles, shelves, corridors etc. The light source is divided into left and right parts, which can be rotated upwards by 90°. The unique structural design allows the product to fit different aisle widths and installation heights with high flexibility. A great compatibility with European standard 3-circuit track and convenient for group control.

- ▶ 60°x90° 90°x100° 90° IP20
- ▶ Flicker Free
- ▶ AC 220-240V PF≥0.9 CRI≥80
- ▶ SAA RoHS CE

Code	Watt	Size(AxBxCmm)	Lumen(±5%)	N.W/pc(kgs)	Q'ty/CTN
TL114-57W	57W	416x135x60	7100lm	1.2	6PCS

CCT — 3000K 4000K 5000K 5700K Finish — White Black

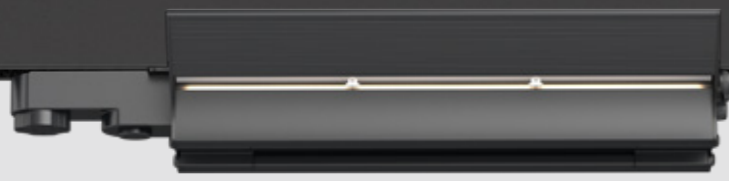

TL115 Track light

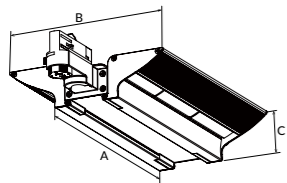

TL115 is a two-wing bionic design and has a unique rectangular light distribution that guides users eyes to the shelf. At the same time, the illumination on the ground will not be too high, which can greatly improve the utilization rate of light and reduce energy consumption. The wings can be tilted downward by 30°, which is convenient to adjust the beam angle and meet the requirements of different aisle widths and installation heights.

- ▶ 60°x90° 90°x100° 30° IP20
- ▶ DIM Flicker Free
- ▶ AC 200-240V PF≥0.9 CRI≥80
- ▶ SAA RoHS CE

Code	Watt	Size(AxBxCmm)	Lumen(±5%)	N.W/pc(kgs)	Q'ty/CTN
TL115-57W	57W	388x218x70	5500lm	1.52	6PCS

CCT ——— 3000K 4000K 5000K 5700K ——— Finish ——— White Black

Angel's Wings

Multiple beam angle options:

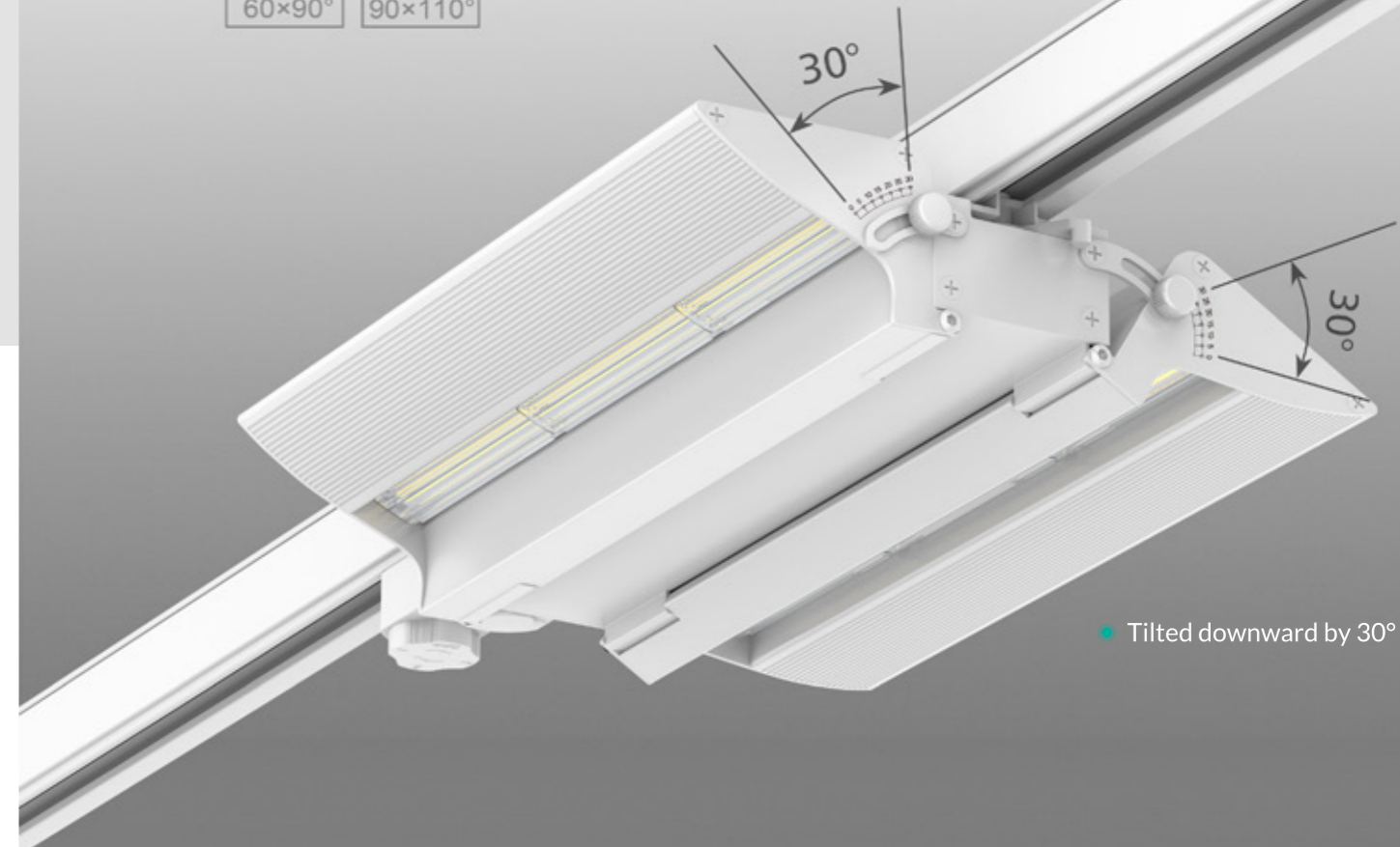

● Tilted downward by 30°

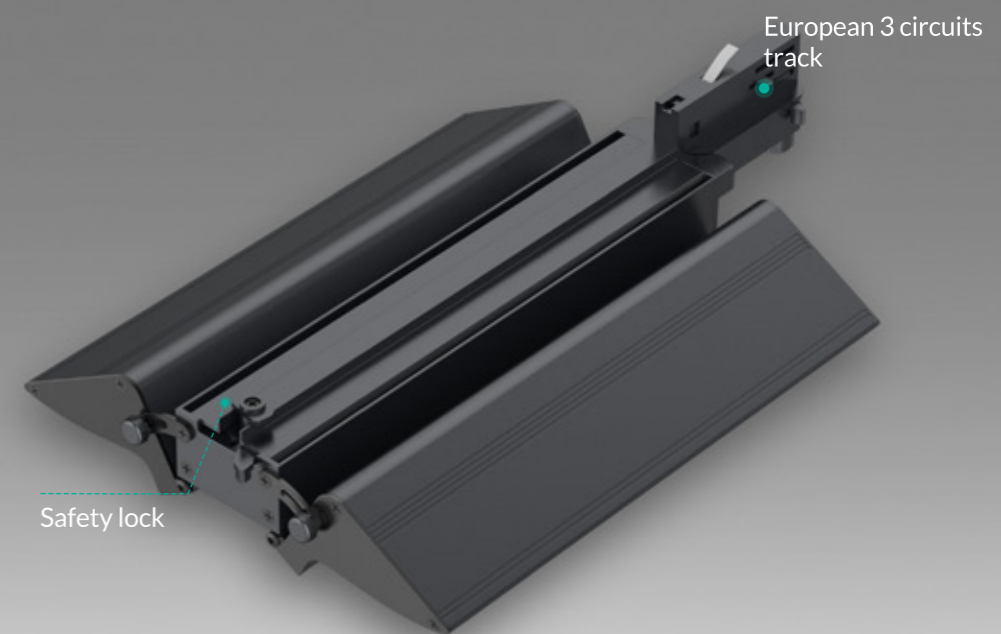
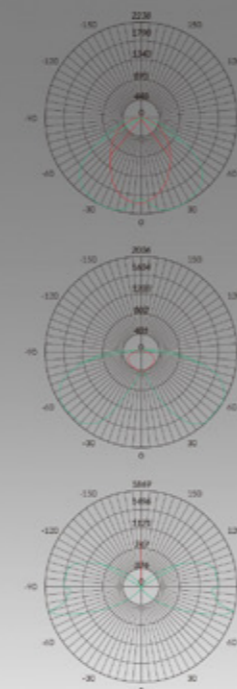

Safety lock

European 3 circuits track

Track System

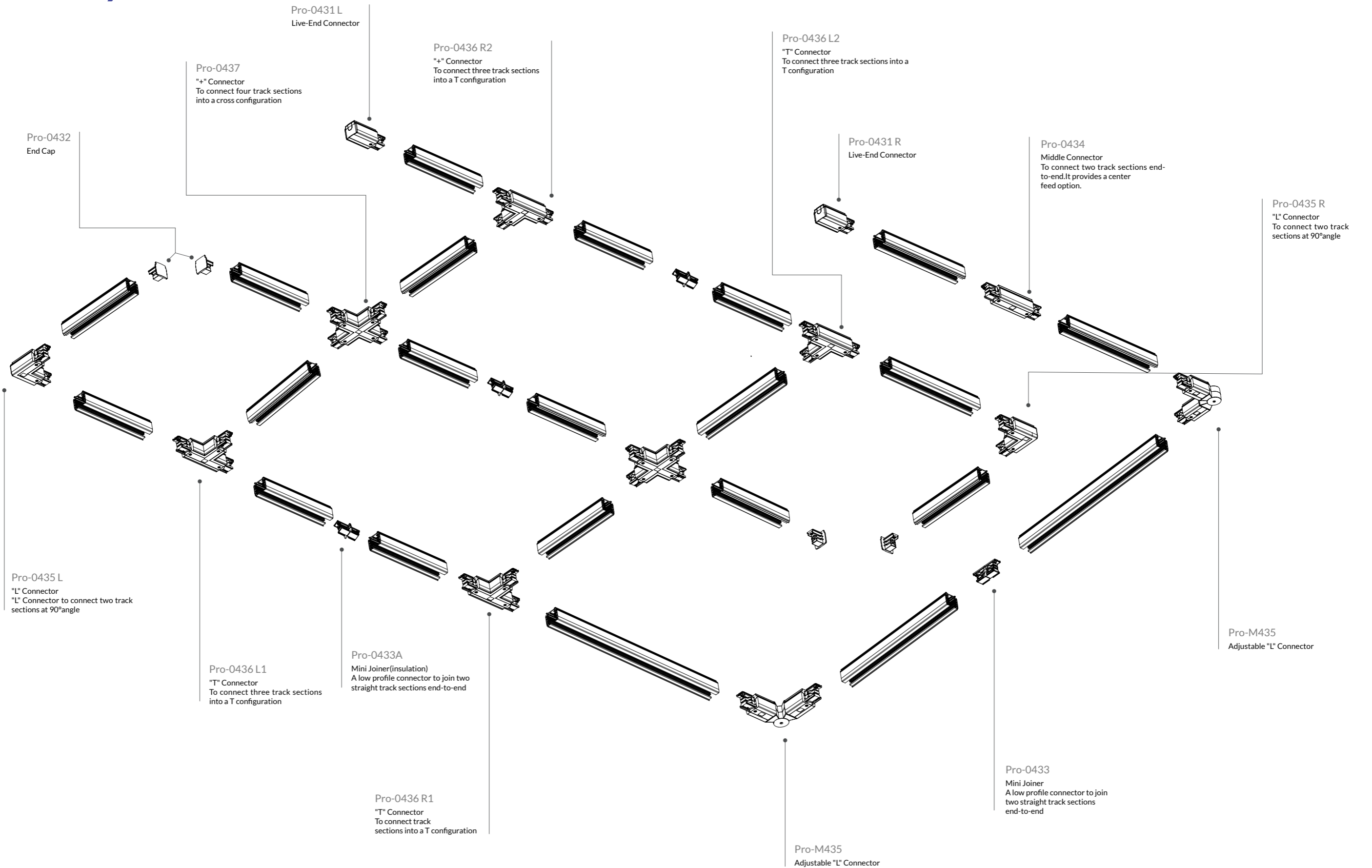

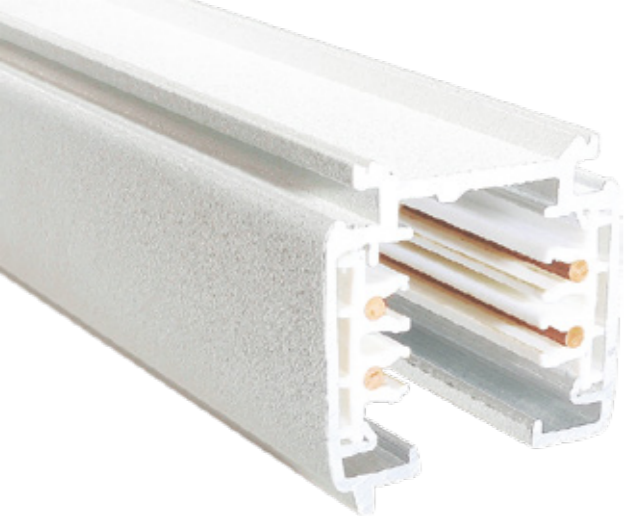

3 Circuits Track System

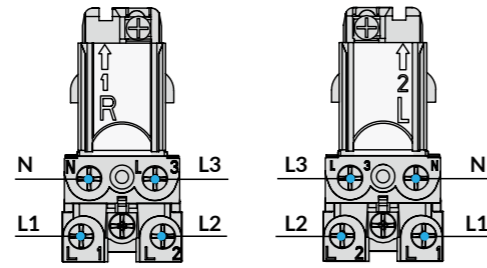
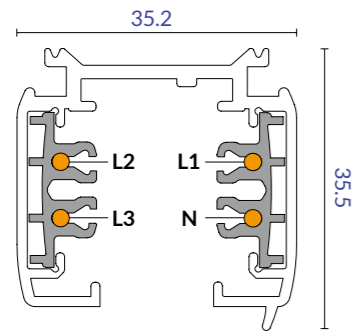

Model No.	Track length	Shell Material	Colour	Package
Pro-0410-W / Pro-0410-S / Pro-0410-B	1M track actual one meter.(100cm)	Aluminum Extrusion	White <input type="checkbox"/> Silver <input type="checkbox"/> Black <input type="checkbox"/>	1 / 12
Pro-0415-W / Pro-0415-S / Pro-0415-B	1.5M track actual one meter.(150cm)	Aluminum Extrusion	White <input type="checkbox"/> Silver <input type="checkbox"/> Black <input type="checkbox"/>	1 / 12
Pro-0420-W / Pro-0420-S / Pro-0420-B	2M track actual one meter.(200cm)	Aluminum Extrusion	White <input type="checkbox"/> Silver <input type="checkbox"/> Black <input type="checkbox"/>	1 / 12
Pro-0430-W / Pro-0430-S / Pro-0430-B	3M track actual one meter.(300cm)	Aluminum Extrusion	White <input type="checkbox"/> Silver <input type="checkbox"/> Black <input type="checkbox"/>	1 / 8
Pro-0440-W / Pro-0400-S / Pro-0400-B	4M track actual one meter.(400cm)	Aluminum Extrusion	White <input type="checkbox"/> Silver <input type="checkbox"/> Black <input type="checkbox"/>	1 / 6

Live-End Connector

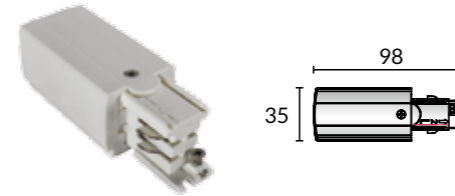

Model No.	Package	Colour
Pro-0431 L-W	1 / 150	White <input type="checkbox"/>
Pro-0431 L-S	1 / 150	Silver <input type="checkbox"/>
Pro-0431 L-B	1 / 150	Black <input type="checkbox"/>

Live-End Connector

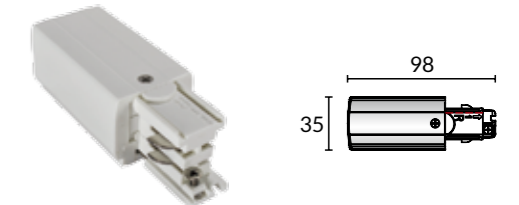

Model No.	Package	Colour
Pro-0431 R-W	1 / 150	White <input type="checkbox"/>
Pro-0431 R-S	1 / 150	Silver <input type="checkbox"/>
Pro-0431 R-B	1 / 150	Black <input type="checkbox"/>

Mini Joiner



Model No.	Package	Colour
Pro-0433-W	1 / 400	White <input type="checkbox"/>
Pro-0433-S	1 / 400	Silver <input type="checkbox"/>
Pro-0433-B	1 / 400	Black <input type="checkbox"/>

Mini Joiner(insulation)

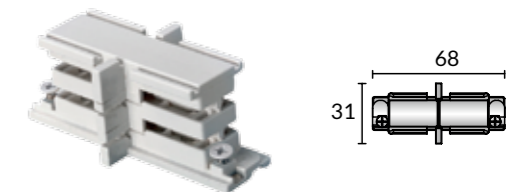

Model No.	Package	Colour
Pro-0433A-W	1 / 150	White <input type="checkbox"/>
Pro-0433A-S	1 / 150	Silver <input type="checkbox"/>
Pro-0433A-B	1 / 150	Black <input type="checkbox"/>

End Cap



Model No.	Package	Colour
Pro-0432-W	1 / 500	White <input type="checkbox"/>
Pro-0432-S	1 / 500	Silver <input type="checkbox"/>
Pro-0432-B	1 / 500	Black <input type="checkbox"/>

Mini Joiner(insulation)

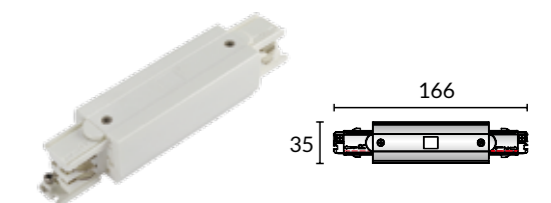

Model No.	Package	Colour
Pro-0434-W	1 / 150	White <input type="checkbox"/>
Pro-0434-S	1 / 150	Silver <input type="checkbox"/>
Pro-0434-B	1 / 150	Black <input type="checkbox"/>

Twisted "L" Connector

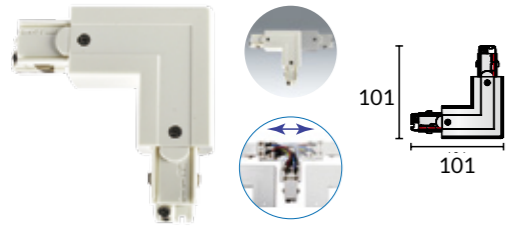

Model No.	Package	Colour
Pro-0438-W	1 / 154	White □
Pro-0438-S	1 / 154	Silver ■
Pro-0438-B	1 / 154	Black ■

"+" Connector



Model No.	Package	Colour
Pro-0437-W	1 / 60	White □
Pro-0437-S	1 / 60	Silver ■
Pro-0437-B	1 / 60	Black ■

Ceiling mount, EZCLIK suspension kit with ROD

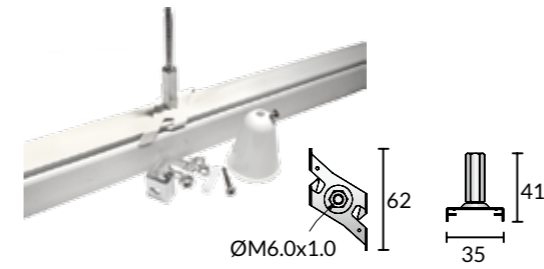

Model No.	Package	Colour
Pro-EZ0447-W	1 / 200	White □
Pro-EZ0447-S	1 / 200	Silver ■
Pro-EZ0447-B	1 / 200	Black ■

Ceiling mount, EZCLIK suspension kit with wire

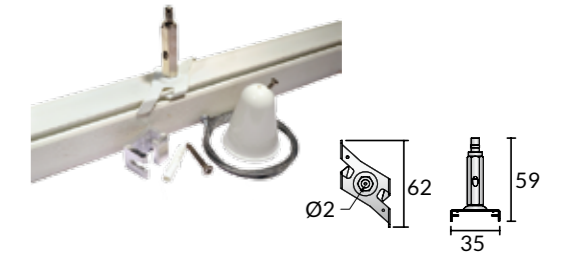

Model No.	Package	Colour
Pro-EZ0448-W	1 / 200	White □
Pro-EZ0448-S	1 / 200	Silver ■
Pro-EZ0448-B	1 / 200	Black ■

Flexible Connector

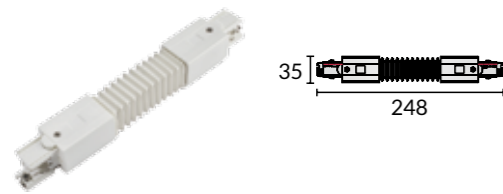

Model No.	Package	Colour
Pro-0439-W	1 / 119	White □
Pro-0439-S	1 / 119	Silver ■
Pro-0439-B	1 / 119	Black ■

Adjustable "L" Connector



Model No.	Package	Colour
Pro-0435-W	1 / 119	White □
Pro-0435-S	1 / 119	Silver ■
Pro-0435-B	1 / 119	Black ■

T-Bar, EZCLIK mounting kit

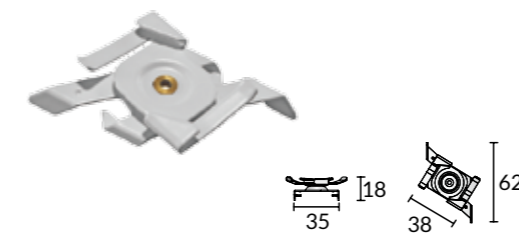

Model No.	Package	Colour
Pro-M146T-W	1 / 500	White □
Pro-M146T-S	1 / 500	Silver ■
Pro-M146T-B	1 / 500	Black ■

Suspension Mounting Kits Manual

1) Adjust the EZCLICK Mounting Kit's Direction, put it vertically into the T-Bar ceiling, and then rotate right and fix (as picture shows).

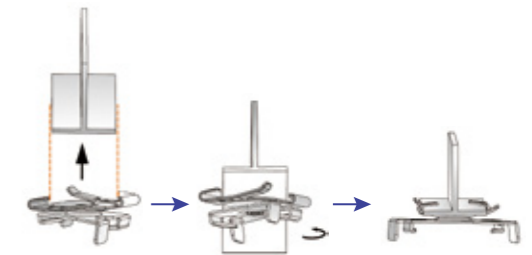

2) Adjust the EZCLICK Mounting Kit's Direction, put the track vertically into the EZCLICK Mounting Kit, rotate left and fix (like picture shows).

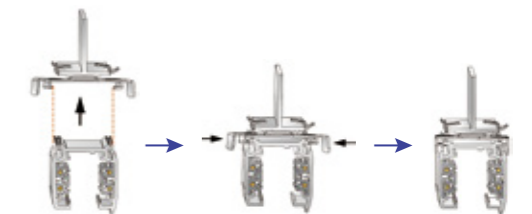

Twisted "T" Connector(Left)



Model No.	Package	Colour
Pro-M436L-W	1 / 84	White □
Pro-M436L-S	1 / 84	Silver ■
Pro-M436L-B	1 / 84	Black ■

Twisted "T" Connector(Right)



Model No.	Package	Colour
Pro-M436R-W	1 / 84	White □
Pro-M436R-S	1 / 84	Silver ■
Pro-M436R-B	1 / 84	Black ■

Ceiling Mount Reinforcement Plate with suspension wire

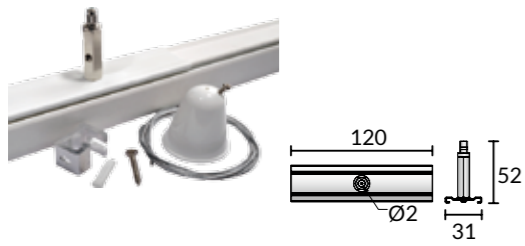

Model No.	Package	Colour
Pro-M147-W	1/200	White □
Pro-M147-S	1/200	Silver ■
Pro-M147-B	1/200	Black ■

Ceiling Mount Reinforcement Plate with suspension rod

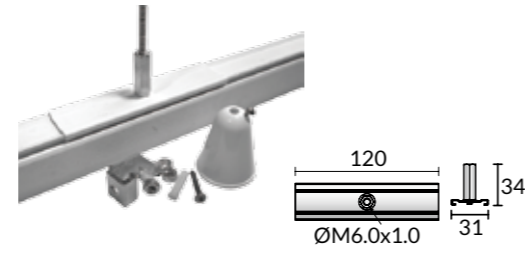

Model No.	Package	Colour
Pro-M148-W	1/200	White □
Pro-M148-S	1/200	Silver ■
Pro-M148-B	1/200	Black ■

T-Bar, EZCLICK with Reinforcement Plate

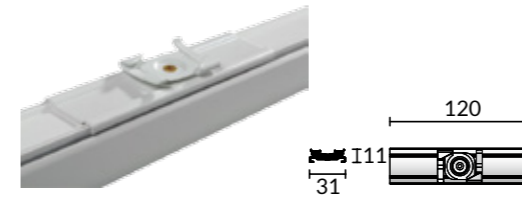

Model No.	Package	Colour
Pro-M149-W	1/200	White □
Pro-M149-S	1/200	Silver ■
Pro-M149-B	1/200	Black ■

Suspension Hook



Model No.	Package	Colour
Pro-M142-W	1/500	White □
Pro-M142-S	1/500	Silver ■
Pro-M142-B	1/500	Black ■

Suspension Mounting Kits Manual

1) Put the Track into the EZCLICK Mounting Kits Parallely (As picture shows).

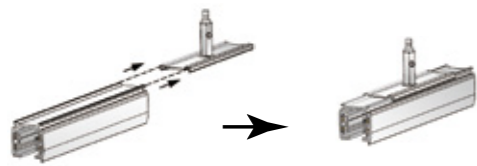

2) Release the start valve, press and get the wirerope through the EZCLICK Mounting Kit, rotate tight the start valve and lock the wirerope (like picture shows).

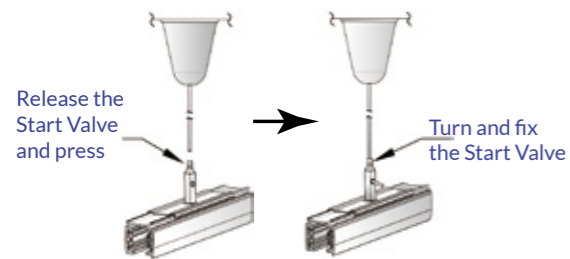

Suspension Mounting Kits Manual

1) Put the Track into the EZCLICK Kit Parallely (As picture shows).

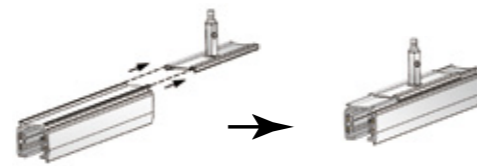

2) Rotate right the EZCLICK Kit and fix it on the rod.

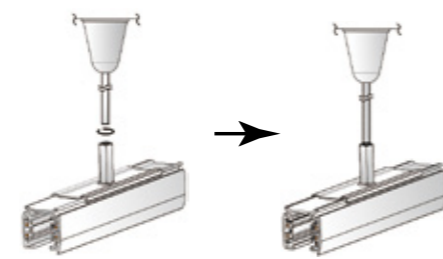

Suspension Mounting Kits Manual

1) Put the Track into the EZCLICK Mounting Kits parallely (As picture shows).

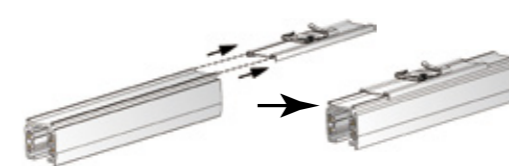

2) Adjust the EZCLICK Mounting Kit's direction, put the track vertically into the EZCLICK Mounting Kit, rotate right and fix (like picture shows).

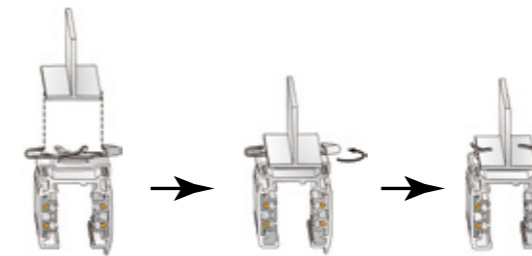

Mechanical Adaptor



Model No.	Package	Colour
Pro-0449-W	1/100	White □
Pro-0449-S	1/100	Silver ■
Pro-0449-B	1/100	Black ■

Suspension kit



Model No.	Package	Colour
Pro-04SK-W	1/100	White □
Pro-04SK-S	1/100	Silver ■
Pro-04SK-B	1/100	Black ■

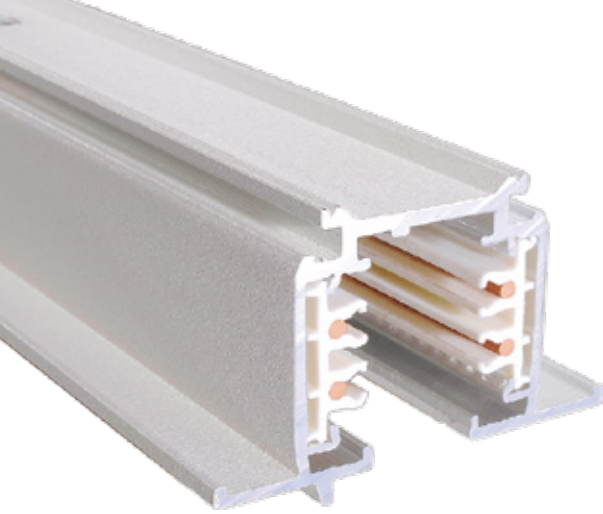

3 Circuits Recessed Track System

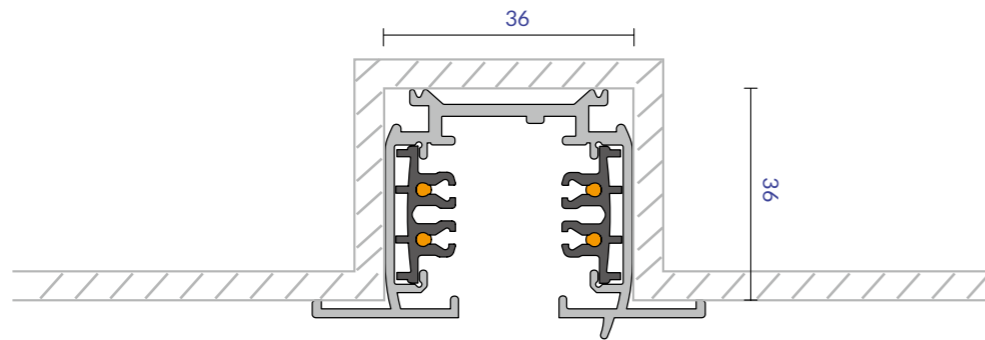
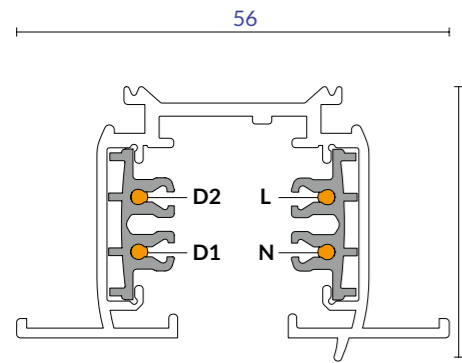

Model No.	Track length	Shell Material	Colour	Package
Pro-R410-W / Pro-R410-S / Pro-R410-B	1M track actual one meter.(100cm)	Aluminum Extrusion	White <input type="checkbox"/> Silver <input type="checkbox"/> Black <input type="checkbox"/>	1 / 9
Pro-R415-W / Pro-R415-S / Pro-R415-B	1.5M track actual one meter.(150cm)	Aluminum Extrusion	White <input type="checkbox"/> Silver <input type="checkbox"/> Black <input type="checkbox"/>	1 / 9
Pro-R420-W / Pro-R420-S / Pro-R420-B	2M track actual one meter.(200cm)	Aluminum Extrusion	White <input type="checkbox"/> Silver <input type="checkbox"/> Black <input type="checkbox"/>	1 / 9
Pro-R430-W / Pro-R430-S / Pro-R430-B	3M track actual one meter.(300cm)	Aluminum Extrusion	White <input type="checkbox"/> Silver <input type="checkbox"/> Black <input type="checkbox"/>	1 / 6
Pro-R4400-W / Pro-R4400-S / Pro-R4400-B	4M track actual one meter.(400cm)	Aluminum Extrusion	White <input type="checkbox"/> Silver <input type="checkbox"/> Black <input type="checkbox"/>	1 / 6

Live-end Connector Cover

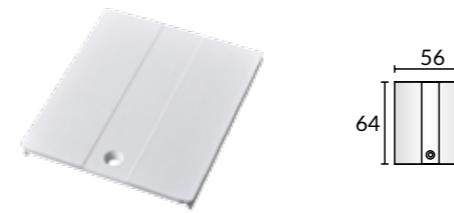

Model No.	Package	Colour
Pro-R431-W	1 / 500	White <input type="checkbox"/>
Pro-R431-S	1 / 500	Silver <input type="checkbox"/>
Pro-R431-B	1 / 500	Black <input type="checkbox"/>

Live-End Connector

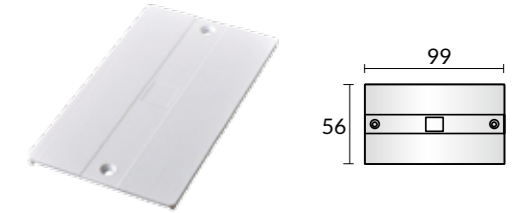

Model No.	Package	Colour
Pro-R434-W	1 / 400	White <input type="checkbox"/>
Pro-R434-S	1 / 400	Silver <input type="checkbox"/>
Pro-R434-B	1 / 400	Black <input type="checkbox"/>

Mini Joiner



Model No.	Package	Colour
Pro-R435-W	1 / 400	White <input type="checkbox"/>
Pro-R435-S	1 / 400	Silver <input type="checkbox"/>
Pro-R435-B	1 / 400	Black <input type="checkbox"/>

Mini Joiner(insulation)



Model No.	Package	Colour
Pro-R436-W	1 / 400	White <input type="checkbox"/>
Pro-R436-S	1 / 400	Silver <input type="checkbox"/>
Pro-R436-B	1 / 400	Black <input type="checkbox"/>

End Cap



Model No.	Package	Colour
Pro-R437-W	1 / 400	White <input type="checkbox"/>
Pro-R437-S	1 / 400	Silver <input type="checkbox"/>
Pro-R437-B	1 / 400	Black <input type="checkbox"/>

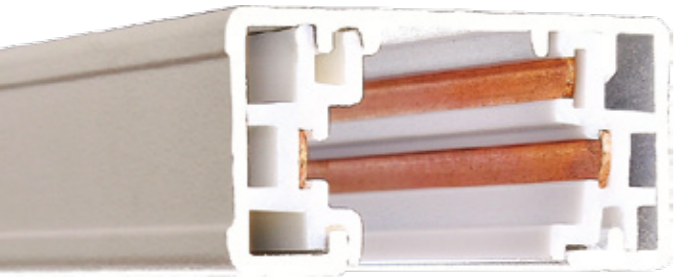

Single Circuit Track System 3 Wires

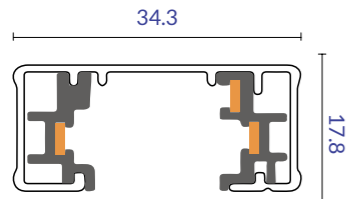

Model No.	Track length	Shell Material	Colour	Package
Pro-0310A	1M track with double end cap.(100cm)	Aluminum Extrusion	White <input type="checkbox"/> Silver <input type="checkbox"/> Black <input type="checkbox"/>	1/12
Pro-0320A	2M track with double end cap.(200cm)	Aluminum Extrusion	White <input type="checkbox"/> Silver <input type="checkbox"/> Black <input type="checkbox"/>	1/12
Pro-0330A	3M track with double end cap.(300cm)	Aluminum Extrusion	White <input type="checkbox"/> Silver <input type="checkbox"/> Black <input type="checkbox"/>	1/9
Pro-03400A	4M track with double end cap.(400cm)	Aluminum Extrusion	White <input type="checkbox"/> Silver <input type="checkbox"/> Black <input type="checkbox"/>	1/9
Pro-0302A	2'track with double end cap actual length24"	Aluminum Extrusion	White <input type="checkbox"/> Silver <input type="checkbox"/> Black <input type="checkbox"/>	1/12
Pro-0304A	4'track with double end cap actual length48"	Aluminum Extrusion	White <input type="checkbox"/> Silver <input type="checkbox"/> Black <input type="checkbox"/>	1/12
Pro-0306A	6'track with double end cap actual length72"	Aluminum Extrusion	White <input type="checkbox"/> Silver <input type="checkbox"/> Black <input type="checkbox"/>	1/12
Pro-0308A	8'track with double end cap actual length96"	Aluminum Extrusion	White <input type="checkbox"/> Silver <input type="checkbox"/> Black <input type="checkbox"/>	1/12
Pro-0310B	1M track with live end & end cap.(100cm)	Aluminum Extrusion	White <input type="checkbox"/> Silver <input type="checkbox"/> Black <input type="checkbox"/>	1/12
Pro-0320B	2M track with live end & end cap.(200cm)	Aluminum Extrusion	White <input type="checkbox"/> Silver <input type="checkbox"/> Black <input type="checkbox"/>	1/12
Pro-0330B	3M track with live end & end cap.(300cm)	Aluminum Extrusion	White <input type="checkbox"/> Silver <input type="checkbox"/> Black <input type="checkbox"/>	1/9
Pro-03400B	4M track with live end & end cap.(400cm)	Aluminum Extrusion	White <input type="checkbox"/> Silver <input type="checkbox"/> Black <input type="checkbox"/>	1/9
Pro-0302B	2'track with live end and end cap actual length24"	Aluminum Extrusion	White <input type="checkbox"/> Silver <input type="checkbox"/> Black <input type="checkbox"/>	1/12
Pro-0304B	4'track with live end and end cap actual length48"	Aluminum Extrusion	White <input type="checkbox"/> Silver <input type="checkbox"/> Black <input type="checkbox"/>	1/12
Pro-0306B	6'track with live end and end cap actual length72"	Aluminum Extrusion	White <input type="checkbox"/> Silver <input type="checkbox"/> Black <input type="checkbox"/>	1/12
Pro-0308B	8'track with live end and end cap actual length96"	Aluminum Extrusion	White <input type="checkbox"/> Silver <input type="checkbox"/> Black <input type="checkbox"/>	1/12
Pro-0310C	1M track with live end & end cap.(100cm)	Aluminum Extrusion	White <input type="checkbox"/> Silver <input type="checkbox"/> Black <input type="checkbox"/>	1/12
Pro-0320C	2M track with live end & end cap.(200cm)	Aluminum Extrusion	White <input type="checkbox"/> Silver <input type="checkbox"/> Black <input type="checkbox"/>	1/12
Pro-0330C	3M track with live end & end cap.(300cm)	Aluminum Extrusion	White <input type="checkbox"/> Silver <input type="checkbox"/> Black <input type="checkbox"/>	1/9
Pro-03400C	4M track with live end & end cap.(400cm)	Aluminum Extrusion	White <input type="checkbox"/> Silver <input type="checkbox"/> Black <input type="checkbox"/>	1/9
Pro-0302C	2'track with live end and end cap actual length24"	Aluminum Extrusion	White <input type="checkbox"/> Silver <input type="checkbox"/> Black <input type="checkbox"/>	1/12
Pro-0304C	4'track with live end and end cap actual length48"	Aluminum Extrusion	White <input type="checkbox"/> Silver <input type="checkbox"/> Black <input type="checkbox"/>	1/12
Pro-0306C	6'track with live end and end cap actual length72"	Aluminum Extrusion	White <input type="checkbox"/> Silver <input type="checkbox"/> Black <input type="checkbox"/>	1/12
Pro-0308C	8'track with live end and end cap actual length96"	Aluminum Extrusion	White <input type="checkbox"/> Silver <input type="checkbox"/> Black <input type="checkbox"/>	1/12

Single Circuit Recessed 3 Wires

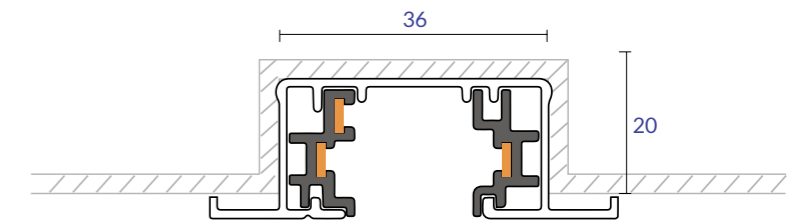
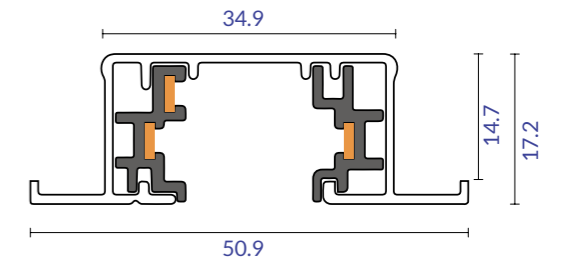
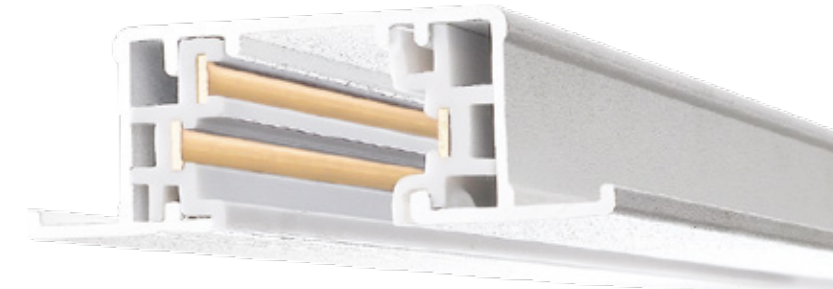

Model No.	Track length	Shell Material	Colour	Package
Pro-R310A	1M track with double end cap.(100cm)	Aluminum Extrusion	White <input type="checkbox"/> Silver <input type="checkbox"/> Black <input type="checkbox"/>	1/12
Pro-R320A	2M track with double end cap.(200cm)	Aluminum Extrusion	White <input type="checkbox"/> Silver <input type="checkbox"/> Black <input type="checkbox"/>	1/12
Pro-R330A	3M track with double end cap.(300cm)	Aluminum Extrusion	White <input type="checkbox"/> Silver <input type="checkbox"/> Black <input type="checkbox"/>	1/12
Pro-R3400A	4M track with double end cap.(400cm)	Aluminum Extrusion	White <input type="checkbox"/> Silver <input type="checkbox"/> Black <input type="checkbox"/>	1/9
Pro-R302A	2'track with double end cap actual length24"	Aluminum Extrusion	White <input type="checkbox"/> Silver <input type="checkbox"/> Black <input type="checkbox"/>	1/12
Pro-R304A	4'track with double end cap actual length48"	Aluminum Extrusion	White <input type="checkbox"/> Silver <input type="checkbox"/> Black <input type="checkbox"/>	1/12
Pro-R306A	6'track with double end cap actual length72"	Aluminum Extrusion	White <input type="checkbox"/> Silver <input type="checkbox"/> Black <input type="checkbox"/>	1/12
Pro-R308A	8'track with double end cap actual length96"	Aluminum Extrusion	White <input type="checkbox"/> Silver <input type="checkbox"/> Black <input type="checkbox"/>	1/12
Pro-R310B	1M track with live end & end cap.(100cm)	Aluminum Extrusion	White <input type="checkbox"/> Silver <input type="checkbox"/> Black <input type="checkbox"/>	1/12
Pro-R320B	2M track with live end & end cap.(200cm)	Aluminum Extrusion	White <input type="checkbox"/> Silver <input type="checkbox"/> Black <input type="checkbox"/>	1/12
Pro-R330B	3M track with live end & end cap.(300cm)	Aluminum Extrusion	White <input type="checkbox"/> Silver <input type="checkbox"/> Black <input type="checkbox"/>	1/12
Pro-R3400B	4M track with live end & end cap.(400cm)	Aluminum Extrusion	White <input type="checkbox"/> Silver <input type="checkbox"/> Black <input type="checkbox"/>	1/9
Pro-R302B	2'track with live end and end cap actual length24"	Aluminum Extrusion	White <input type="checkbox"/> Silver <input type="checkbox"/> Black <input type="checkbox"/>	1/12
Pro-R304B	4'track with live end and end cap actual length48"	Aluminum Extrusion	White <input type="checkbox"/> Silver <input type="checkbox"/> Black <input type="checkbox"/>	1/12
Pro-R306B	6'track with live end and end cap actual length72"	Aluminum Extrusion	White <input type="checkbox"/> Silver <input type="checkbox"/> Black <input type="checkbox"/>	1/12
Pro-R308B	8'track with live end and end cap actual length96"	Aluminum Extrusion	White <input type="checkbox"/> Silver <input type="checkbox"/> Black <input type="checkbox"/>	1/12

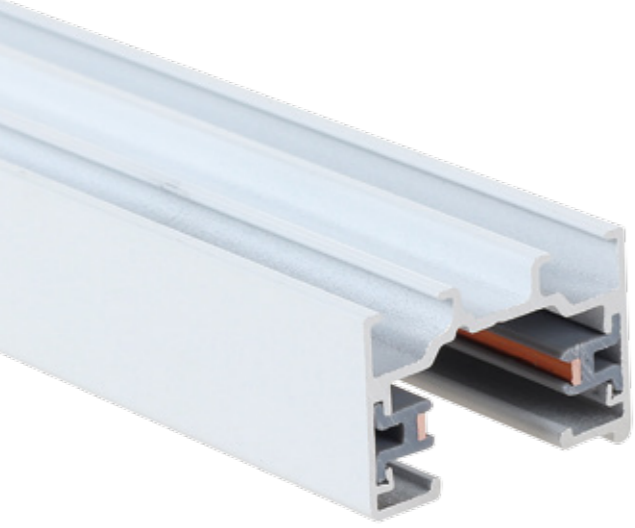

Single Circuit Track System 2 Wires

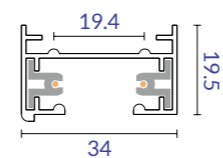

Model No.	Track length	Shell Material	Colour
Pro-L210-W	1M / 1.5M / 2M / 3M track actual one meter. (100cm / 150cm / 200cm / 300cm)	Aluminum Extrusion	White <input type="checkbox"/> Silver <input type="checkbox"/> Black <input type="checkbox"/>



Model No.	Track length	Shell Material	Colour
Pro-RL210-W	1M / 1.5M / 2M / 3M track actual one meter. (100cm / 150cm / 200cm / 300cm)	Aluminum Extrusion	White <input type="checkbox"/> Silver <input type="checkbox"/> Black <input type="checkbox"/>

Single Circuit Recessed 6Wires

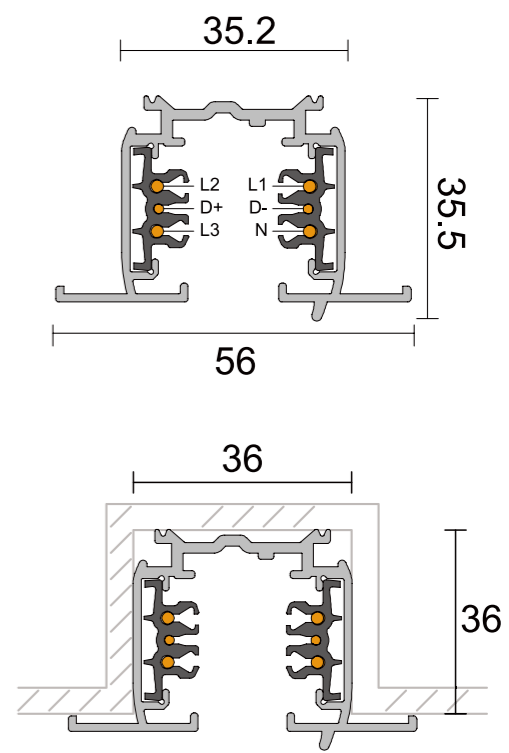

Model No.	Track length	Shell Material	Colour	Package
Pro-R610	1000(mm)	Aluminum Extrusion	White <input type="checkbox"/> Silver <input type="checkbox"/> Black <input type="checkbox"/>	1 / 9
Pro-R620	2000(mm)	Aluminum Extrusion	White <input type="checkbox"/> Silver <input type="checkbox"/> Black <input type="checkbox"/>	1 / 9
Pro-R630	3000(mm)	Aluminum Extrusion	White <input type="checkbox"/> Silver <input type="checkbox"/> Black <input type="checkbox"/>	1 / 6
Pro-R6400	4000(mm)	Aluminum Extrusion	White <input type="checkbox"/> Silver <input type="checkbox"/> Black <input type="checkbox"/>	1 / 4

LED Track light



LED Panel Light

/Series/

LED panel light is one of the most popular luminaire for commercial lighting, with continuous modification of its design, light efficiency, CRI, UGR and smart function, ELWA Lighting is always capable of providing customers with helpful solution and best price, that's the main reason ELWA Lighting is preferred supplier of LED panel lamp in the market. ELWA LED panel family supply different solution for project and distribution, such as regular LED panel with high Lumen and low UGR, CCT changing LED panel, waterproof led panel, frameless led panel, Up/down emitting led panel, big size round led panel with recessed / surface mounted / pendant installation, TUV-CE approved ELWA driver and Lifud, Tridonic, Philips driver ensure our reputation of quality always.

PL-CK5 Backlit panel light

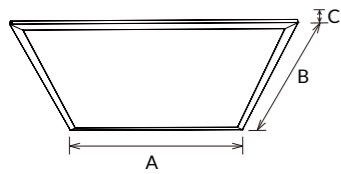

PL-CK5 backlit panel is ultra slim design with external driver, adopts high quality SMD led with optical lens to provide a uniform light effect, high efficiency, no LGP design makes this panel more cost effective compared with normal edge-lit panel. UGR19, CCT switchable are available.

- 90°
- 120°
- IP50
- IP54
- UGR<19
- DIM
- DALI
- 0-10V
- Flicker Free
- SLIDE SWITCH 3 in 1
- WIFI
- Smart Lighting
- CASAMBI
- AC 220-240V
- PF≥0.9
- CRI≥80
- SAA
- RoHS
- CE
- CB

Code	Watt	Size(AxBxCmm)	Cut-out(±5mm)	Lumen(±5%)	N.W/pc(kgs)	Q'ty/CTN
PL6060-36W-CK5	36W	595x595x25	580x580	100lm/W (90lm/W UGR<19)	1.82	5PCS/6PCS
PL6262-36W-CK5	36W	620x620x25	605x605	100lm/W (90lm/W UGR<19)	1.91	5PCS/6PCS
PL30120-36W-CK5	36W	1195x295x25	1180x280	100lm/W (90lm/W UGR<19)	1.86	5PCS/6PCS
PL6060-36W-CK5	36W	595x595x25	580x580	120lm/W (110lm/W UGR<19)	1.82	5PCS/6PCS
PL6262-36W-CK5	36W	620x620x25	605x605	120lm/W (110lm/W UGR<19)	1.91	5PCS/6PCS
PL30120-36W-CK5	36W	1195x295x25	1180x280	120lm/W (110lm/W UGR<19)	1.86	5PCS/6PCS
PL6060-30W-CK5	30W	595x595x25	580x580	140lm/W (130lm/W UGR<19)	1.82	5PCS/6PCS
PL6262-30W-CK5	30W	620x620x25	605x605	140lm/W (130lm/W UGR<19)	1.91	5PCS/6PCS
PL30120-30W-CK5	30W	1195x295x25	1180x280	140lm/W (130lm/W UGR<19)	1.86	5PCS/6PCS
PL6060-20W-CK5	20W	595x595x25	580x580	180lm/W (160lm/W UGR<19)	1.82	5PCS/6PCS
PL6262-20W-CK5	20W	620x620x25	605x605	180lm/W (160lm/W UGR<19)	1.91	5PCS/6PCS
PL30120-20W-CK5	20W	1195x295x25	1180x280	180lm/W (160lm/W UGR<19)	1.86	5PCS/6PCS
PL6060-22W-CK5 NEW	22W	595x595x25	580x580	4260lm (200lm/W)	8.40	6PCS
PL6262-22W-CK5 NEW	22W	620x620x25	605x605	4260lm (200lm/W)	9.70	6PCS
PL30120-22W-CK5 NEW	22W	1195x295x25	1180x280	4260lm (200lm/W)	9.60	6PCS
PL60120-40W-CK5 NEW	40W	1195x595x25	1180x580	7800lm (200lm/W)	13.1	4PCS

CCT ——— 3000K 4000K 5000K 5700K

Finish ——— White

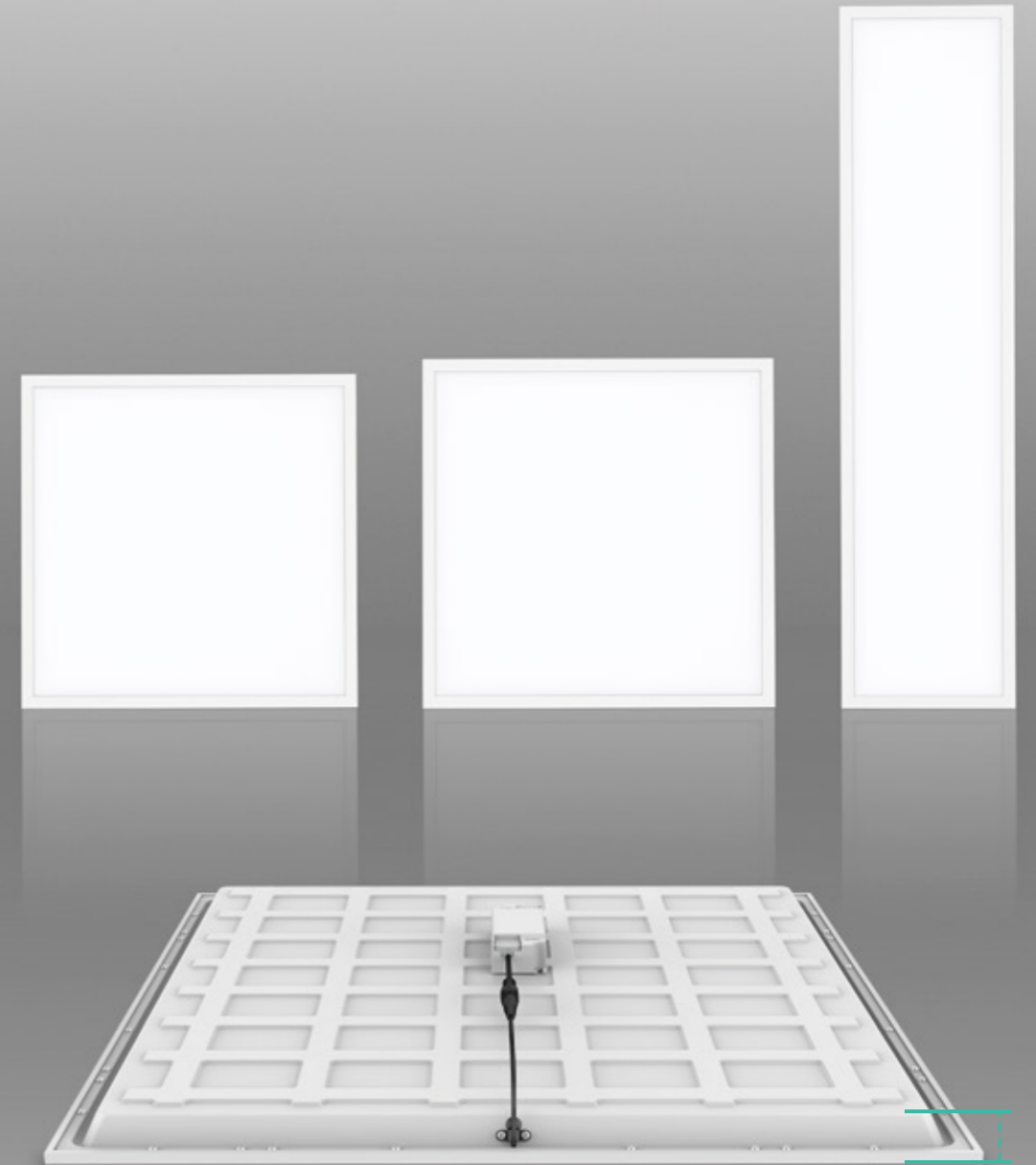

25mm

PL-CK5 SUPER SLIM BACKLIT PANEL

LED Panel light



PL-CK8

Backlit panel light

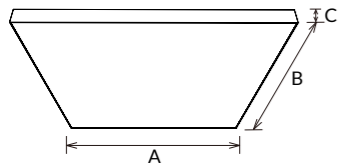

panel is backlit panel with frameless design. Adopt high lumen 2835 SMD light source, CRI>80 and CRI>90 for option, CCT switch is available. Recessed, suspended and surface mounted installation ways for choice.

- ▶ IP40
- ▶ DIM DALI 0-10V Flicker Free CCT SWITCH 2 in 1
- ▶ AC 200-240V PF≥0.9 CRI≥80 CRI≥90
- ▶ SAA RoHS CE CB

Code	Watt	Size(AxBxCmm)	Cut-out(mm)	Lumen(±5%)	N.W/pc(kgs)	Q'ty/CTN
PL6060-CK8-36W	36W	595x595x50	580x580	4770lm	2.70	5PCS
PL30120-CK8-36W	36W	1195x295x50	1180x280	4450lm	3.20	5PCS

CCT — 3000K 4000K 5000K 5700K

Finish — White

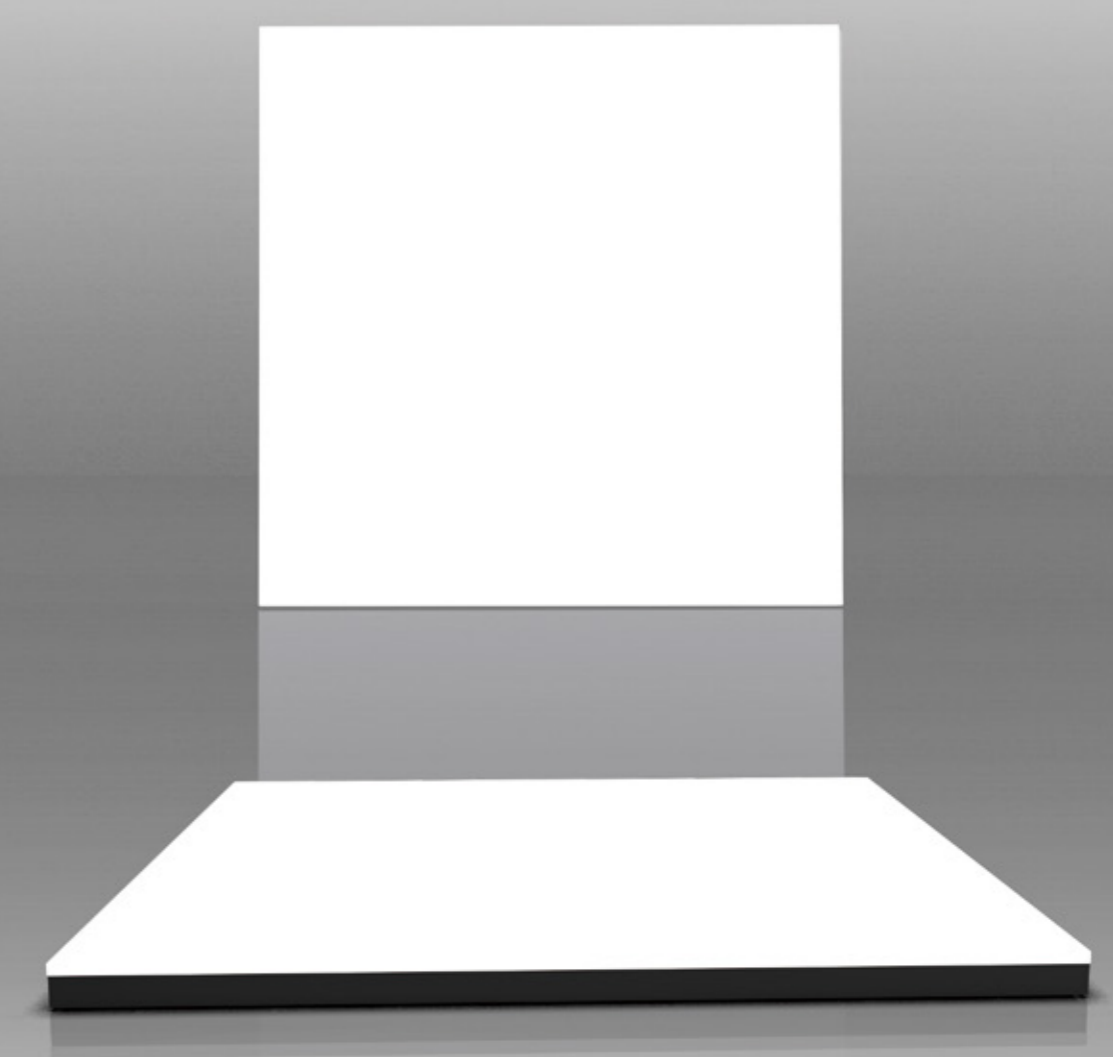

PL-CK8

FRAMELESS PANEL

LED Panel light

PL-CK2 Backlit panel light

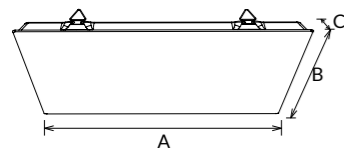

PL-CK2 panel is a patented frameless design with larger lighting area, direct lighting way makes full use of all light. Adopt high lumen 2835 SMD light source, the optical lens provides a uniform light output. The lamps are directly provided with pendants, which is convenient for installation. 2CCT/ 3CCT adjustable by slide switch is available.

- ▶ 120°
- ▶ IP40
- ▶ DIM
- ▶ DALI
- ▶ 0-10V
- ▶ Flicker Free
- ▶ SLIDE SWITCH 3 in 1
- ▶ AC 200-240V
- ▶ PF ≥ 0.9
- ▶ CRI ≥ 80
- ▶ TP(a)
- ▶ TP(b)
- ▶ SAA
- ▶ CE
- ▶ CB

Code	Watt	Size(AxBxCmm)	Cut-out(±5mm)	Lumen(±5%)	N.W/pc(kgs)	Q'ty/CTN
PL6060-36W-CK2	36W	595x595x28	580x580	120LM/W	1.50	5PCS/6PCS
PL6262-36W-CK2	36W	620x620x28	605x605	120LM/W	1.82	5PCS/6PCS
PL30120-36W-CK2	36W	1195x295x28	1180x280	120LM/W	1.76	5PCS/6PCS
PL6060-25W-CK2	25W	595x595x28	580x580	130LM/W	1.50	5PCS/6PCS
PL6262-25W-CK2	25W	620x620x28	605x605	130LM/W	1.82	5PCS/6PCS
PL30120-25W-CK2	25W	1195x295x28	1180x280	130LM/W	1.76	5PCS/6PCS
PL6060-28W-CK2	28W	595x595x28	580x580	130LM/W	1.50	5PCS/6PCS
PL6262-28W-CK2	28W	620x620x28	605x605	130LM/W	1.82	5PCS/6PCS
PL30120-28W-CK2	28W	1195x295x28	1180x280	130LM/W	1.76	5PCS/6PCS

CCT — 3000K 4000K 5000K 5700K

Finish — White

PL-CK003 Backlit Panel light

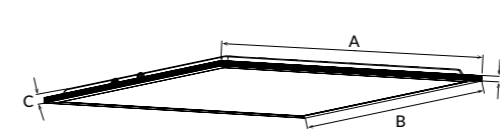

PL-CK003 is an IP65 rating panel light with backlit lighting structure, with external IP65 driver, the whole lamp satisfy IP65. It adopts PMMA optical lens and high lumen SMD, give uniform light output and avoid yellow risky. The panel equipped with a waterproof and breathable valve to balance the pressure inside and outside.

- ▶ 120°
- ▶ IP65
- ▶ Flicker Free
- ▶ AC 220-240V
- ▶ PF ≥ 0.9
- ▶ CRI ≥ 80
- ▶ SAA
- ▶ RoHS
- ▶ CE
- ▶ CB

Code	Watt	Size(AxBxCmm)	Cut-out(mm)	Lumen(±5%)	N.W/pc(kgs)	Q'ty/CTN
PL-CK003-6060-36W	36W	595x595x27	Ø570x570	3680lm	1.82	5PCS
PL-CK003-30120-36W	36W	295x1195x27	Ø270x1170	3600lm	2.02	5PCS

CCT — 3000K 4000K 5000K 5700K

Finish — White

PL-DS Panel light



PL-DS panel adopts upper and lower frame structure design to reach an IP65 waterproof effect, it has a strong structure with 10mm thickness. Upper and lower 6063 Aluminium frames provide a great thermal management to ensure a long lifespan. Besides, it has high lumen SMD light source and PMMA LGP which offer a uniform light output and avoid yellow risky. External IP65 flicker free driver with waterproof DC connector UGR<19 available. Multiple installation ways: recessed, suspended and surface mounted.



Code	Watt	Size(AxBxCmm)	Cut-out(±5mm)	Lumen(±5%)	N.W/pc(kgs)	Q'ty/CTN
PL3030-15W-DS	15W	295x295x10	280x280	1275lm	1.05	10PCS
PL3060-20W-DS	20W	595x295x10	580x280	1800lm	1.79	5PCS
PL6060-36W-DS	36W	595x595x10	580x580	3600lm	3.16	4PCS
PL6262-36W-DS	36W	620x620x10	605x605	3600lm	3.43	4PCS
PL30120-36W-DS	36W	1195x295x10	1180x280	3600lm	3.31	4PCS
PL60120-60W-DS	60W	1195x595x10	1180x580	6300lm	6.37	2PCS
PL3030-10W-DS (UGR<19)	10W	295x295x10	280x280	950lm	1.05	10PCS
PL3060-15W-DS (UGR<19)	15W	595x295x10	580x280	1575lm	1.79	5PCS
PL6060-36W-DS (UGR<19)	36W	595x595x10	580x580	3960lm	3.16	4PCS
PL6262-36W-DS (UGR<19)	36W	620x620x10	605x605	3960lm	3.43	4PCS
PL30120-36W-DS (UGR<19)	36W	1195x295x10	1180x280	3960lm	3.31	4PCS

CCT 3000K 4000K 5000K 5700K

Finish White

PL-CB Panel light

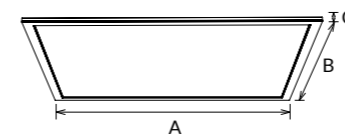

PL-CB panel light is a 9mm thickness panel with external driver; PMMA LGP produce uniform light and high lumen output; Adopts high lumen SMD with CRI>80, 100lm/W, 130lm/W, SDCM<3 solution can be provided, Triac dim, 0-10V dimmable, DALI dimmable, Emergency all available. It can fit seamlessly into any work place, available in various installation ways: recessed, suspended and surface mounted.

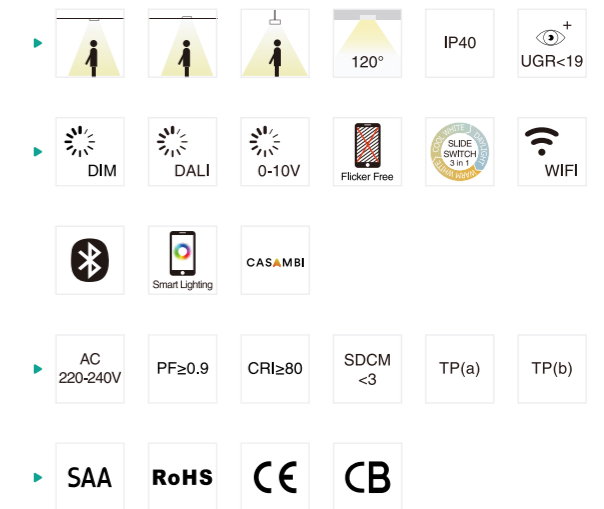

Code	Watt	Size(AxBxCmm)	Cut-out(±5mm)	Lumen(±5%)	N.W/pc(kgs)	Q'ty/CTN
PL3030-18W-CB	18W	295x295x9	280x280	100LM/W	0.85	5PCS
PL3060-20W-CB	20W	595x295x9	580x280	100LM/W	1.35	5PCS
PL30120-33W-CB	33W	1195x295x9	1180x280	100LM/W	2.40	5PCS
PL30120-42W-CB	42W	1195x295x9	1180x280	100LM/W	2.40	5PCS
PL6060-33W-CB	33W	595x595x9	580x580	100LM/W	2.35	5PCS
PL6060-42W-CB	42W	595x595x9	580x580	100LM/W	2.35	5PCS
PL60120-60W-CB	60W	1195x595x9	1180x580	100LM/W	5.30	2PCS
PL6262-33W-CB	33W	620x620x9	605x605	100LM/W	2.55	5PCS
PL6262-42W-CB	42W	620x620x9	605x605	100LM/W	2.55	5PCS
PL6060-25W-CB	25W	595x595x9	580x580	130LM/W	2.35	5PCS
PL6262-25W-CB	25W	620x620x9	605x605	130LM/W	2.55	5PCS
PL30120-25W-CB	25W	1195x295x9	1180x280	130LM/W	2.40	5PCS
PL60120-45W-CB	45W	1195x595x9	1180x580	130LM/W	5.30	2PCS

CCT 3000K 4000K 5000K 5700K

Finish White

PL-G5B Panel light



PL-G5B is 10mm thickness edgelit panel, which adopts high lumen SMD LED acheive 120lm/W, with external flickering free driver, triac dim, 0-10V dim and DALI dim available. It available with various installation ways: embedded into ceiling, suspended with hanging wires, surface mounted in a concrete ceiling by using surface mounting frame.

- 120°
- IP20
- DIM
- DALI
- 0-10V
- Flicker Free
- TUNABLE WHITE
- AC 200-240V
- PF ≥ 0.9
- CRI ≥ 80
- SAA
- RoHS
- CE

Code	Watt	Size(AxBxCmm)	Cut-out(±5mm)	Lumen(±5%)	N.W/pc(kgs)	Q'ty/CTN
PL3030-10W-G5B	10W	295x295x10	280x280	1210lm	0.76	12PCS
PL3060-20W-G5B	20W	595x295x10	580x280	2530lm	1.37	6PCS
PL6060-28W-G5B	28W	595x595x10	580x580	3696lm	2.60	5PCS
PL6060-33W-G5B	33W	595x595x10	580x580	4356lm	2.60	5PCS
PL6262-28W-G5B	28W	620x620x10	605x605	3696lm	2.80	2PCS
PL6262-33W-G5B	33W	620x620x10	605x605	4356lm	2.80	2PCS
PL30120-28W-G5B	28W	1195x295x10	1180x280	3696lm	2.67	5PCS
PL30120-33W-G5B	33W	1195x295x10	1180x280	4356lm	2.67	5PCS
PL60120-50W-G5B	50W	1195x595x10	1180x580	6600lm	5.23	2PCS

CCT 3000K 4000K 5000K 5700K

Finish White

PL-G6B Panel light

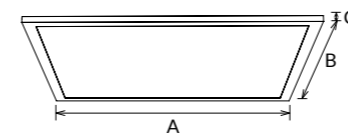

PL-G6B is UGR<19 10mm thickness edgelit panel, which adopts high lumen SMD LED acheive 120lm/W, with external flickering free driver, triac dim, 0-10V dim and DALI dim available. It available with various installation ways: embedded into ceiling, suspended with hanging wires, surface mounted in a concrete ceiling by using surface mounting frame.

- 80°
- IP20
- UGR<19
- DIM
- DALI
- 0-10V
- Flicker Free
- TUNABLE WHITE
- AC 200-240V
- PF ≥ 0.9
- CRI ≥ 80
- SAA
- RoHS
- CE

Code	Watt	Size(AxBxCmm)	Cut-out(±5mm)	Lumen(±5%)	N.W/pc(kgs)	Q'ty/CTN
PL3030-10W-G6B	10W	295x295x10	280x280	1210lm	0.76	12PCS
PL3060-20W-G6B	20W	595x295x10	580x280	2530lm	1.37	6PCS
PL6060-28W-G6B	28W	595x595x10	580x580	3696lm	2.60	5PCS
PL6060-33W-G6B	33W	595x595x10	580x580	4356lm	2.60	5PCS
PL6262-28W-G6B	28W	620x620x10	605x605	3696lm	2.80	5PCS
PL6262-33W-G6B	33W	620x620x10	605x605	4356lm	2.80	5PCS
PL30120-28W-G6B	28W	1195x295x10	1180x280	3696lm	2.67	5PCS
PL30120-33W-G6B	33W	1195x295x10	1180x280	4356lm	2.67	5PCS
PL60120-50W-G6B	50W	1195x595x10	1180x580	6600lm	5.23	2PCS

CCT 3000K 4000K 5000K 5700K

Finish White



PL-CC Panel light

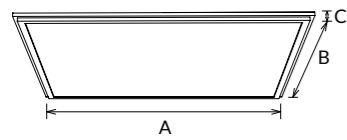

PL-CC panel is 14.3mm thickness panel with external driver, adopts high lumen LED chips with CRI>80, PMMA LGP produces uniform and comfortable light. Stronger frame makes better heat dissipation than common panels. The lighting area fits seamlessly with the ceiling. Recessed installation with clips make it suitable for more kinds of ceiling perfectly.

- ▶ 120° IP40
- ▶ DIM DALI 0-10V Flicker Free
- ▶ AC 220-240V PF≥0.9 CRI≥80
- ▶ SAA RoHS CE

Code	Watt	Size(AxBxCmm)	Cut-out(±5mm)	Lumen(±5%)	N.W/pc(kgs)	Q'ty/CTN
PL6060-33W-CC	33W	595x595x14.3	585x585	3530lm	2.50	5PCS
PL6060-42W-CC	42W	595x595x14.3	585x585	4370lm	2.50	5PCS
PL30120-33W-CC	33W	1195x295x14.3	285x1185	3400lm	2.65	5PCS
PL30120-42W-CC	42W	1195x295x14.3	285x1185	4210lm	2.65	5PCS

CCT — 3000K 4000K 5000K 5700K

Finish — White



PL-CD Panel light

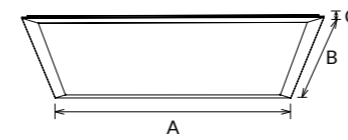

PL-CD panel light is 8.5mm thickness frame with fixed spring design panel light with external driver, adopts high lumen LED chips with CRI>80, special frame design provides excellent thermal management. Recessed installation with clips makes it suitable for more kinds of ceiling.

- ▶ 120° IP40
- ▶ DIM DALI 0-10V Flicker Free
- ▶ AC 220-240V PF≥0.9 CRI≥80
- ▶ SAA RoHS CE

Code	Watt	Size(AxBxCmm)	Cut-out(±5mm)	Lumen(±5%)	N.W/pc(kgs)	Q'ty/CTN
PL6060-33W-CD	33W	595x595x35.5	585x585	3460lm	2.35	5PCS
PL30120-33W-CD	33W	1195x295x35.5	285x1185	3400lm	2.40	5PCS

CCT — 3000K 4000K 5000K 5700K

Finish — White

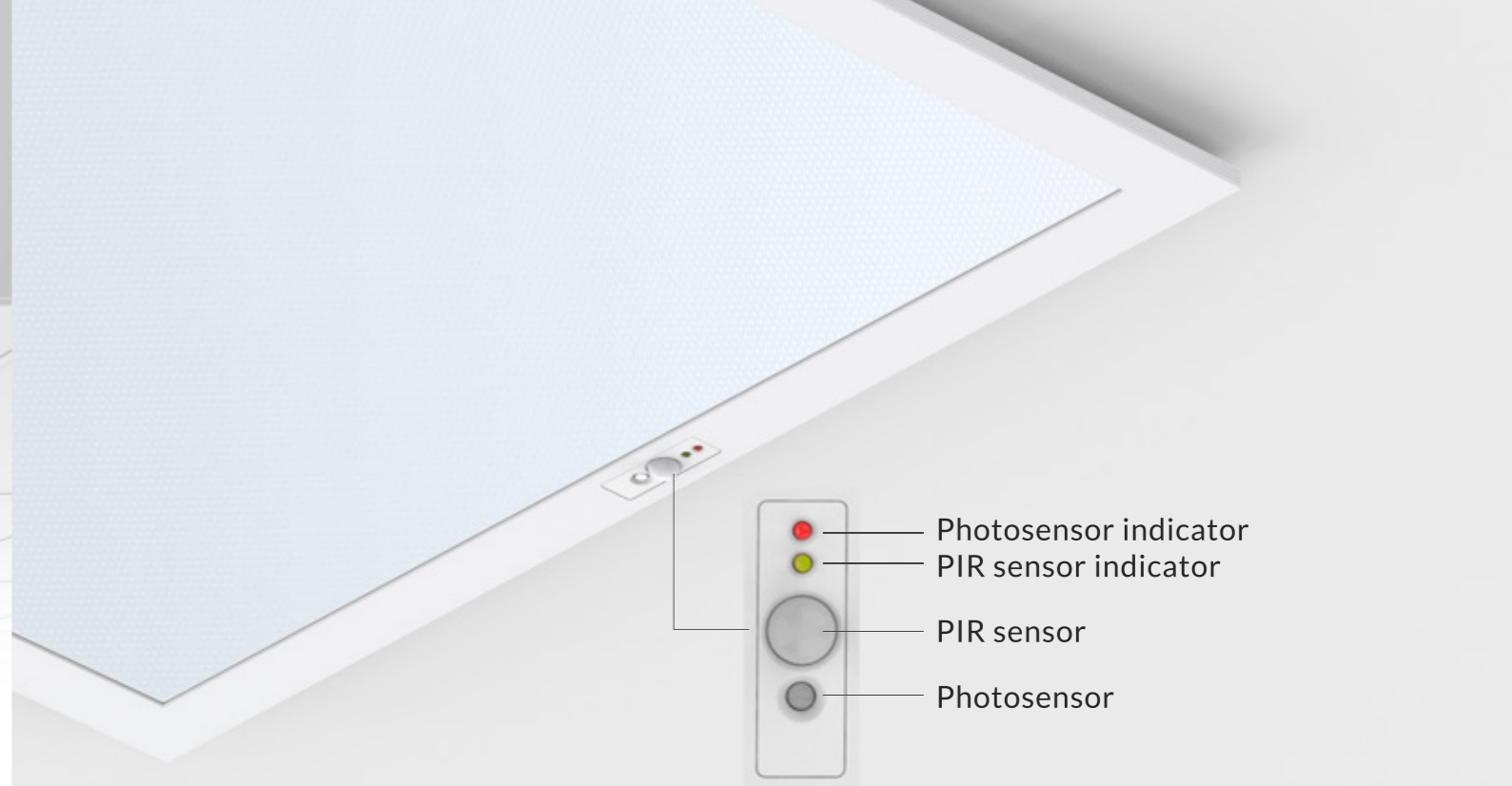

- Photosensor indicator
- PIR sensor indicator
- PIR sensor
- Photosensor

PL-DP Panel light

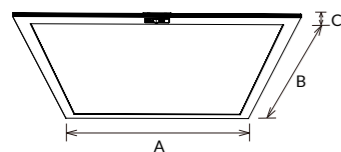

PL-DP is smart panel light, which is comprised of driver, smart control module and induction module. Connect Bluetooth between the mobile phone and the lamp, then the mobile phone APP can control the lamp. Users can adjust the brightness and color temperature of lamps according to their own needs. Automatic light supplement can also be realized by photo sensor. The PIR sensor is used to switch the lamp, and the indicator light is used to display the on/off state of the photosensitive sensor and PIR sensor of the Lamp.

- ▶
- ▶
- ▶

PHOTOSENSOR

daylight harvest, change brightness according to the ambient

PIR SENSOR

hold time & detection distance adjustable

SMARTPHONE APP CONTROL

- CCT Adjustable
- Dimming
- Photosensor
- Time setting
- Electricity consumption
- Record
- turn on/off sensors in App
- Self-test function
- Scene setting

STANDBY POWER < 0.5W

Code	Watt	Size(AxBxCmm)	Cut-out(±5mm)	Lumen(±5%)	N.W/pc(kgs)	Q'ty/CTN
PL6060-40W-DP	40W	595x595x8.5	580x580	4000lm	3.10	4PCS
PL6262-40W-DP	40W	620x620x8.5	605x605	4000lm	3.50	4PCS
PL30120-40W-DP	40W	1195x295x8.5	1180x280	4000lm	3.10	4PCS

CCT 2700K-6500K

Finish White

GL-P Panel light

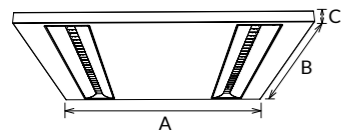

GL-P panel light is direct lighting with louver anti-glare design with external driver, adopting high lumen SMD led and special lens which provide high light efficiency and uniform light output, SPCC housing plus PC + ABS module form ideal combination of stylish design, it is a perfect replacement for traditional grill lamp.

- 80°
- IP40
- UGR<19
- DIM
- DALI
- 0-10V
- Flicker Free
- Bluetooth
- CASAMBI
- AC 220-240V
- PF≥0.9
- CRI≥80
- SAA
- RoHS
- CE

Code	Watt	Size(AxBxCmm)	Cut-out(±5mm)	Lumen(±5%)	N.W/pc(kgs)	Q'ty/CTN
GL6060-35W-P	35W	595x595x23.5	555x555	4450lm	3.50	4PCS
GL6262-35W-P	35W	620x620x23.5	580x580	4450lm	3.65	4PCS
GL30120-35W-P	35W	295x1195x23.5	255x1155	4450lm	3.55	4PCS
GL60120-60W-P	60W	595*1195*23.5	555x1155	8000lm	6.80	2PCS

CCT — 3000K 4000K 5000K 5700K

Finish — White

PL-AZ Panel light

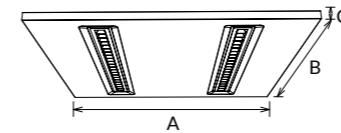

PL-AZ panel light is direct lighting with louver anti-glare design with external driver, adopting high lumen SMD led and special lens which provide high light efficiency and uniform light output, SPCC housing plus PC module form ideal combination of stylish design, the luminous module can be replaced, which ensure the easy maintenance.it is a ideal replacement for traditional 3*24W HO T5 and 3*18W T8 fluorescent louver luminaries and side lit LED panel light.

- 90°
- IP20
- UGR<19
- DIM
- DALI
- 0-10V
- Flicker Free
- TUNABLE WHITE
- 3 in 1
- AC 220-240V
- PF≥0.9
- CRI≥80
- SAA
- RoHS
- CE

Code	Watt	Size(AxBxCmm)	Cut-out(±5mm)	Lumen(±5%)	N.W/pc(kgs)	Q'ty/CTN
PL6060-30W-AZ	30W	595x595x15	580x580	3450lm	3.20	4PCS
PL6060-35W-AZ	35W	595x595x15	580x580	3950lm	3.20	4PCS
PL6262-30W-AZ	30W	620x620x15	605x605	3450lm	3.50	4PCS
PL6262-35W-AZ	35W	620x620x15	605x605	3950lm	3.50	4PCS
PL30120-30W-AZ	30W	1195x295x17.5	1180x280	3450lm	3.60	4PCS
PL30120-35W-AZ	35W	1195x295x17.5	1180x280	3950lm	3.60	4PCS

CCT — 3000K 4000K 5000K 5700K

Finish — White

PL-AK Panel light

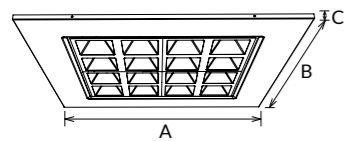

PL-AK panel light is a module design with external driver, featuring PC louver reflectors to help reduce UGR, offers the ideal combination of stylish design and optimum performance for both task and general lighting; Module replaceable, easy to install and maintain. Available in various installation ways: recessed, suspended and surface mounted, and can replace the traditional panel light.

-
-
-
-
-
-
-
-
-
-
-
-
-
-
-
-
-
-

Code	Watt	Size(AxBxCmm)	Cut-out(±5mm)	Lumen(±5%)	N.W/pc(kgs)	Q'ty/CTN
PL3060-18W-AK	18W	595x295x36	580x280	2010lm	1.55	4PCS
PL6060-25W-AK	25W	595x595x36	580x580	3552lm	2.90	4PCS
PL6060-30W-AK	30W	595x595x36	580x580	3660lm	2.90	4PCS
PL6060-36W-AK	36W	595x595x36	580x580	3900lm	2.90	4PCS
PL6262-36W-AK	36W	620x620x36	605x605	3900lm	3.30	4PCS
PL30120-36W-AK	36W	1195x295x36	1180x280	3920lm	2.95	4PCS

CCT 3000K 4000K 5000K 5700K

Finish White

PL008 Panel light

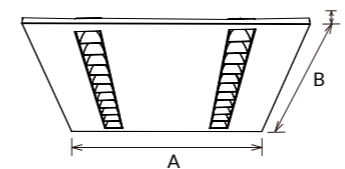

PL008 panel light is direct lighting with louver anti-glare design with external driver, adopting high lumen SMD led and special lens which provide high light efficiency and uniform light output, CCT switchable is available, it is a ideal replacement for traditional 3*24W HO T5 and 3*18W T8 fluorescent louver luminaries and side lit LED panel light.

Reflector



Code	Watt	Size(AxBxCmm)	Cut-out(±5mm)	Lumen(±5%)	N.W/pc(kgs)	Q'ty/CTN
PL008-3060-15W	15W	295x595x31.5	570x270	1800lm	1.47	5PCS
PL008-6060-30W	30W	595x595x31.5	570x570	3600lm	2.70	5PCS
PL008-6262-30W	30W	620x620x31.5	595x595	3600lm	2.90	5PCS
PL008-30120-30W	60W	295x1195x31.5	1170x270	3600lm	2.74	5PCS
PL008-60120-55W	60W	595x1195x31.5	1170x570	6700lm	5.28	2PCS
PL008-3060-12W	12W	295x595x31.5	570x270	1700lm	1.47	5PCS
PL008-6060-25W	25W	595x595x31.5	570x570	3550lm	2.70	5PCS
PL008-6262-25W	25W	620x620x31.5	595x595	3550lm	2.90	5PCS
PL008-30120-25W	25W	295x1195x31.5	1170x270	3550lm	2.74	5PCS
PL008-60120-40W	40W	595x1195x31.5	1170x570	5700lm	5.28	2PCS

CCT 3000K 4000K 5000K 5700K

Finish White

-
-
-
-
-
-
-
-
-
-
-
-
-
-
-
-
-
-
-
-



PL-DE Panel light

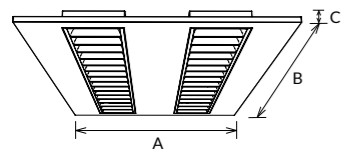

PL-DE is a new grill design with UGR<19.COI (Cyanosis Observation Index) compliant.Air slot available.

- ▶ UGR<19
- ▶ Flicker Free
- ▶ AC 220-240V PF≥0.9 CRI≥90
- ▶ SAA RoHS CE

Code	Watt	Size(AxBxCmm)	Cut-out(±5mm)	Lumen(±5%)	N.W/pc(kgs)	Q'ty/CTN
PL3060-DE	13W	292x592x48	282x582	1400lm	2.60	4PCS
PL3012-DE	28W	1192x292x48	582x582	2960lm	2.99	4PCS
PL4012-DE	28W	1192x392x48	282x1182	2960lm	2.73	2PCS
PL6060-DE	28W	592x592x48	382x1182	2960lm	5.41	4PCS
PL3015-DE	40W	1492x292x48	282x1482	4320lm	3.73	4PCS

CCT
3000K
4000K
5000K
5700K

Finish
White

Air slot version frame available.

Replaceable modular design for convenient maintenance.

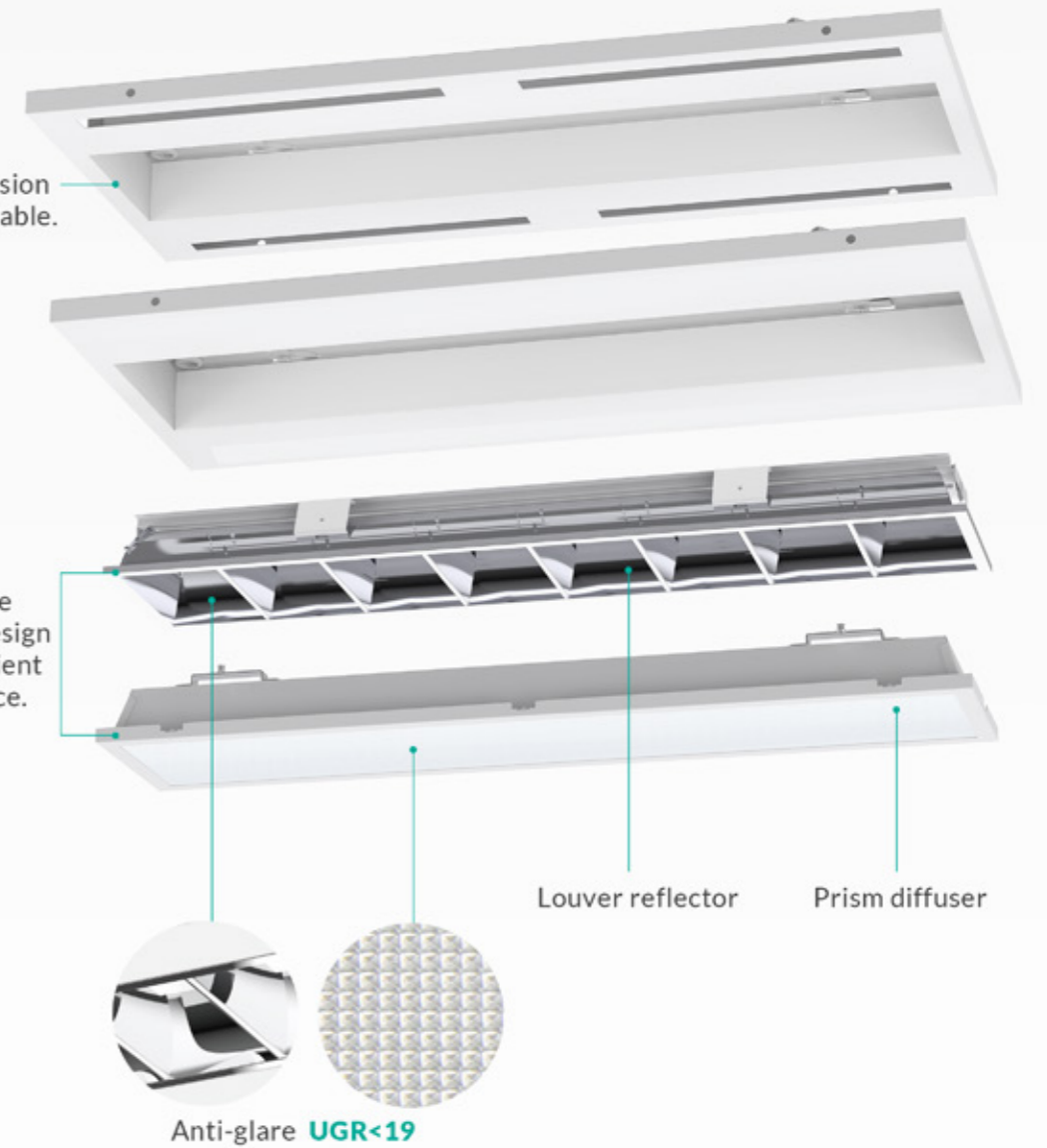

PL-DE MODULAR DESIGN LED PANEL

Replaceable modular design for convenient maintenance

GL-AA Backlit Troffer light

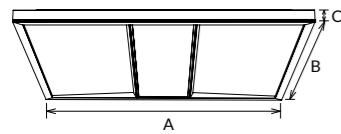

GL-AA backlit troffer is anti-glare design, the compact and seamless splicing make it a great looking. It adopts anti-glare prism plate to reach UGR<19, could be interchangeable CCT (3000K+4000K+5700K) with slide switch. 100lm/W and 125lm/W for options.

- ▶
- ▶
- ▶
- ▶
- ▶

Code	Watt	Size(AxBxCmm)	Cut-out(±5mm)	Lumen(±5%)	N.W/pc(kgs)	Q'ty/CTN
GL6060-36W-AA	36W	595x595x40	570x570	3700lm	2.60	5PCS
GL30120-36W-AA	36W	1195x295x40	1170x270	3700lm	2.99	5PCS
GL6262-36W-AA	36W	620x620x49	590x590	3700lm	2.73	5PCS
GL60120-60W-AA	60W	1195x595x49	1170x570	6500lm	5.41	2PCS
GL6060-30W-AA NEW	30W	595x595x40	570x570	4000lm	2.60	5PCS
GL30120-30W-AA NEW	30W	1195x295x40	1170x270	3670lm	2.99	5PCS
GL6262-30W-AA NEW	30W	620x620x49	590x590	3980lm	2.73	5PCS
GL60120-50W-AA NEW	50W	1195x595x49	1170x570	6670lm	5.41	2PCS

CCT — 3000K 4000K 5000K 5700K

Finish — White

GL002 Troffer light

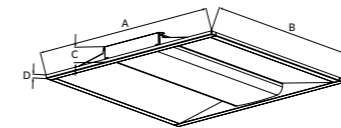

GL002 is an LED troffer light with external driver, it adopts secondary optical designed and special treatment diffuser to achieve more uniform and softer light, providing more comfortable visual experience. Luminous efficiency is 105lm/W.

- ▶
- ▶
- ▶
- ▶

Code	Watt	Size(AxBxCmm)	Cut-out(mm)	Lumen(±5%)	N.W/pc(kgs)	Q'ty/CTN
GL002-6060-32W	32W	595x595x54	/	3800lm	2.37	4PCS
GL002-30120-32W	32W	295x1195x54	/	3800lm	2.53	4PCS

CCT — 3000K 4000K 5000K 5700K

Finish — White



PL-DF Panel light

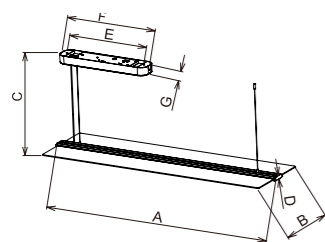

This panel light is a frameless, transparent and 360 degree lighting design, which provides a great visual aesthetic feeling. Adopt high lumen SMD light source, the 4mm transparent PMMA LGP makes a uniform, soft lighting output and reaches anti-glare UGR<19. 6063 aluminum heat sink makes an excellent thermal management. Magnetic mounting box can also save much time for installation.

- ▶ 120°
- ▶ 50%
- ▶ IP20
- ▶ UGR<19
- ▶ DIM
- ▶ DALI
- ▶ Flicker Free
- ▶ SMD SWITCH 2 in 1
- ▶ AC 200-240V
- ▶ PF≥0.9
- ▶ CRI≥80
- ▶ SAA
- ▶ RoHS
- ▶ CE

Code	Watt	Size(AxBxCxDxExFxGmm)	Lumen(±5%)	N.W/pc(kgs)	Q'ty/CTN
PL35120-40W-DF	40W	1200x350x1500x19x422x480x43	4800lm	4.50	2PCS
PL35120-40W-DF-D	40W	1200x350x1500x19x422x480x43	4800lm	4.50	2PCS
PL35120-60W-DF	60W	1200x350x1500x19x422x480x43	7300lm	4.50	2PCS

CCT — 3000K — 4000K — 5700K

Finish — White



PL-DB Panel light

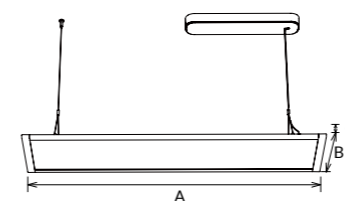

PL-DB panel light is an Up & down emitting panel with external driver, novel design without any screw make it a special and good looking panel. Besides, it is an anti-glare UGR<19 design without Prism plate, this is a new tendency for high end market. Magnetic mounting box can also save much time for installation, Triac dim and DALI dimming options.

- ▶ 110°
- ▶ IP20
- ▶ UGR<19
- ▶ DIM
- ▶ DALI
- ▶ Flicker Free
- ▶ AC 220-240V
- ▶ PF≥0.9
- ▶ CRI≥80
- ▶ SAA
- ▶ RoHS
- ▶ CE

Code	Watt	Size(AxBxCmm)	Lumen(±5%)	N.W/pc(kgs)	Q'ty/CTN
PL30120-30W-DB	30W	1200x300x16.5	3060lm	3.76	2PCS
PL30120-40W-DB	40W	1200x300x16.5	4000lm	3.76	2PCS
PL30120-50W-DB	50W	1200x300x16.5	4950lm	3.76	2PCS

CCT — 3000K — 4000K — 5000K — 5700K

Finish — White



PL-DG Panel light

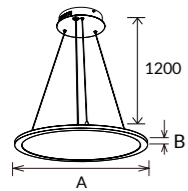

PL-DG pendant panel light is a translucent and 35% up & 65% down lighting design, which can be used in many applications as a decorative light. It adopts high quality diffuser and 3.0T PMMA light guide plate which provide a high transmittance rate and uniform light. Steel wire mounted on the edge of frame is more convenient and much safer. 300mm, 400mm, 500mm, 600mm size options. Interchangeable CCT (3000/4000/5700K) with slide switch is available.

- ▶ 120° / 120°
- ▶ 35% / 65%
- ▶ IP20
- ▶ DIM
- ▶ DALI
- ▶ 0-10V
- ▶ Flicker Free
- ▶ AC 220-240V
- ▶ PF ≥ 0.9
- ▶ CRI ≥ 80
- ▶ SAA
- ▶ RoHS
- ▶ CE

Code	Watt	Size(AxBmm)	Lumen(±5%)	N.W/pc(kgs)	Q'ty/CTN
PL3012-18W-DG	18W	Ø300x11.5	1820lm	1.25	5PCS
PL4012-35W-DG	35W	Ø400x11.5	3605lm	1.75	4PCS
PL5012-40W-DG	40W	Ø500x11.5	4120lm	2.25	4PCS
PL6012-60W-DG	60W	Ø600x11.5	6210lm	3.15	2PCS

CCT ——— 3000K — 4000K — 5000K — 5700K

Finish ——— White

PL-DG PENDANT LED ROUND PANEL

UP & DOWN translucent lighting 35%:65%

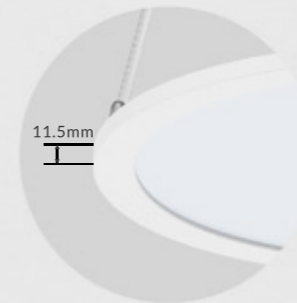

Slim transparent body design

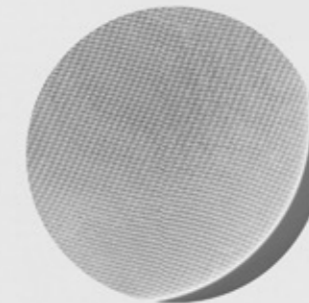

PMMA LGP

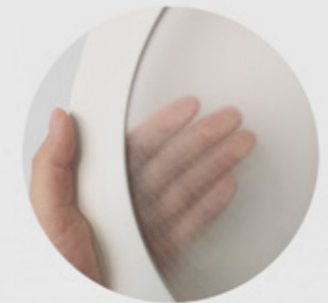

Translucent lighting area can offer a great decorative effect

LED Panel light



PL-W Panel light

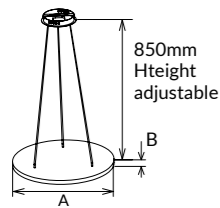

PL-W LED pendant decorative light with high quality diffuser and 3T PMMA LGP. 300mm, 400mm, 500mm, 600mm and 780mm diameter for options. Various installation ways include suspended, surface mounted and recessed.

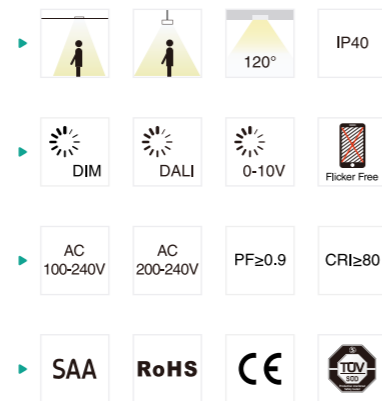

Code	Watt	Size(AxBmm)	Lumen(±5%)	N.W/pc(kgs)	Q'ty/CTN
PL3012-18W-W	18W	Ø300x12	1560lm	2.50	5PCS
PL4012-25W-W	25W	Ø400x12	2070lm	3.10	4PCS
PL4012-35W-W	35W	Ø400x12	2900lm	3.10	4PCS
PL5012-30W-W	30W	Ø500x12	2520lm	4.20	4PCS
PL5012-35W-W	35W	Ø500x12	2900lm	4.20	4PCS
PL6012-35W-W	35W	Ø600x12	3040lm	4.34	2PCS
PL6012-45W-W	45W	Ø600x12	3600lm	4.34	2PCS
PL8012-60W-W	60W	Ø780x20	5430lm	6.10	2PCS
PL8012-80W-W	80W	Ø780x20	7460lm	6.90	2PCS

CCT 3000K 4000K 5000K 5700K

Finish White



PL-DD Panel light

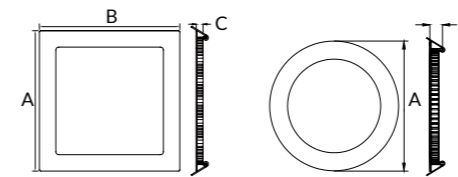

PL-DD is small size panel with complete diameter options. 2835SMD LED chip and PMMA LGP offer a great light transmittance and light output. Adopt die-casting aluminum frame which provides a great thermal management. External driver comes with triac dim, it shares great popularity by perfect dimming range and great compatibility with worldwide dimmers. The ultra slim profile fits perfectly for all working places.

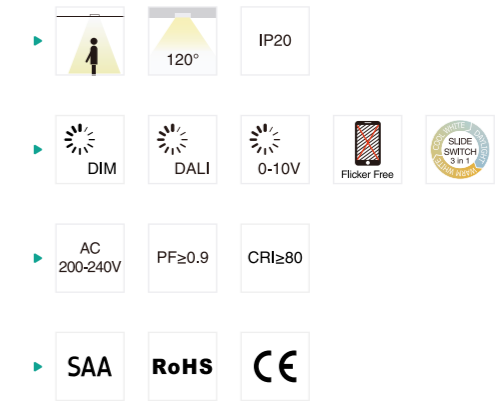

Code	Watt	Size(AxBxCmm)	Cut-out(±5mm)	Lumen(±5%)	N.W/pc(kgs)	Q'ty/CTN
PL1212-7W-DD	7W	120x120x21	105x105	580lm	0.24	36PCS
PL1515-9W-DD	9W	146x146x21	127x127	810lm	0.28	24PCS
PL1717-12W-DD	12W	171x171x21	155x155	1070lm	0.34	20PCS
PL2222-18W-DD	18W	224x224x21	205x205	1580lm	0.52	12PCS
PL3030-24W-DD	24W	300x300x21	277x277	2500lm	0.88	12PCS
PL1221-7W-DD	7W	Ø120x21	Ø108-113	580lm	0.20	36PCS
PL1521-9W-DD	9W	Ø145x21	Ø127-133	810lm	0.24	24PCS
PL1721-12W-DD	12W	Ø170x21	Ø157-162	1050lm	0.29	20PCS
PL2021-15W-DD	15W	Ø200*21	Ø177-182	1470lm	0.35	12PCS
PL2221-18W-DD	18W	Ø224x21	Ø205-212	1680lm	0.42	12PCS
PL2421-22W-DD	22W	Ø238*21	Ø224-228	2150lm	0.50	12PCS
PL3021-24W-DD	24W	Ø300x21	Ø282-288	2500lm	0.71	12PCS

CCT 3000K 4000K 5000K 5700K 6500K

Finish White

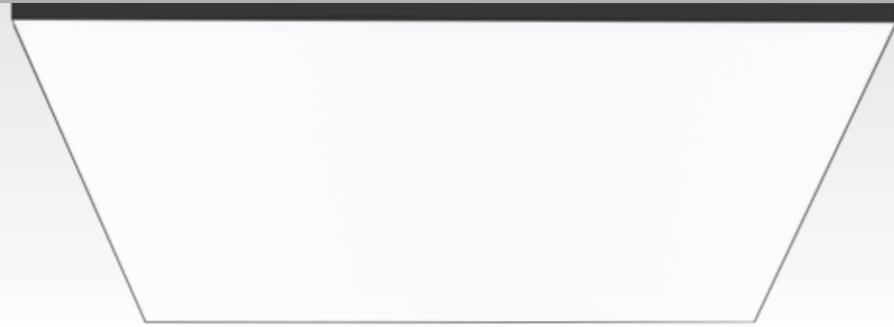

PL-EA Panel light

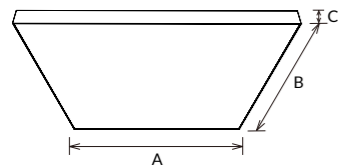

PL-EA is a big size panel with simple and elegant design. CRI>90, adopting high quality SMD led and secondary light distribution design to provide uniform light output. Fireproof B1 grade soft film as luminous cover and 0.5mm thickness backboard make this panel looks very reliable.

- ▶
- ▶
- ▶
- ▶

Code	Watt	Size(AxBxCmm)	Lumen(±5%)	N.W/pc(kgs)	Q'ty/CTN
PL120120-60W-EA	60W	1200x1200x110	4800lm	11	1PCS
PL120240-120W-EA	120W	1200x2400x110	9600lm	21	1PCS
PL120300-180W-EA	180W	1200x3000x110	14400lm	27	1PCS
PL150150-80W-EA	80W	1500x1500x110	6400lm	17	1PCS
PL150300-240W-EA	240W	1500x3000x110	19200lm	34	1PCS

CCT ——— 3000K 4000K 5000K 5700K Finish ——— Black

Installation accessories ——— Suspension kit Surface mounted kit

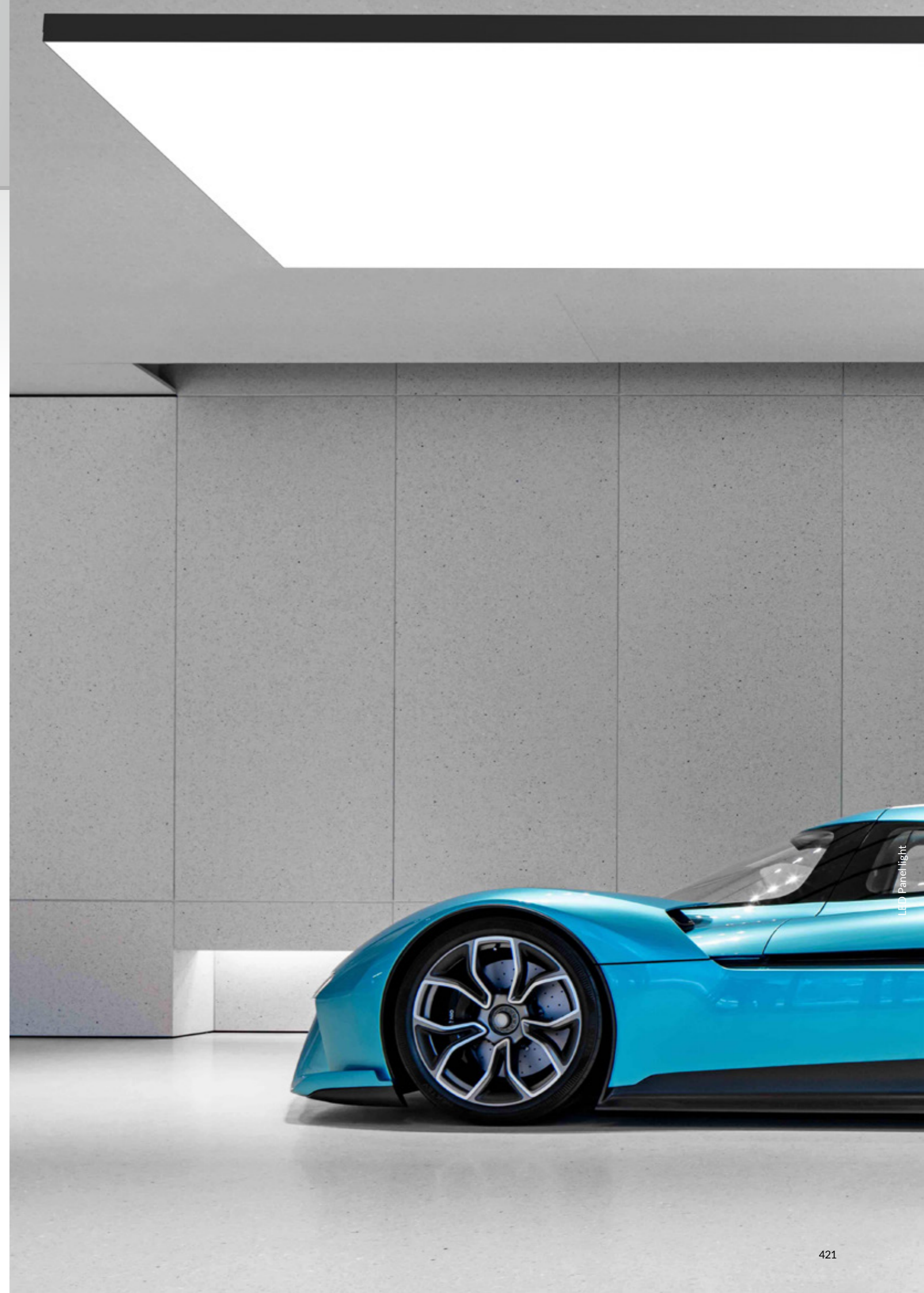

Panel Light installation accessories

Assembled surface mounted frame



DIY surface mounted frame

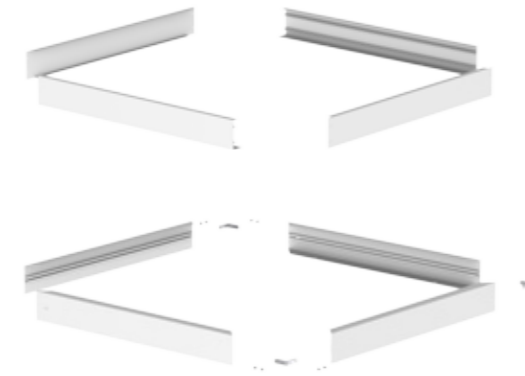
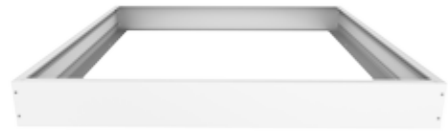

Assembled embedded mounted frame



Suspending Kits



Recessed Installation Clips



Integrated Recessed Installation Clips





OL02 LED freestanding luminaire

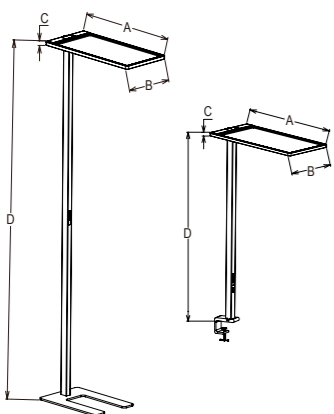

This OL02 freestanding lamp is composed of three parts: flat lamp body, lamp pole and lamp base. With a precise optical design (UGR<14, up 75% & down 25% lighting), it can ensure a more uniform and more comfortable lighting effect. Lamp Pole with: Plug, touchable 0-10V dimmer, light sensor and PIR sensor module.

- ▶ 75%
25% UGR<14
- ▶ 0-10V Flicker Free
- ▶ AC 220-240V PF≥0.93 CRI≥80
- ▶ SAA RoHS CE

Code	Watt	Size(AxBxCxDmm)	Lumen(±5%)	N.W/pc(kgs)	Q'ty/CTN
OL02/B-75W-DOS	75W	720x340x21.5x1900	8200lm	Flat lamp body:2.70 Lamp pole:3.10 Lamp base:6.70	6PCS 6PCS 2x3PCS
OL02C/D-75W-DOS	75W	720x340x21.5x1188	8200lm	Flat lamp body:2.70 Lamp pole:3.00	6PCS 6PCS

CCT 3000K-5700K

Finish White Black

- Indirect lighting and direct lighting (500~700LUX on the desk)
- PMMA LGP with Prismatic diffuser to achieve UGR<14 ideal for office lighting.

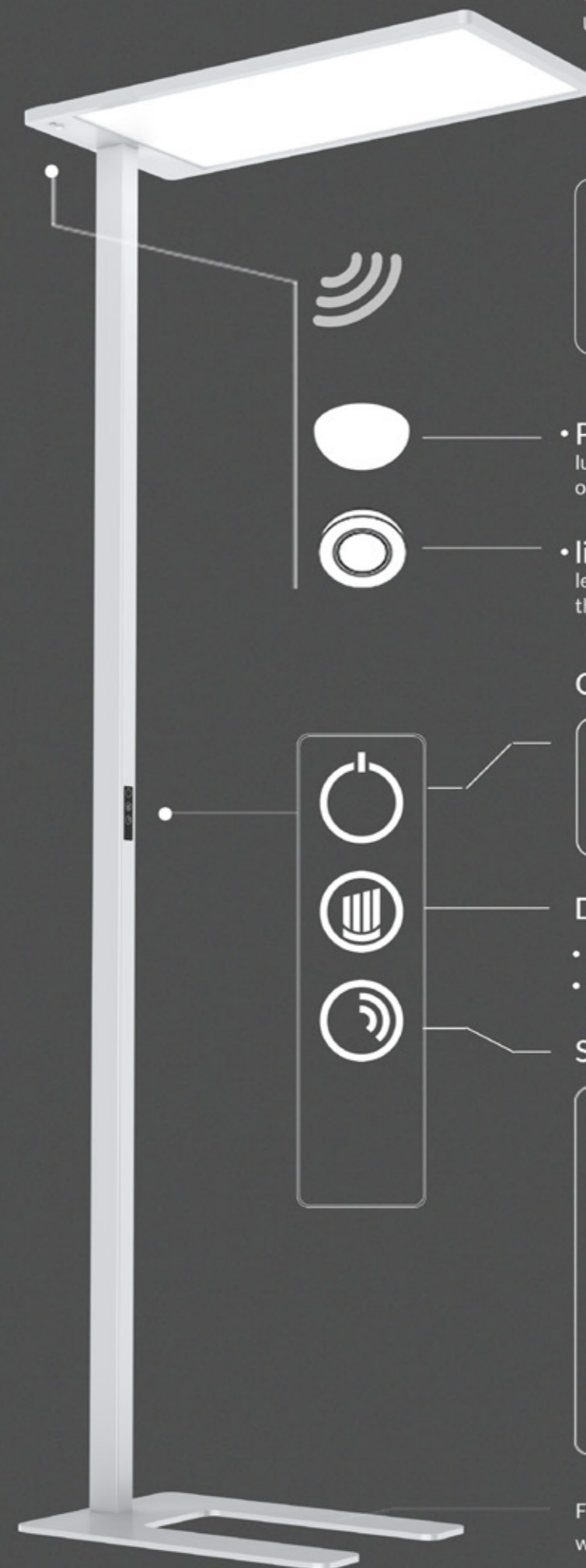

STATUS



• **PIR sensor** detector automatically switches the luminaire on and then switches it off when there is no one in the room.

• **light sensor** continuously measures the illuminance level on the desk and dims the light itself depending on the amount of available daylight and artificial lighting.

ON/OFF

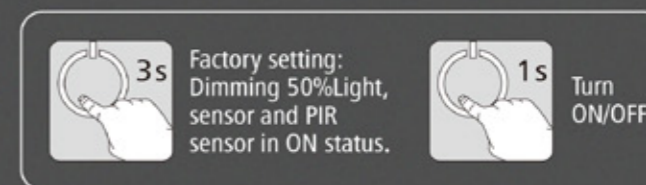

Dimming button

- Short press in 1s, brightness will increase/ decrease 5%
- Long press brightness will increase/ decrease continually

Sensor



Flat lamp base with reliable stability, saving space and widely work with office furniture



OL06 LED freestanding luminaire

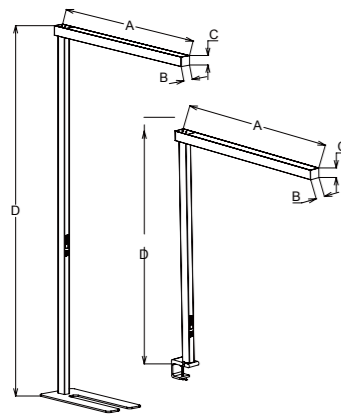

This OL06 free-standing luminaire is composed of three parts. OL06A is for floor standing, OL06B is for desk installation. OL06C is for floor standing with smart control, OL06D is for desk installation with smart control. Direct and indirect optic design, UGR<16, up 75% & down 25% lighting, up to 125lm/W high light efficiency. 0-10V dimmer, light sensor, PIR sensor module and USB connector are available. The configuration of the luminaire is triggered by pressing a button. The lighting control modules are interchangeable, which is very suitable for modern office environments.

- ▶ 80°x50° 60°x60°x15°
- ▶ IP20 UGR<16
- ▶ 0-10V Flicker Free CASAMBI
- ▶ Smart Lighting
- ▶ AC 220-240V PF≥0.93 CRI≥80
- ▶ SAA RoHS CE

Code	Watt	Size(AxBxCxDmm)	Lumen(±5%)	N.W/pc(kgs)	Q'ty/CTN
OL06A-80W -DOS	80W	1060x60x53x2026	10500lm	Flat lamp body+Lamp pole:5.70 Lamp base:6.80	3PCS 3PCS
OL06B-80W-DOS	80W	1060x60x53x1276	10500lm	5.10	3PCS
OL06C-85W-B	85W	1060x60x53x2026	10500lm	Flat lamp body+Lamp pole:5.70 Lamp base:6.80	3PCS 3PCS
OL06C-75W-B1	75W	1060x60x53x2026	10500lm	Flat lamp body+Lamp pole:5.70 Lamp base:6.80	3PCS 3PCS
OL06D-85W-B	85W	1060x60x53x1276	10500lm	5.10	3PCS
OL06D-75W-B1	75W	1060x60x53x1276	10500lm	5.10	3PCS

CCT 3000K 4000K 5000K 5700K

Finish White



OL07 LED freestanding luminaire

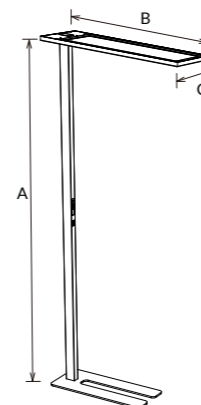

OL07 LED freestanding luminaire with professional version and intelligent version. The professional version could be PIR sensor and daylight sensor. The intelligent version could be CCT changeable and dim by CASAMBI. 120 degree beam angle and UGR<16 could provide uniform lighting performance.

- ▶ 120°
- ▶ IP20 UGR<16
- ▶ 0-10V Flicker Free CASAMBI
- ▶ AC 220-240V PF≥0.9 CRI≥80
- ▶ SAA RoHS CE

Code	Watt	Size(AxBxCmm)	Lumen(±5%)	N.W/pc(kgs)	Q'ty/CTN
OL07A-75W-DOS	75W	1925x920x300	7500lm	14	3PCS
OL07A-100W-DOS	100W	1925x920x300	10000lm	14	3PCS
OL07B-85W-B	85W	1925x920x300	8500lm	14	3PCS
OL07B-100W-B	100W	1925x920x300	10000lm	14	3PCS
OL07B-75W-B1	75W	1925x920x300	7500lm	14	3PCS
OL07B-100W-B1	100W	1925x920x300	10000lm	14	3PCS

CCT 3000K 4000K 5000K

Finish White



OL01 LED freestanding luminaire

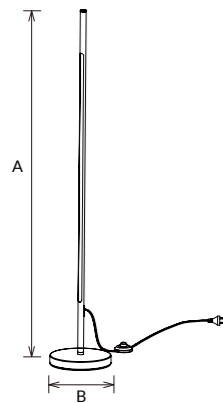

OL01 is a freestanding light combines modern industrial style, the unique shape and simple design perfectly fit the aesthetic concept of modern society. It adopts Tuya WIFI+2.4G intelligent technology, create various atmospheres, can switch to different lighting scenes according to your needs. Supporting both smart phone control and remote control, make it very convenient and easy control for different users. The slender body, plug and play, makes it convenient for different position.

- ▶ 120° IP20
- ▶ Flicker Free
- ▶ AC 200-240V PF≥0.9 CRI≥80
- ▶ SAA RoHS CE

Code	Watt	Size(AxBmm)	Lumen(±5%)	N.W/pc(kgs)	Q'ty/CTN
OL01-15W -WG	15W	1600x182	1400lm	Base:2.2 Lamp Body:0.6	6PCS 18PCS

CCT 3000K-5700K

Finish White Black



LED freestanding luminaire



LED Linear & Batten Light

/Series/

LED batten series and linear light are more and more popular nowadays. The original design concept is to replace the LED tube. But LED batten is more decorative and elegant, while it also maintains high lumen efficiency. ELWA is committed to the design and development of LED battens for many years. Multiple functions are updated constantly: UGR<19, 100lm/W, 120lm/W, lighting up&down, as well as DALI or 0-10v dimmable system. Surface mounted, suspended and wall mounted are all available.

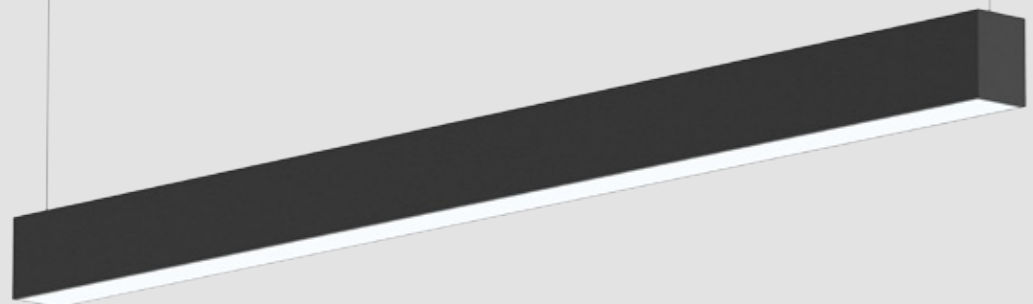

DB77A Linear light

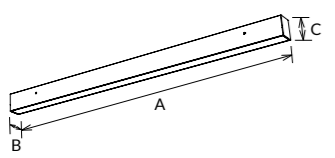

This linear fixture is a seamless splicing design with straight/corner/cross splicing connector. Two lamp cover options: Standard cover and anti-glare cover. Adopt high lumen SMD light source, flicker free and high efficiency driver make a better lumen. Aluminum housing provides an excellent thermal management. Functions: Down lighting, up&down lighting, adjustable CCT, emergency and sensor. Mounting design: Pendant/surface mounted/wall mounted/recessed/Track. Modular design: Replaceable driver and emergency module.

Code	Watt	Size(AxBxCmm)	Lumen(±5%)	N.W/pc(kgs)	Q'ty/CTN
DB77A-600-17W	17W	602x57x76	1680lm	1.70	6PCS
DB77A-600-22W	17W+5W	602x57x76	2250lm	1.70	6PCS
DB77A-1200-36W	36W	1212x57x76	3850lm	2.70	6PCS
DB77A-1200-45W	36W+9W	1212x57x76	4850lm	2.70	6PCS
DB77A-1500-45W	45W	1512x57x76	4850lm	3.50	6PCS
DB77A-1500-56W	45W+11W	1512x57x76	6000lm	3.50	6PCS

CCT — 3000K — 4000K — 5000K — 5700K

Finish — White — Black

Installation accessories

- Track ACC-DB77A-0500
- Suspension kit
- Wall mounted kit ACC-DB77A-0400
- Recessed ACC-DB66-0300
- Suspended with ceiling plate ACC-DB66-0200

DB77A | DIFFUSER TYPE

Upper Glowing Accessories

Connection accessories

- Blank fixture
- Corner "L"
- "T" shape
- Cross "+"
- Cross "Y" **NEW**

- Fast connector
- Upward luminaire
- Strengthen connector (used for suspended, track splicing)
- Splicing wiring connector
- DIY soft cover ACC-DB77A-53
- Prismatic cover ACC-DB77A-600/1200/1500-51
- Standard opal cover ACC-DB77A-600/1200/1500-50

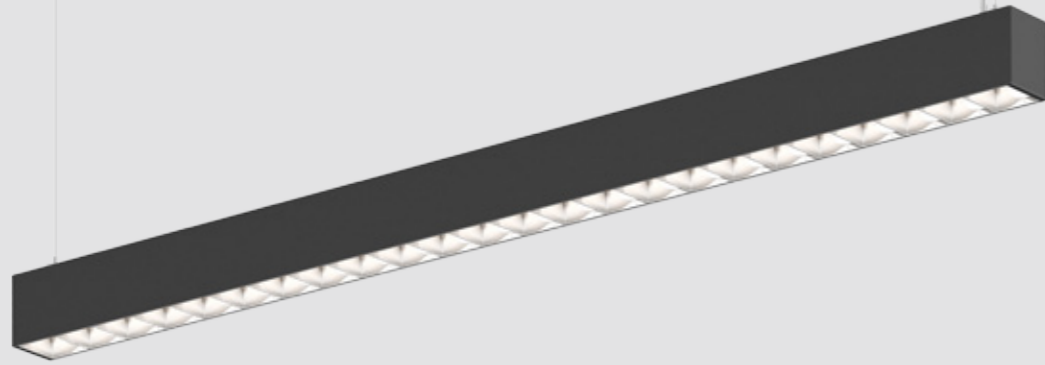

DB77B | GRILL REFLECTOR
UGR<19

DB77B Linear light

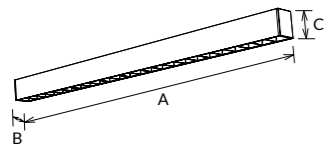

DB77B is a UGR<19 Linear Light with reflector design, adopt SMD light source. Aluminum housing provides an excellent thermal management. The splicing with L/T/X node connector, realize a very convenient connection. It can be Down lighting(CCT changeable is optional) or up&down lighting effect as per demands. Support 1-10V dimming, DALI dimming. Besides, Emergency function makes it wider applications. Multiple installation: Surface mounted/Recessed/Suspending.

- ▶
- ▶
- ▶

Code	Watt	Size(AxBxCmm)	Lumen(±5%)	N.W/pc(kgs)	Q'ty/CTN
DB77B-1200-36W	36W	Ø1212x57x76	3650lm	2.30	6PCS
DB77B-1200-48W	48W	Ø1212x57x76	4850lm	2.30	6PCS
DB77B-1500-45W	45W	Ø1512x57x76	4550lm	2.80	6PCS
DB77B-1500-60W	60W	Ø1512x57x76	6100lm	2.80	6PCS
DB77B-1800-54W	54W	Ø1812x57x76	5500lm	3.40	6PCS
DB77B-1800-65W	65W	Ø1812x57x76	6600lm	3.40	6PCS
DB77B-2400-72W	72W	Ø2412x57x76	7300lm	4.50	2PCS
DB77B-2400-96W	96W	Ø2412x57x76	9700lm	4.50	2PCS

CCT ——— 3000K — 4000K — 5000K — 5700K

Finish ——— White Black

Installation accessories ——— Track ACC-DB77A-0500 Suspension kit Wall mounted kit ACC-DB77A-0400 Recessed ACC-DB66-0300 Suspended with ceiling plate ACC-DB66-0200

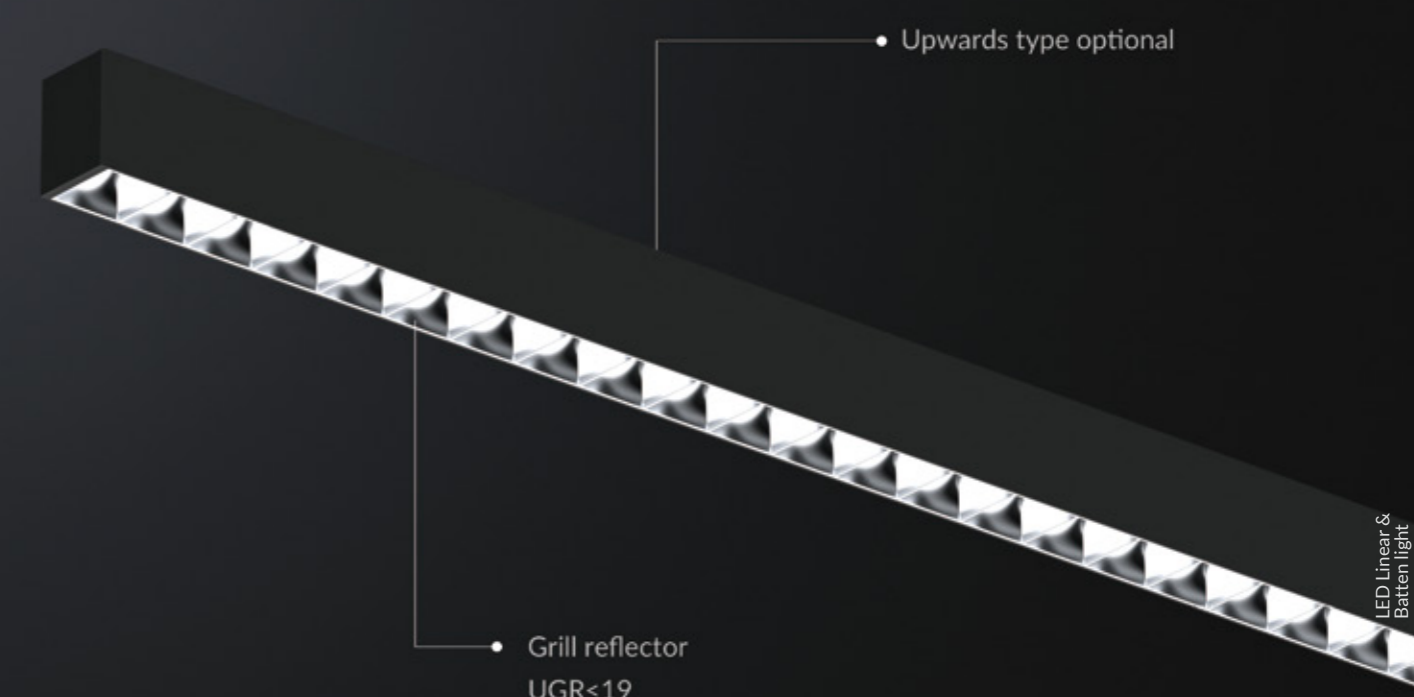

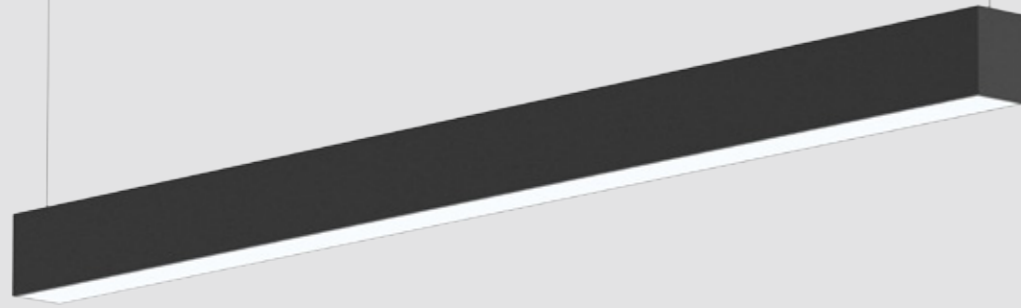

DB66 Linear light

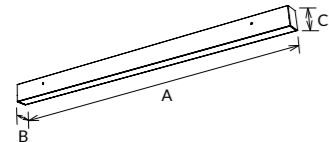

The DB66A/B is a new linkable design light. Adopt high lumen efficiency SMD LED and aluminum materials. Pendant, surface mounted, wall mounted installation available. Up and down light effect of wall mounted and pendant installation. Interchangeable CCT, DALI/0-10V dimming for options. Tridonic DALI driver available.

-
-
-
-
-
-

Code	Watt	Size(AxBxCmm)	Lumen(±5%)	N.W/pc(kgs)	Q'ty/CTN
DB66A-1200-36W	36W	1204x56x75	4000lm	2.75	6PCS
DB66A-1200-50W	50W	1204x56x75	5250lm	2.75	6PCS
DB66A-1500-42W	42W	1504x56x75	4800lm	3.35	6PCS
DB66A-1500-60W	60W	1504x56x75	6500lm	3.35	6PCS
DB66B-1200-36W	36W	1204x56x75	3950lm	2.75	6PCS
DB66B-1200-50W	50W	1204x56x75	5300lm	2.75	6PCS
DB66B-1500-42W	42W	1504x56x75	4600lm	3.35	6PCS
DB66B-1500-60W	60W	1504x56x75	6600lm	3.35	6PCS

CCT — 3000K — 4000K — 5000K — 5700K

Finish — White — Black

Installation accessories

- Track ACC-DB66-0500
- Suspension kit
- Wall mounted kit
- Recessed ACC-DB66-0300
- Suspended with ceiling plate ACC-DB66-0200
- Straight link connector
- ACC-DB66X-04
- ACC-DB66X-02
- ACC-DB66X-03
- ACC-DB66X-04

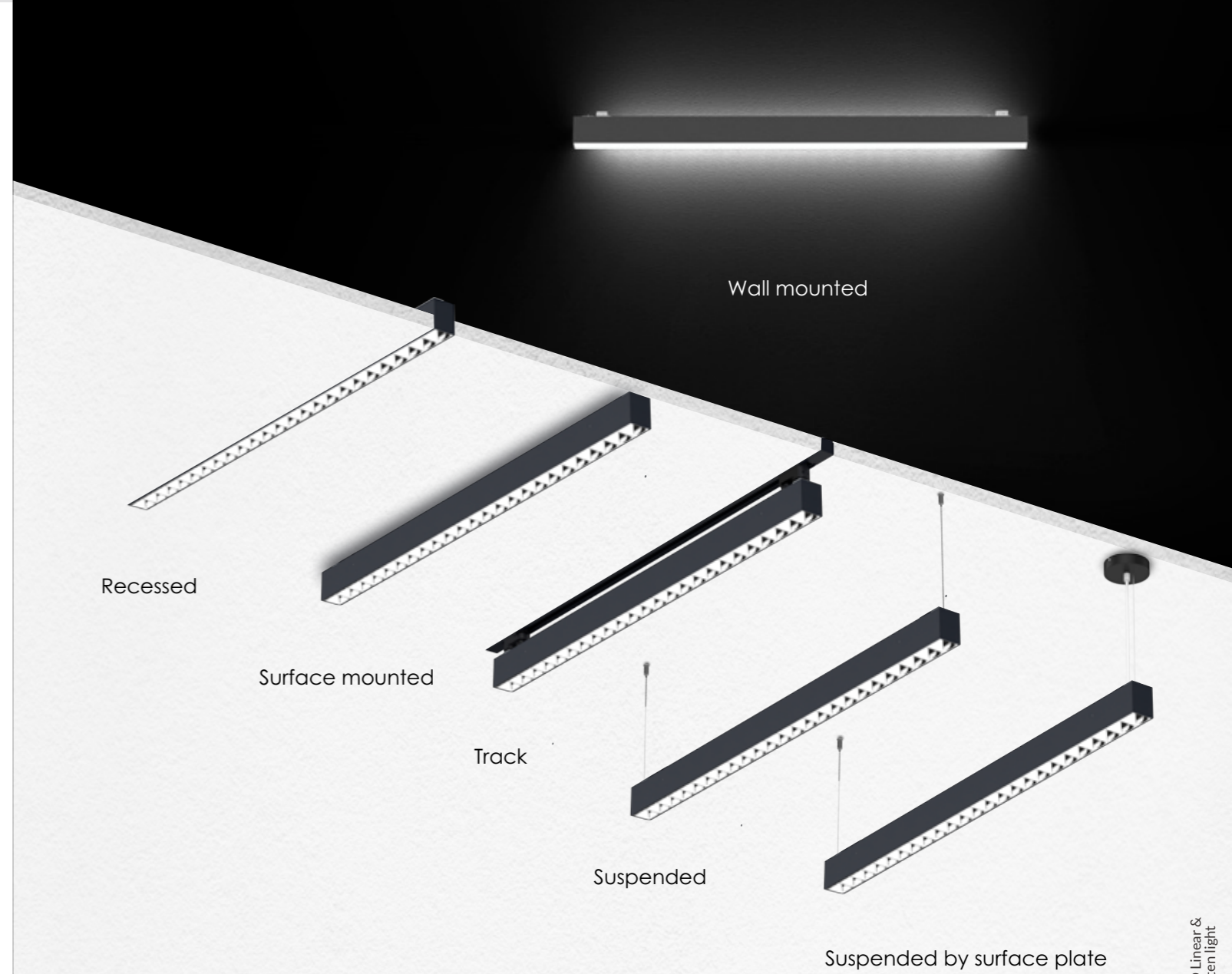

Multi-installation

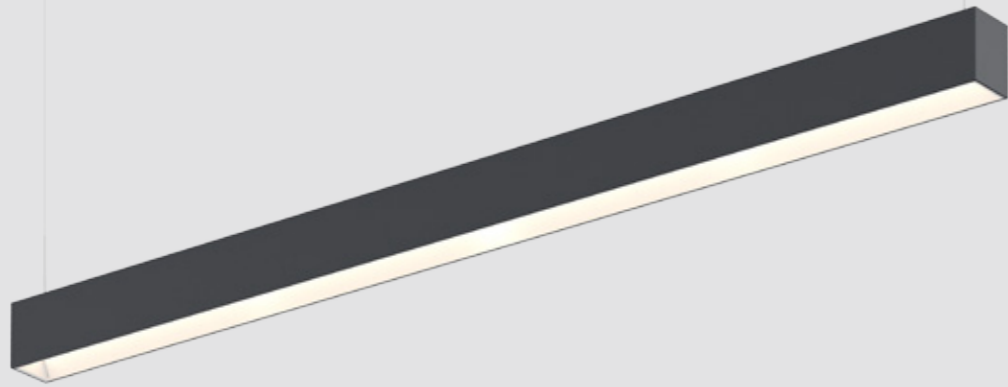

DB66D NEW Linear light

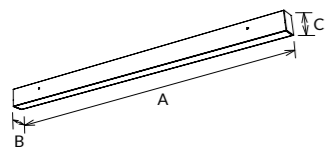

The DB66D is a new model upgraded based on DB66A, it adopts super high lumen efficiency SMD LED reach 140lm/w. Internal structure is special designed to control glare light achieve UGR<19. It also available with linking, DIY with up lighting module, 6 various installation methods.

- ▶
- ▶
- ▶
- ▶

Code	Watt	Size(AxBmm)	Cut-out(mm)	Lumen(±5%)	N.W/pc(kgs)	Q'ty/CTN
DB66D-1200-28W	28W	1204x56x75	1208x65	4000lm	2.75	6PCS
DB66D-1200-40W	40W	1204x56x75	1208x65	5550lm	2.75	6PCS
DB66D-1500-35W	35W	1504x56x75	1508x65	5100lm	3.35	6PCS
DB66D-1500-49W	49W	1504x56x75	1508x65	6850lm	3.35	6PCS

CCT ——— 3000K 4000K 5000K 5700K Finish ——— White Black

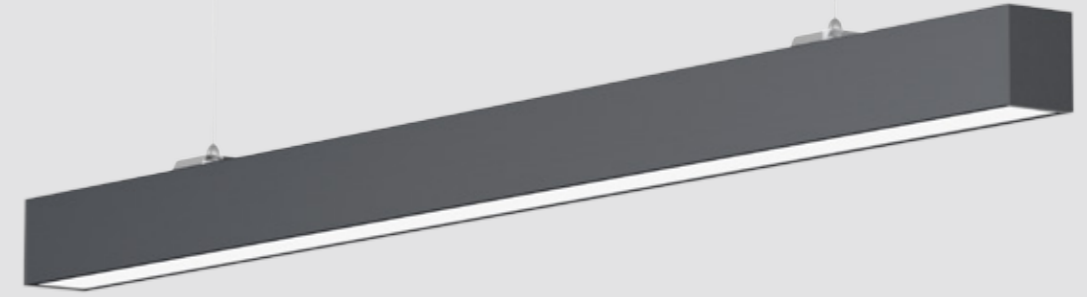
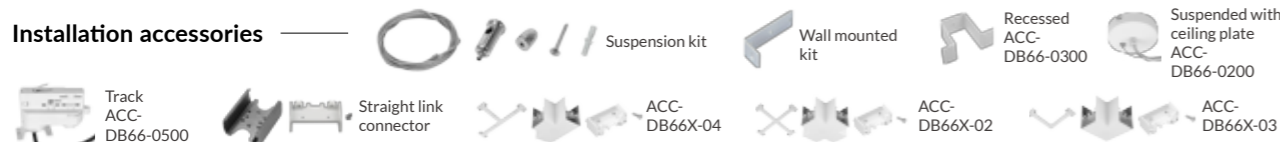

DB158 Linear light

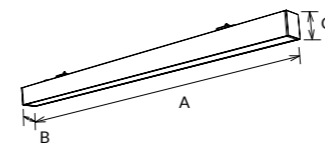

DB158 LED Linear Light is a perfect replacement for traditional tube. It adopt high lumen SMD light source, CCT changeable by dip switch. Aluminum housing provides an excellent thermal management. Opal PS diffuser provide high transparency. Loop in and loop out design, fast and convenient wiring. Flicker free driver. Support surface mounted and suspending installations.

- ▶
- ▶
- ▶
- ▶

Code	Watt	Size(AxBxCmm)	Lumen(±5%)	N.W/pc(kgs)	Q'ty/CTN
DB158-1200-40W	40W	1200x58.6x70	4400lm	1.55	6PCS
DB158-1200-40W-C3	40W	1200x58.6x70	4400lm	1.55	6PCS
DB158-1500-60W	60W	1500x58.6x70	6300lm	1.96	6PCS
DB158-1500-60W-C3	60W	1500x58.6x70	6600lm	1.96	6PCS

CCT ——— 3000K 4000K 5000K 5700K Finish ——— White Black

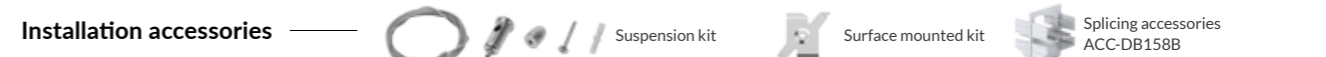

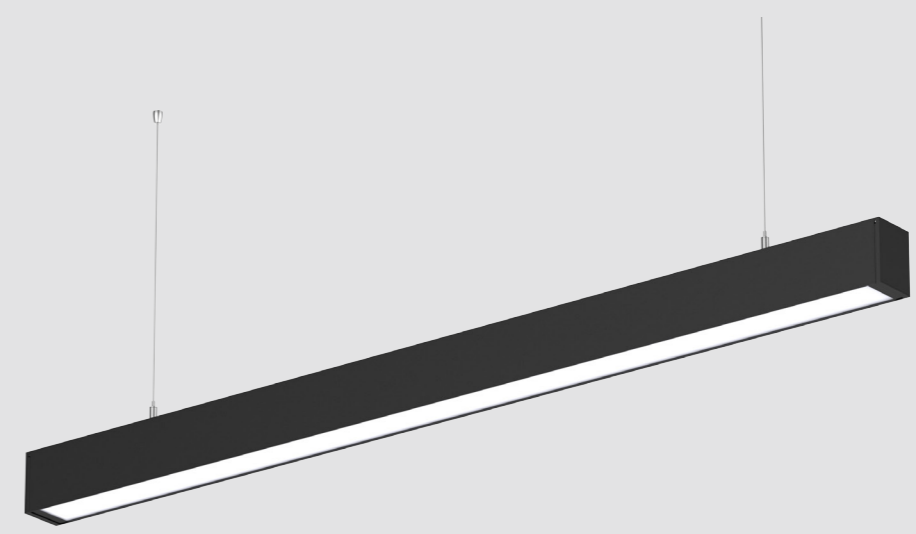
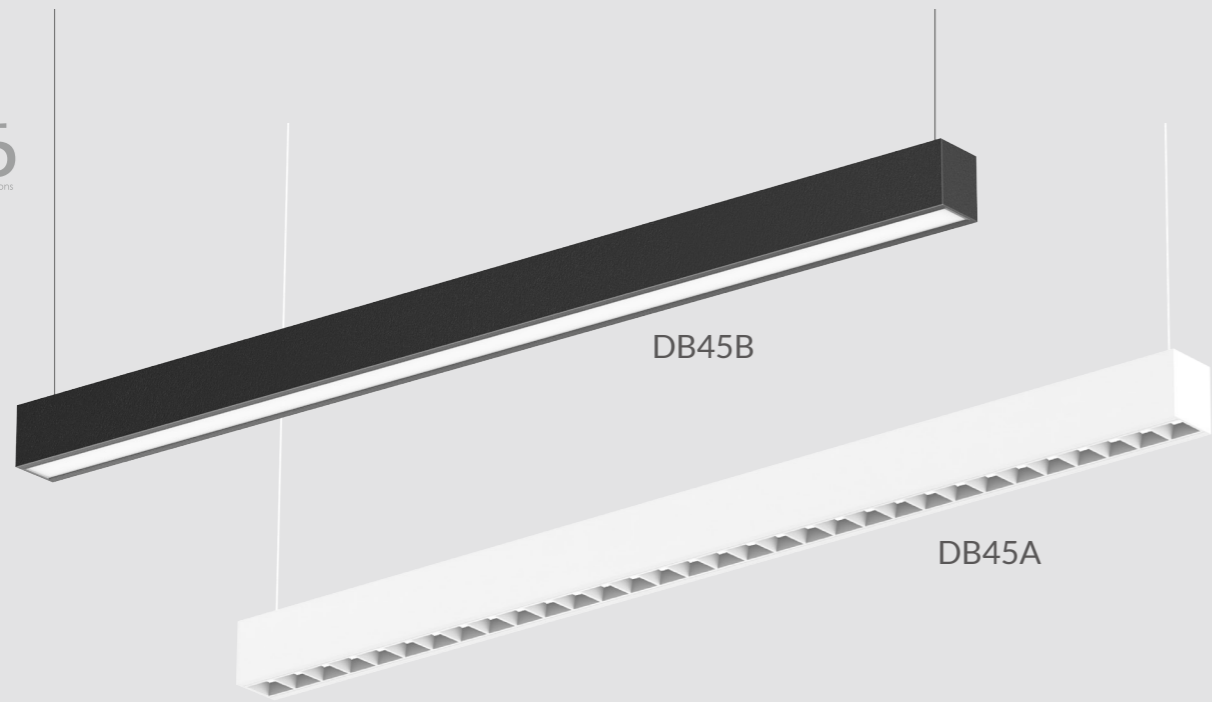

DB45A/B Linear light

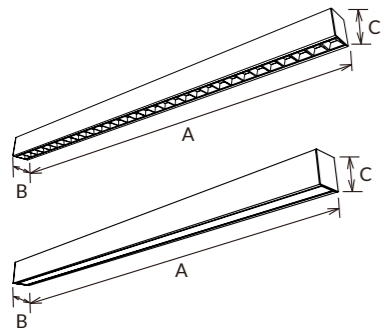

Module changeable design LED batten DB45 provides good heat dissipation, quality light and substantial energy saving. Suspended, surface mounted and splicing installation optional.

- ▶ 100° IP20
- ▶ Flicker Free SLIDE SWITCH 3 in 1
- ▶ AC 200-240V PF≥0.9 CRI≥80
- ▶ SAA RoHS CE

Code	Watt	Size(AxBxCmm)	Lumen(±5%)	N.W/pc(kgs)	Q'ty/CTN
DB45A-600-20W	20W	604x60x70	2500lm	1.15	12PCS
DB45A-1200-40W	40W	1204x60x70	5200lm	2.20	6PCS
DB45B-600-20W	20W	604x60x70	2400lm	1.15	12PCS
DB45B-1200-40W	40W	1204x60x70	4800lm	2.20	6PCS

CCT ——— 3000K 4000K 5000K 5700K

Finish ——— White Black

Installation accessories ——— Suspension kit Surface mounted kit Splicing kit

DB163 NEW Linear light

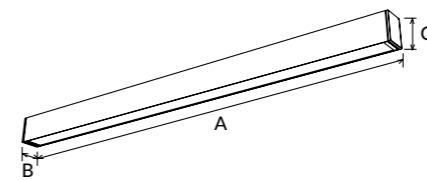

DB163 is IP54 water-proof design LED linear light, the high lumen LED makes it high lumen efficiency 125lm/W design. Aluminum body makes good heat dissipation which ensure a better and longer lifespan.

- ▶ 110° IP54
- ▶ 0-10V DALI Flicker Free SLIDE SWITCH 3 in 1
- ▶ AC 220-240V PF≥0.9 CRI≥80
- ▶ SAA RoHS CE

Code	Watt	Size(AxBxCmm)	Lumen(±5%)	N.W/pc(kgs)	Q'ty/CTN
DB163-1200-32W	32W	1215x57x76	4200lm	2.60	6PCS
DB163-1500-38W	38W	1515x57x76	5200lm	3.08	6PCS

CCT ——— 3000K 4000K 5000K 5700K

Finish ——— White Black Silver

Installation accessories ——— Suspension kit Splicing accessories ACC-DB163 Suspension splicing ACC-DB163 Surface mounted kit

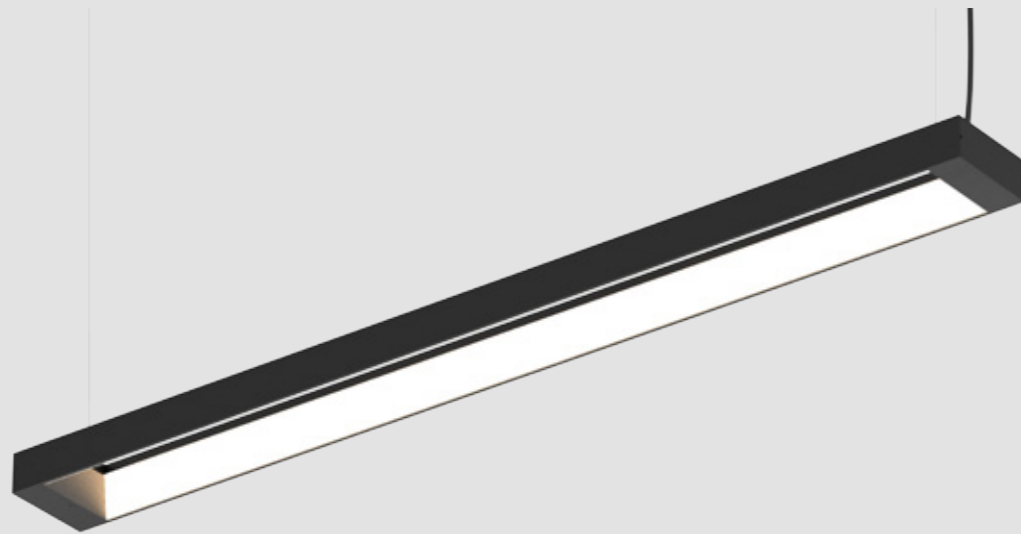

DB25 Linear light

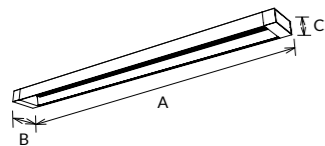

DB25 Linear with suspended and hollow design highlight the brand features, which makes the light go both up and down sides. The light for upside can reduce the extra light decoration.

- ▶ 120° IP20
- ▶ Flicker Free SIDE SWITCH 3 in 1 ((.))
- ▶ AC 200-240V PF≥0.9 CRI≥80
- ▶ SAA RoHS CE

Code	Watt	Size(AxBxCmm)	Lumen(±5%)	N.W/pc(kgs)	Q'ty/CTN
DB25-900-20W	20W	922x115x48.8	2000lm	1.46	6PCS
DB25-1200-40W	40W	1222x115x48.8	3800lm	1.86	6PCS
DB25-1600-60W	60W	1622x115x48.8	5800lm	2.47	6PCS

CCT — 3000K 4000K 5000K 5700K

Finish — White Black

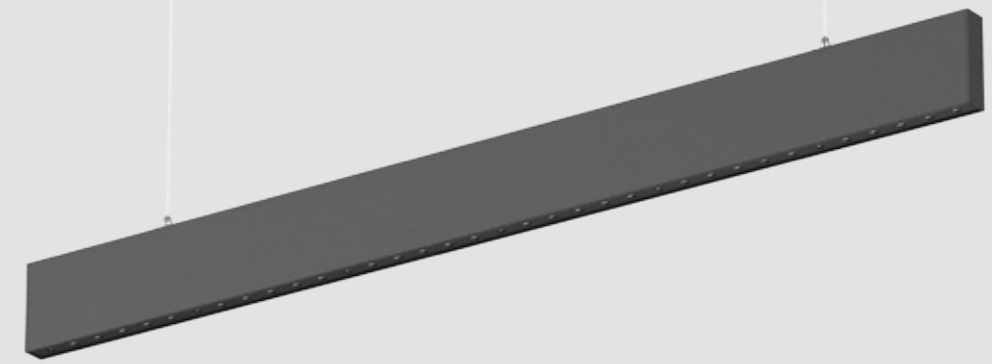

DB176 Linear light NEW

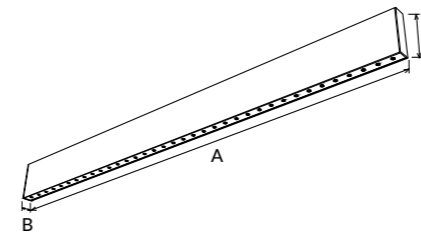

DB176 is anti-slim office linear light with 29mm width. AL6063 aluminium lamp body offers great thermal management. It is anti-glare design with UGR<19. Internal flicker free driver and triac/DALI dimming are available. Surface mounted and suspended for options.

- ▶ 30° IP20 UGR<19
- ▶ DIM DALI Flicker Free
- ▶ AC 220-240V PF≥0.9 CRI≥80
- ▶ SAA RoHS CE

Code	Watt	Size(AxBxCmm)	Lumen(±5%)	N.W/pc(kgs)	Q'ty/CTN
DB176-1200-28W	28W	1200x29x103	2250lm	1.87	6PCS
DB176-1600-34W	34W	1595x29x103	2800lm	2.37	4PCS
DB176-2000-40W/42W	40W(Non-dim/DALI) 42W(Triac)	1990x29x103	3100lm	2.87	4PCS

CCT — 2700K 3000K 4000K 5000K

Finish — White Black

Installation accessories

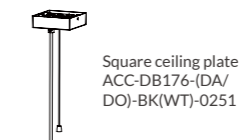
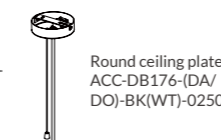

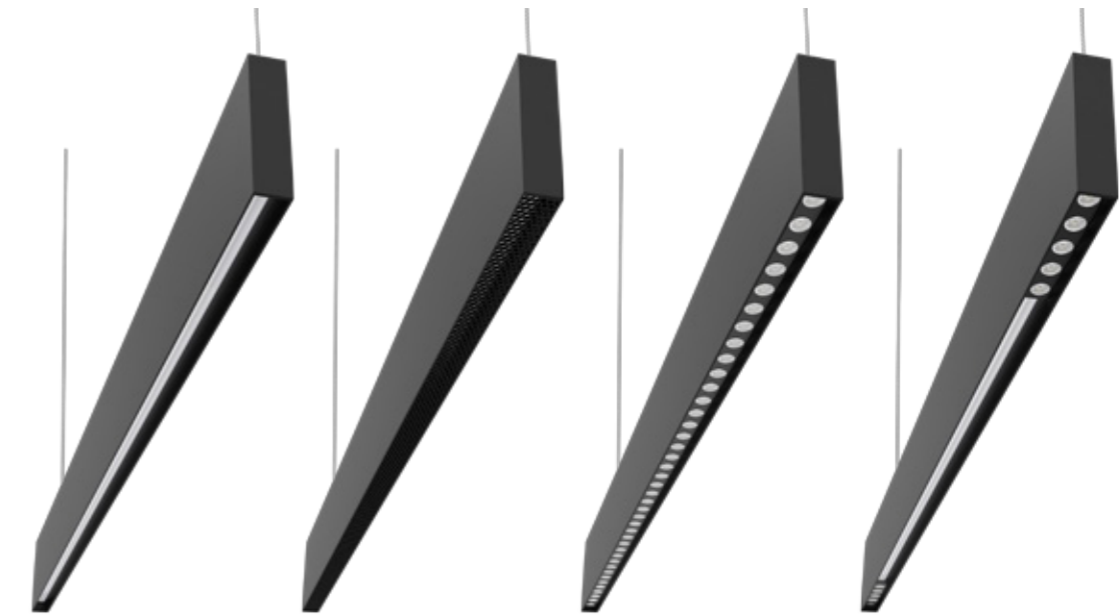
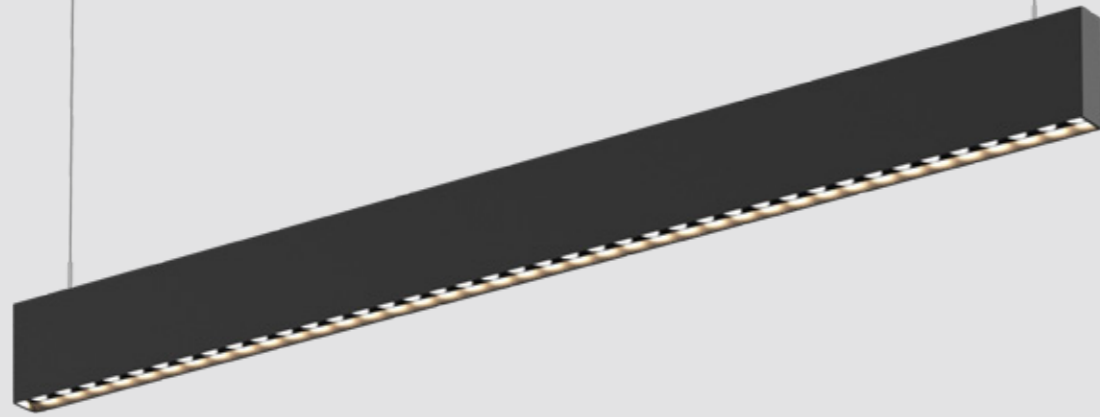

DB146A DB146B DB146C DB146D

DB146 Linear light

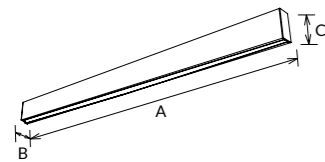

The DB146 batten has a minimalist appearance, adopts a variety of optics, it is perfect for a variety of use environment. Plug-in link and seamless splicing design effectively improve the installation time. Adopts 100lm/W & 120lm/W SMD high lumen efficiency as option ;flicker free driver with high efficiency. Up & down lighting design, up 20% & down 80%. Interchangeable CCT(3000K+4000K) and up lighting control with the same slide switch. DIY module design option: direct lighting module, honeycomb module, lens module, direct lighting + lens module.

-
-
-
-

Code	Watt	Size(AxBxCmm)	Lumen(±5%)	N.W/pc(kgs)	Q'ty/CTN
DB146A-600-18W	15W	605x34x105	1650lm	1.40	6PCS
DB146A-600-18W	15W+3W	605x34x105	2000lm	1.40	6PCS
DB146A-900-25W	20W	905x34x105	2200lm	2.10	6PCS
DB146A-900-25W	20W+5W	905x34x105	2700lm	2.10	6PCS
DB146A-1200-38W	30W	1205x34x105	4000lm	2.70	6PCS
DB146A-1200-38W	30W+8W	1205x34x105	4900lm	2.70	6PCS
DB146A-1500-50W	40W	1505x34x105	5200lm	3.20	6PCS
DB146A-1500-50W	40W+10W	1505x34x105	6400lm	3.20	6PCS
DB146B-1200-38W	30W	1205x34x105	1800lm	2.70	6PCS
DB146B-1200-38W	30W+8W	1205x34x105	2850lm	2.70	6PCS
DB146B-1500-50W	40W	1505x34x105	2400lm	3.20	6PCS
DB146B-1500-50W	40W+10W	1505x34x105	3700lm	3.20	6PCS
DB146C-1200-38W	30W	1205x34x105	4000lm	2.70	6PCS
DB146C-1200-38W	30W+8W	1205x34x105	4900lm	2.70	6PCS
DB146C-1500-50W	40W	1505x34x105	5200lm	3.20	6PCS
DB146C-1500-50W	40W+10W	1505x34x105	6400lm	3.20	6PCS
DB146D-1200-38W	30W	1205x34x105	4000lm	2.70	6PCS
DB146D-1200-38W	30W+8W	1205x34x105	4900lm	2.70	6PCS
DB146D-1500-50W	40W	1505x34x105	5200lm	3.20	6PCS
DB146D-1500-50W	40W+10W	1505x34x105	6400lm	3.20	6PCS

CCT ——— 3000K ——— 4000K ——— 5000K

Finish ——— White Black

Installation accessories ———

- Suspension kit ACC-DB146-0200
- Wall mounted kit ACC-DB146-0400
- Suspended with ceiling plate ACC-DB146-BK-0200
- Honeycomb ACC-DB146-BK
- Upward lighting module ACC-DB146-600/900/1200/1500
- Splicing ACC-DB146-01



DB142 Series

NEW LINEAR LIGHT

DB142 Linear light

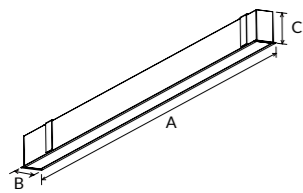

DB142 recessed linear light. Aluminum light housing provides good heat dissipation. It has 6 modular optical combination forms which can meet a wide range of applications, and diversified installation methods creates a high cost performance. Flicker free BOKE brand driver and DALI dim available.

- ▶ 50° 50°X100° X20° 110°
- ▶ DALI Flicker Free SLIDE SWITCH 3 in 1
- ▶ AC 220-240V PF_≥0.9 CRI_≥80
- ▶ SAA RoHS CE

Code	Watt	Size(AxBxCmm)	Lumen(±5%)	N.W/pc(kgs)	Q'ty/CTN
DB142A-1200-36W	36W	1155x51x72	3400lm	1.95	6PCS
DB142A-1500-42W	42W	1535x51x72	4100lm	2.38	6PCS
DB142B-1200-36W	36W	1155x51x72	3500lm	2.95	6PCS
DB142B-1500-42W	42W	1535x51x72	4100lm	2.38	6PCS
DB142C-1200-36W	36W	1155x51x72	4700lm	3.95	6PCS
DB142C-1500-42W	42W	1535x51x72	5600lm	2.38	6PCS
DB142D-1200-42W	4x4W+26W	1155x51x180	3700lm	2.06	6PCS
DB142D-1500-50W	4x4W+34W	1535x51x180	4400lm	2.72	6PCS
DB142E-1200-42W	4x4W+26W	1155x51x180	3900lm	2.06	6PCS
DB142E-1500-50W	4x4W+34W	1535x51x180	4400lm	2.72	6PCS
DB142F-1200-24W	24W	1155x51x72	2300lm	1.95	6PCS
DB142F-1500-30W	30W	1535x51x72	2700lm	2.38	6PCS

CCT ——— 3000K 4000K 5000K 5700K

Finish ——— White Black

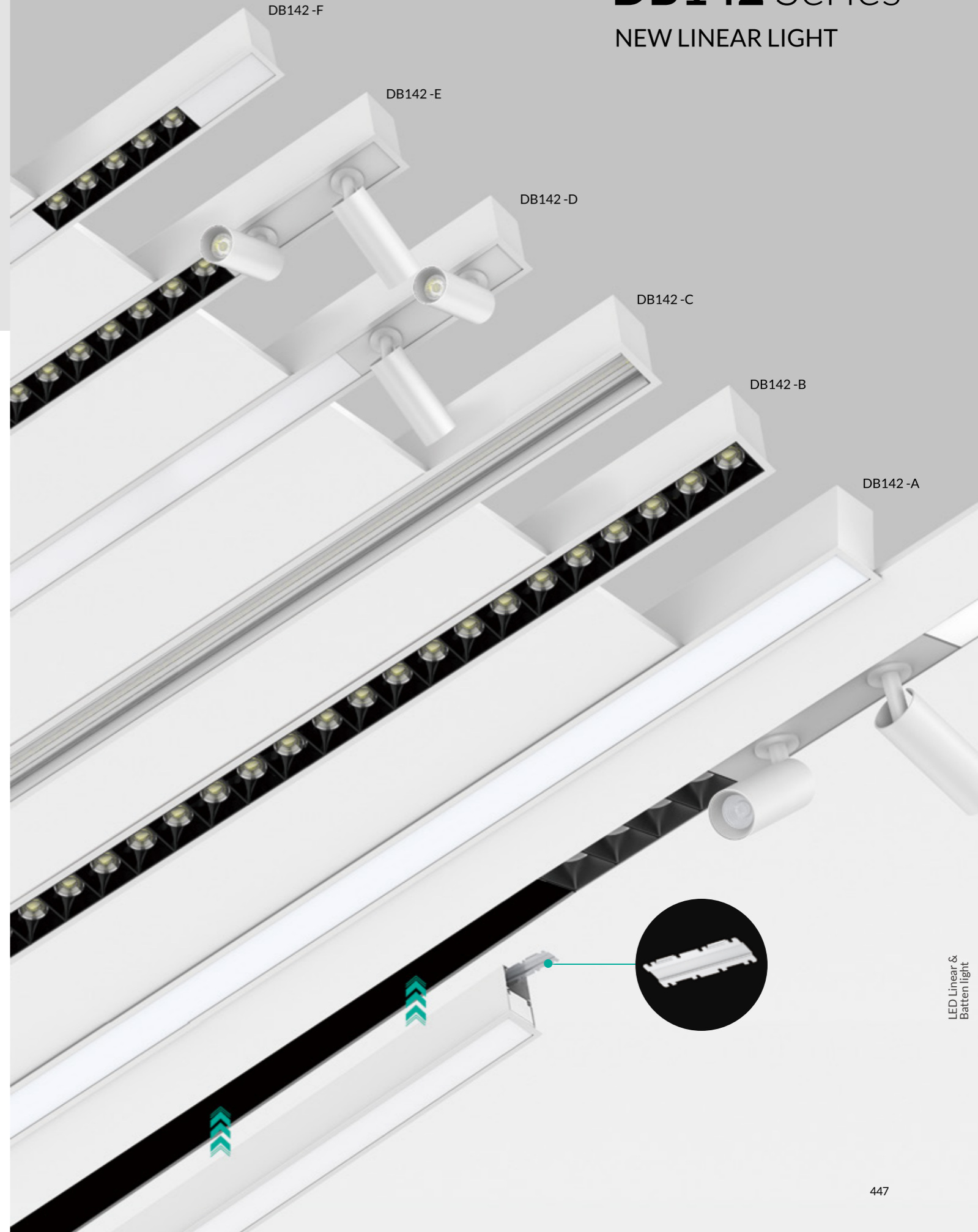

LED Linear & Batten light



DB143 Series

DB143 Linear light

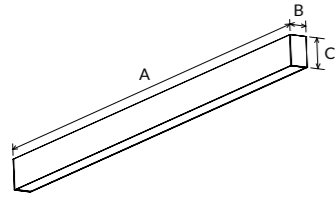

DB143 frameless recessed and surface mounted linear light. Aluminum light housing provides good heat dissipation. It has 6 modular optical combination forms which can meet a wide range of applications, and diversified installation methods creates a high cost performance. Flicker free BOKE brand driver and DALI dim available.

- ▶
- ▶
- ▶
- ▶

Code	Watt	Size(AxBxCmm)	Lumen(±5%)	N.W/pc(kgs)	Q'ty/CTN
DB143A-1200-36W	36W	1147x41x72(without pull switch) 1167x41x72(with pull switch)	3400lm	1.85(without pull switch) 1.87(with pull switch)	6PCS
DB143A-1200-50W	50W	1147x41x72(without pull switch) 1167x41x72(with pull switch)	5200lm	1.85(without pull switch) 1.87(with pull switch)	6PCS
DB143A-1500-42W	42W	1527x41x72(without pull switch) 1547x41x72(with pull switch)	4100lm	2.28(without pull switch) 2.3(with pull switch)	6PCS
DB143A-1500-60W	60W	1527x41x72(without pull switch) 1547x41x72(with pull switch)	6300lm	2.28(without pull switch) 2.3(with pull switch)	6PCS
DB143B-1200-36W	36W	1147x41x72(without pull switch) 1167x41x72(with pull switch)	3500lm	1.85(without pull switch) 1.87(with pull switch)	6PCS
DB143B-1200-50W	50W	1147x41x72(without pull switch) 1167x41x72(with pull switch)	5300lm	1.85(without pull switch) 1.87(with pull switch)	6PCS
DB143B-1500-42W	42W	1527x41x72(without pull switch) 1547x41x72(with pull switch)	4100lm	2.28(without pull switch) 2.3(with pull switch)	6PCS
DB143B-1500-60W	60W	1527x41x72(without pull switch) 1547x41x72(with pull switch)	6400lm	2.28(without pull switch) 2.3(with pull switch)	6PCS
DB143C-1200-36W	36W	1147x41x72(without pull switch) 1167x41x72(with pull switch)	4700lm	1.85(without pull switch) 1.87(with pull switch)	6PCS
DB143C-1200-50W	50W	1147x41x72(without pull switch) 1167x41x72(with pull switch)	6700lm	1.85(without pull switch) 1.87(with pull switch)	6PCS
DB143C-1500-42W	42W	1527x41x72(without pull switch) 1547x41x72(with pull switch)	5600lm	2.28(without pull switch) 2.3(with pull switch)	6PCS
DB143C-1500-60W	60W	1527x41x72(without pull switch) 1547x41x72(with pull switch)	7800lm	2.28(without pull switch) 2.3(with pull switch)	6PCS
DB143D-1200-42W	4x4W+26W	1147x41x72(without pull switch) 1167x41x72(with pull switch)	3700lm	1.96(without pull switch) 1.98(with pull switch)	6PCS
DB143D-1500-50W	4x4W+34W	1527x41x72(without pull switch) 1547x41x72(with pull switch)	4400lm	2.26(without pull switch) 2.64(with pull switch)	6PCS
DB143E-1200-42W	4x4W+26W	1147x41x72(without pull switch) 1167x41x72(with pull switch)	3900lm	1.96(without pull switch) 1.98(with pull switch)	6PCS
DB143E-1500-50W	4x4W+34W	1527x41x72(without pull switch) 1547x41x72(with pull switch)	4400lm	2.26(without pull switch) 2.64(with pull switch)	6PCS
DB143F-1200-24W	24W	1147x41x72(without pull switch) 1167x41x72(with pull switch)	2300lm	1.85(without pull switch) 1.87(with pull switch)	6PCS
DB143F-1500-30W	30W	1527x41x72(without pull switch) 1547x41x72(with pull switch)	2700lm	2.28(without pull switch) 2.3(with pull switch)	6PCS

CCT ——— 3000K 4000K 5000K 5700K Finish ——— White Black

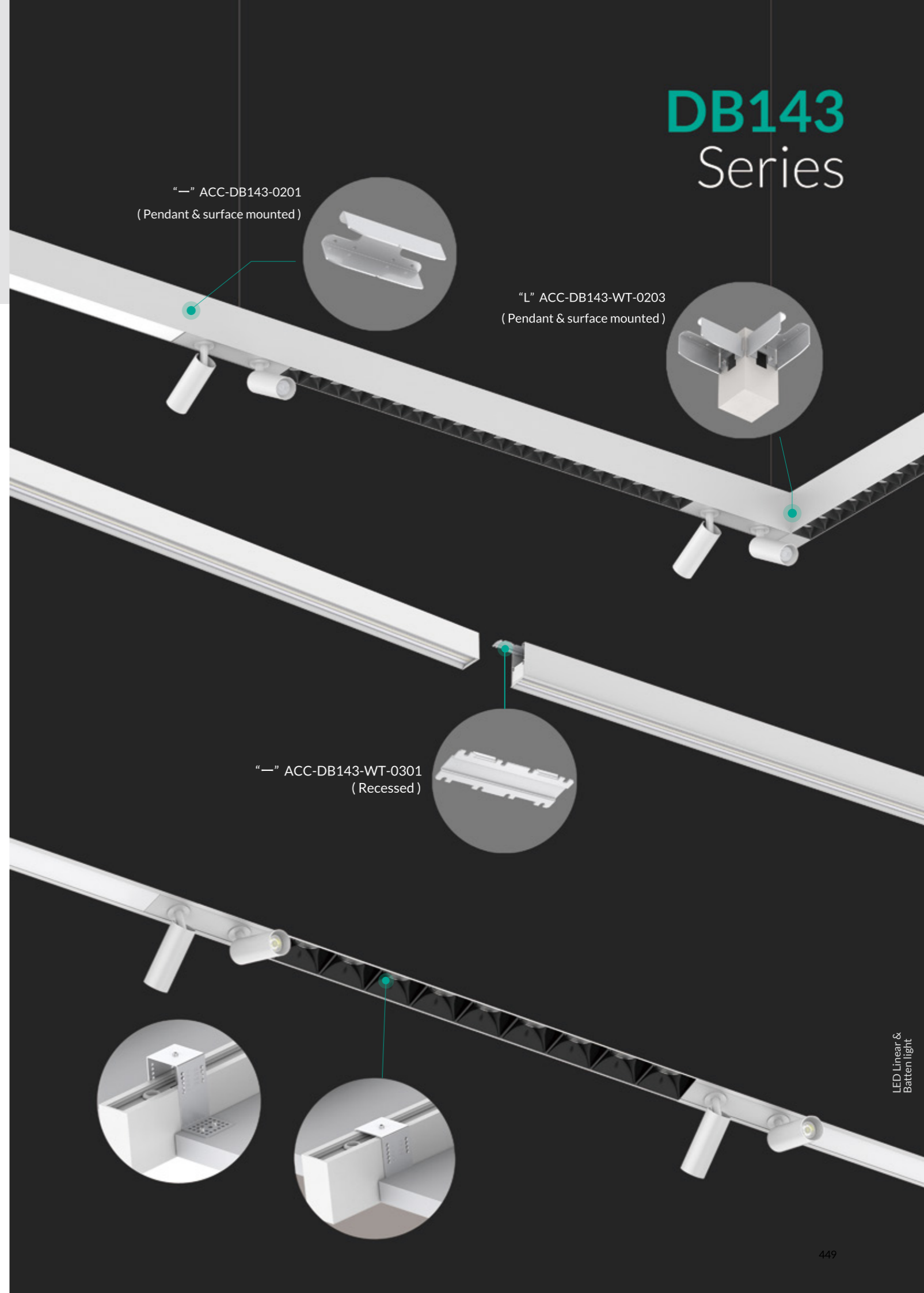

LED Linear & Batten light

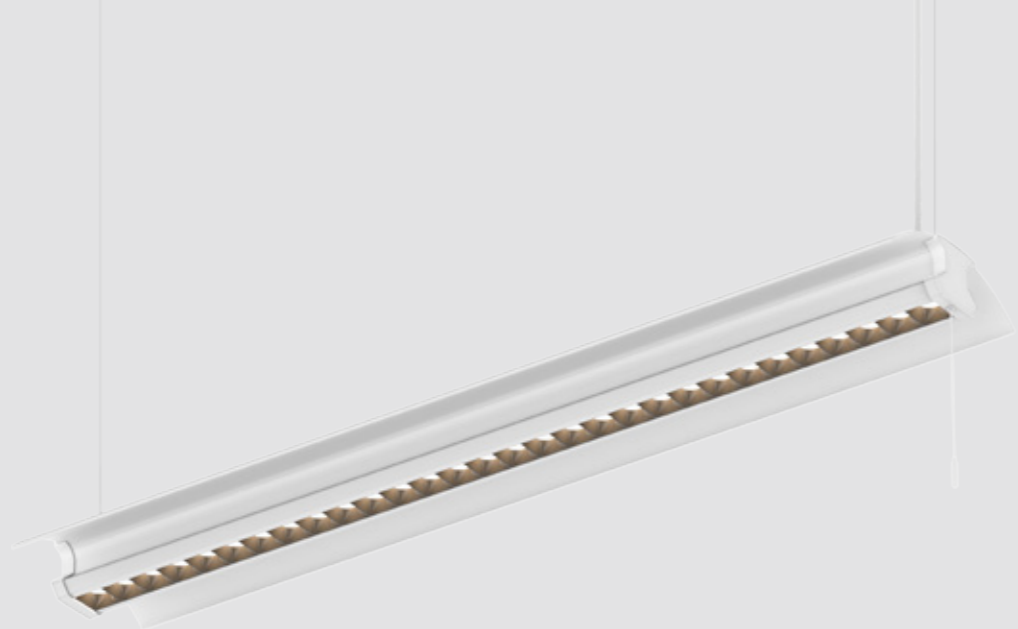

DB147 Linear light

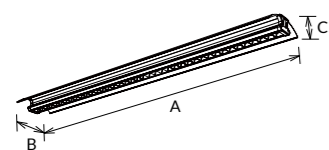

Not only with modern and classic aesthetics looking, DB147 linear light also has a special optic design: up&down lighting and symmetrical lighting(with special wing shape). It adopts high lumen efficiency SMD light source, 1W LED for up&down main lighting, 0.2W LED for Symmetrical soft lighting. The shape design highly increased lighting area, also lowered the glare to make it UGR<19. It is suitable for dining room and office to achieve both lighting effect and decoration effect.

- ▶ 50°
- ▶ 20%
80%
100%
- ▶ IP20
- ▶ Flicker Free
- ▶ SLIDE SWITCH 2 in 1
- ▶ AC 220-240V
- ▶ PF≥0.9
- ▶ CRI≥80
- ▶ SAA
- ▶ RoHS
- ▶ CE

Code	Watt	Size(AxBxCmm)	Lumen(±5%)	N.W/pc(kgs)	Q'ty/CTN
DB147-1200-36W	36W	1172x236x74	4100lm	3.70	2PCS
DB147-1200-45W	45W	1172x236x74	4800lm	3.70	2PCS
DB147-1500-40W	40W	1552x236x74	4100lm	3.70	2PCS
DB147-1500-60W	60W	1552x236x74	5800lm	3.70	2PCS

CCT — 3000K 4000K 5000K 5700K

Finish — White

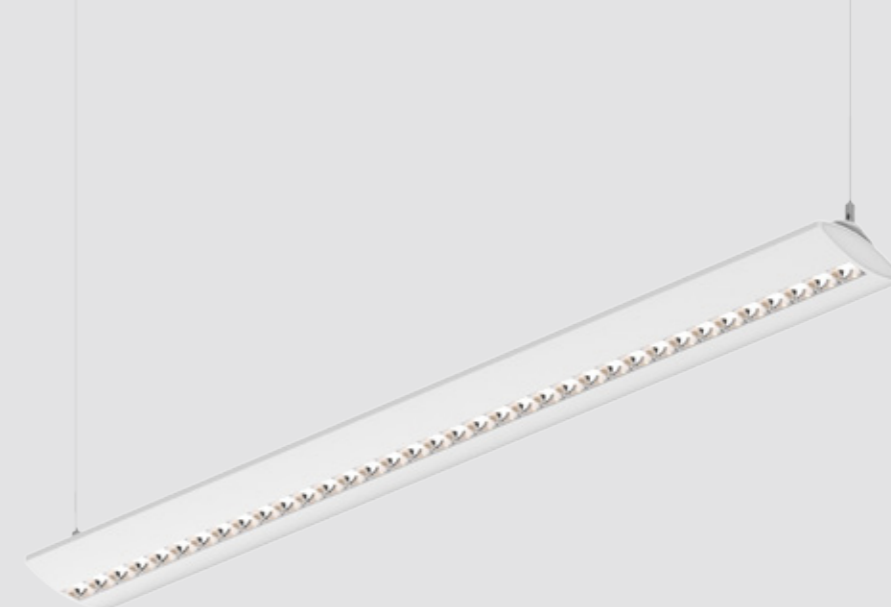

DB155 Linear light

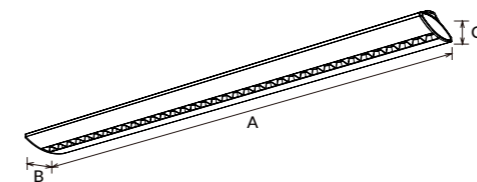

DB155 is a pendant light with curved appearance design. It adopts high lumen SMD light source and bright silver reflector, giving comfortable lighting effect acheive UGR<19. It available with 3CCT, seamless splicing, with up and down lighting deisgn, it's an ideal pendant light for office lighting.

- ▶ 45°
- ▶ UGR<19
- ▶ IP20
- ▶ DALI
- ▶ Flicker Free
- ▶ SLIDE SWITCH 3 in 1
- ▶ AC 200-264V
- ▶ PF≥0.9
- ▶ CRI≥80
- ▶ SAA
- ▶ RoHS
- ▶ CE

Code	Watt	Size(AxBxCmm)	Lumen(±5%)	N.W/pc(kgs)	Q'ty/CTN
DB155-1200-36W	9W(Indirect)+27W(Direct)	1161.5x150x40	3700lm	2.70	6PCS
DB155-1200-50W	12.5W(Indirect)+37.5W(Direct)	1161.5x150x40	4800lm	2.70	6PCS
DB155-1500-40W	10W(Indirect)+30W(Direct)	1143.5x150x40	4000lm	3.25	6PCS
DB155-1500-60W	15W(Indirect)+45W(Direct)	1143.5x150x40	5800lm	3.25	6PCS

CCT — 3000K 4000K 5000K 5700K

Finish — White Black

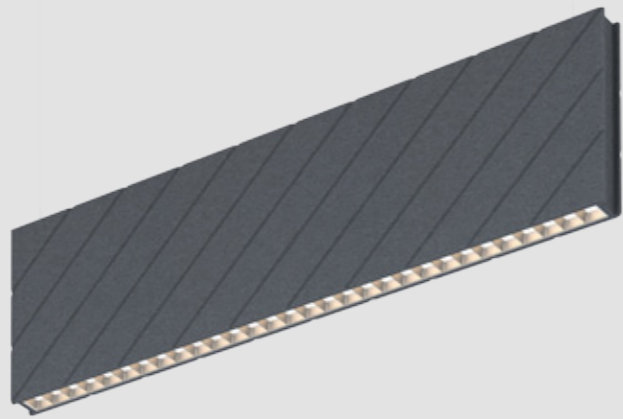

DB160 Acoustic linear light

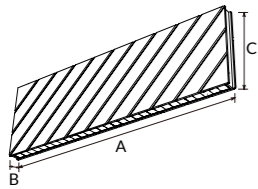

DB160 is an integrated acoustic linear system that offers unmatched possibilities to control noise and provide optimal lighting in commercial environments. For optic design, DB160 adopts high lumen SMD, direct and indirect lighting design, offering a uniform light distribution. For sound management, the polyester fiber sound-absorbing board is with striped grooves, and the concave-convex structure can fully diffuse excess sound rays, which can realize frequency sound absorption and diffusion, making the sound clearer and fuller, better integration of acoustics and modern lamps together. It supports CCT adjustable and DALI dim.

- ▶
- ▶
- ▶
- ▶
- ▶

Code	Watt	Size(AxBxCmm)	Lumen(±5%)	N.W/pc(kgs)	Q'ty/CTN
DB160A-1200-46W/ACC-DB160	36W(Direct)	1292x64x400	3800lm	5.28	1PCS
DB160A-1200-46W/ACC-DB160	10W(Indirect)+36W(Direct)	1292x64x400	5000lm	5.28	1PCS
DB160A-1500-65W/ACC-DB160	50W(Direct)	1500x64x400	5000lm	5.95	1PCS
DB160A-1500-65W/ACC-DB160	15W(Indirect)+50W(Direct)	1500x64x400	6800lm	5.95	1PCS
DB160B-1200-46W/ACC-DB160	36W(Direct)	1292x64x400	4550lm	5.28	1PCS
DB160B-1200-46W/ACC-DB160	10W(Indirect)+36W(Direct)	1292x64x400	5750lm	5.28	1PCS
DB160B-1500-65W/ACC-DB160	50W(Direct)	1500x64x400	6200lm	5.95	1PCS
DB160B-1500-65W/ACC-DB160	15W(Indirect)+50W(Direct)	1500x64x400	8000lm	5.95	1PCS
DB160C-1200-46W/ACC-DB160	36W(Direct)	1292x64x400	3800lm	5.28	1PCS
DB160C-1200-46W/ACC-DB160	10W(Indirect)+36W(Direct)	1292x64x400	4800lm	5.28	1PCS
DB160C-1500-65W/ACC-DB160	50W(Direct)	1500x64x400	5800lm	5.95	1PCS
DB160C-1500-65W/ACC-DB160	15W(Indirect)+50W(Direct)	1500x64x400	7500lm	5.95	1PCS
ACC-DB160-1200	-	853x17.3x7	-	0.135	24PCS
ACC-DB160-100	-	1061x17.3x7	-	0.16	24PCS
ACC-DB160-(DA/D0)-BK(WT)-0200	-	Ø100x25	-	0.28	4PCS

CCT ——— 3000K 4000K 5000K 5700K Finish ——— White Black

Installation accessories ——— Acoustic lighting fixture DB160/ACC-DB160 Upward LED module ACC-DB160-1200/1500 Round ceiling plate ACC-DB160-(DA/D0)-BK(WT)-0200

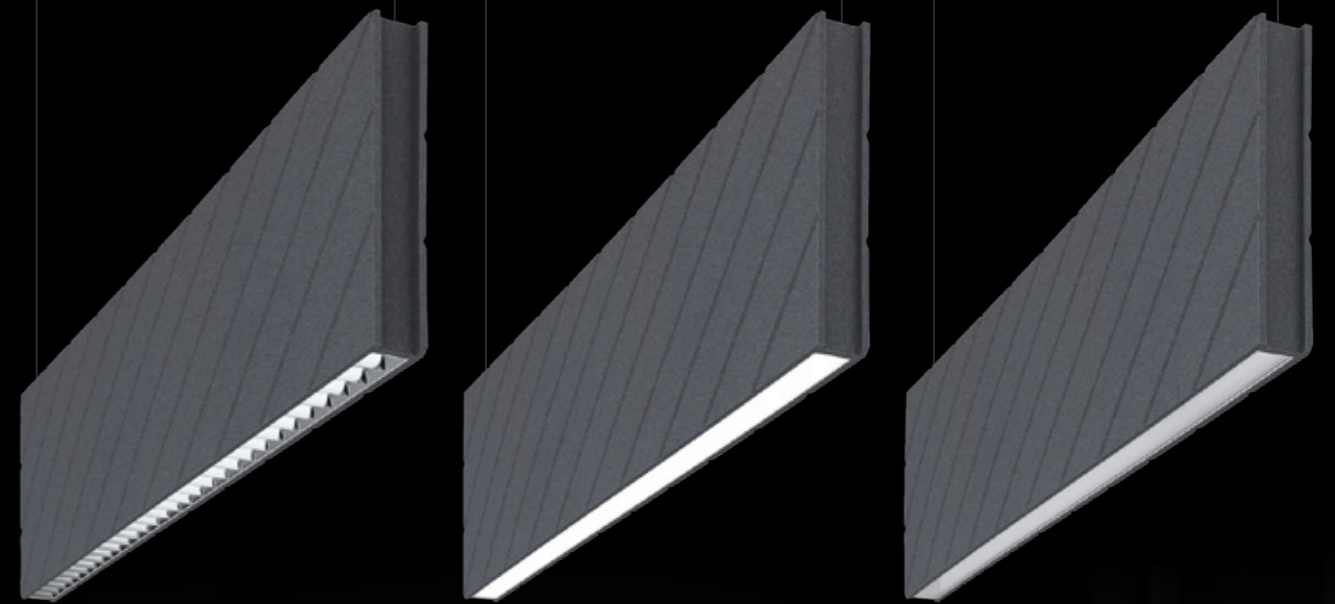

DB160A

Grill reflector
UGR<19 95lm/w @White 4000K

DB160B

Opal diffuser
120lm/w @White 4000K

DB160C

Prismatic diffuser
95lm/w @White 4000K

Acoustic Lighting LED Linear DB160



CCT switch & Up module switch



LED Linear & Batten light

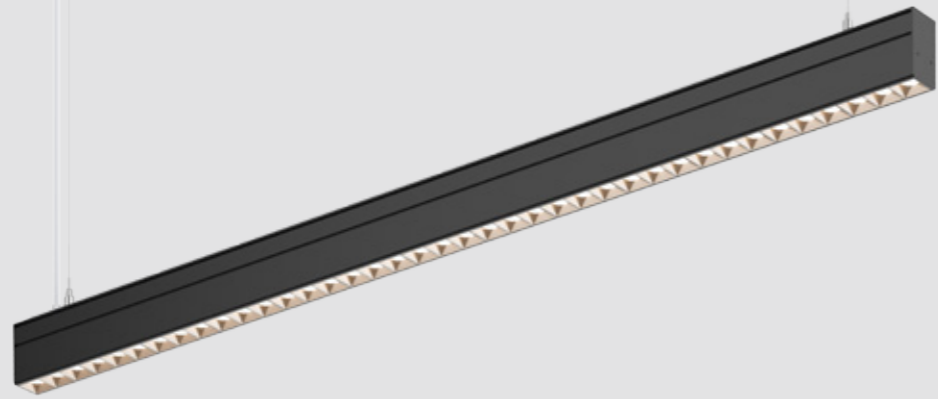

DB165 Linear light

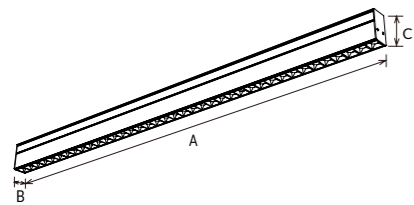

DB165 linear light is anti-glare optic design with multiple beam angles, offering various light distribution options. It adopts internal driver, aluminium housing, and high lumen SMD, also supports seamless splicing and DALI dim.

- ▶ 15° 24° 38° 50° 35°x55° IP20
- ▶ Flicker Free
- ▶ AC 200-264V PF≥0.9 CRI≥80
- ▶ SAA RoHS CE

Code	Watt	Size(AxBxCmm)	Lumen(±5%)	N.W/pc(kgs)	Q'ty/CTN
DB165-1200-42W	42W	1180x40x75	4100lm	2.06	6PCS
ACC-DB165-1200-42W	42W	1226x40x75	4100lm	1.84	6PCS

CCT 3000K 4000K 5000K 5700K

Finish White Black

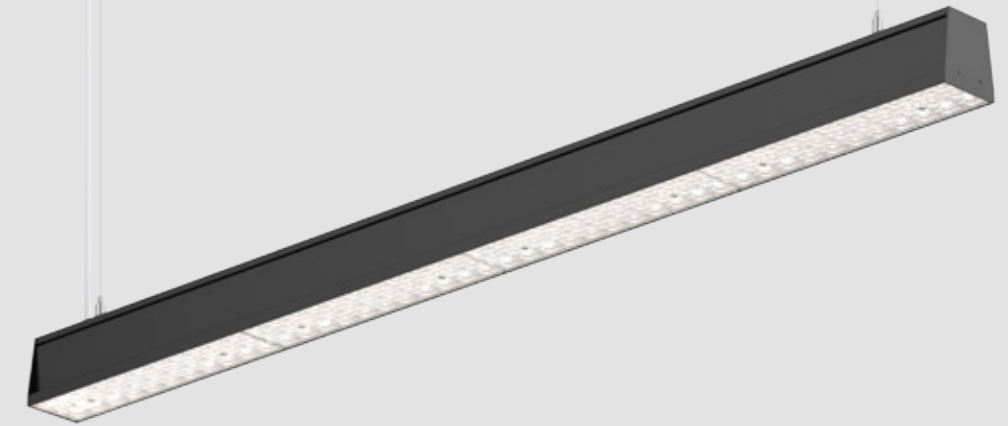

DB166 Linear light

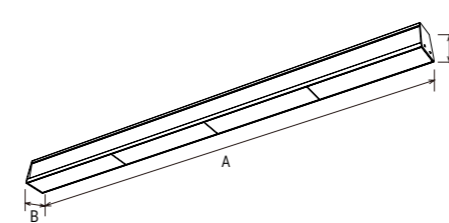

DB166 linear light is 120lm/W high lumen design to achieve energy saving conception. It has multiple beam angles, offering various light distribution options. It adopts internal driver, aluminium housing, and high lumen SMD, also supports seamless splicing and DALI dim.

- ▶ 30° 60° 90° Symmetric distribution 2x IP20
- ▶ Flicker Free
- ▶ AC 200-264V PF≥0.9 CRI≥80
- ▶ SAA RoHS CE

Code	Watt	Size(AxBxCmm)	Lumen(±5%)	N.W/pc(kgs)	Q'ty/CTN
DB166-1200-40W	40W	1152x66x73	5000lm	2.73	6PCS
ACC-DB166-1200-40W	40W	1198x66x73	5000lm	2.45	6PCS
DB166-1200-60W	60W	1152x66x73	7000lm	2.73	6PCS
ACC-DB166-1200-60W	60W	1198x66x73	7000lm	2.45	6PCS

CCT 3000K 4000K 5000K 5700K

Finish White Black



DB151 Linear light

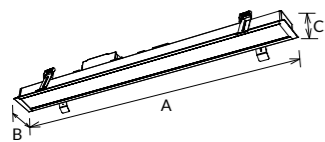

DB151 series LED Batten Light is a functional recessed batten light which could do different length customization, no limitation for splicing quantity. Special structure design with different covers, splicing shapes, recessed ways. Recessed with N-shape, T-shape and H-shape accessories as per installation demands. Interchangeable CCT with slide switch. Support non-dim and DALI dimming. DB151A with PC/prismatic diffusers, six kinds of connectors for choice. DB151B with grille design, DB151C with lens design, both of their straight splicing with magnetic end cap.

- ▶ 60° 90° 110° 36°x20° IP40
- ▶ DALI Flicker Free
- ▶ AC 220-240V PF≥0.9 CRI≥80
- ▶ SAA RoHS CE

Code	Watt	Size(AxBxCmm)	Cut-out(±5mm)	Lumen(±5%)	N.W/pc(kgs)	Q'ty/CTN
DB151A/B-600-15W	15W	615x62x29	607x54	1600lm	0.67/0.71	12PCS
DB151A/B-1200-30W	30W	1208x62x29	1201x54	3400lm/3200lm	1.21/1.26	6PCS
DB151A/B-1500-37.5W	37.5W	1505x62x29	1498x54	4200lm	1.48/1.54	6PCS
DB151A/B-1800-45W	45W	1802x62x29	1794x54	5000lm	1.78/1.85	6PCS
DB151A/B-2400-60W	60W	2395x62x29	2388x54	6600lm/6200lm	2.27/2.36	6PCS
DB151C-600-15W	15W	615x62x29	607x54	1600lm	0.75	12PCS
DB151C-1200-30W	30W	1208x62x29	1201x54	3200lm	1.37	6PCS
DB151C-1500-37.5W	37.5W	1505x62x29	1498x54	4200lm	1.69	6PCS
DB151C-1800-45W	45W	1802x62x29	1794x54	5000lm	2.02	6PCS
DB151C-2400-60W	60W	2395x62x29	2388x54	6200lm	2.62	6PCS

CCT ——— 3000K 4000K 5000K 5700K

Finish ——— White Black

Installation accessories

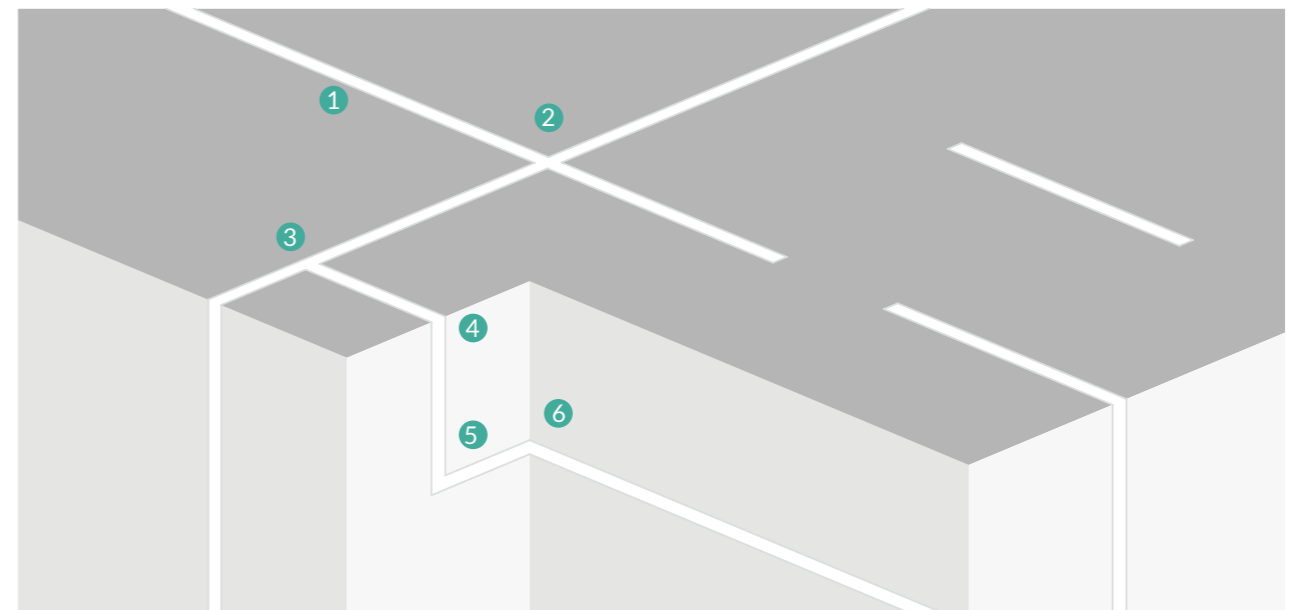
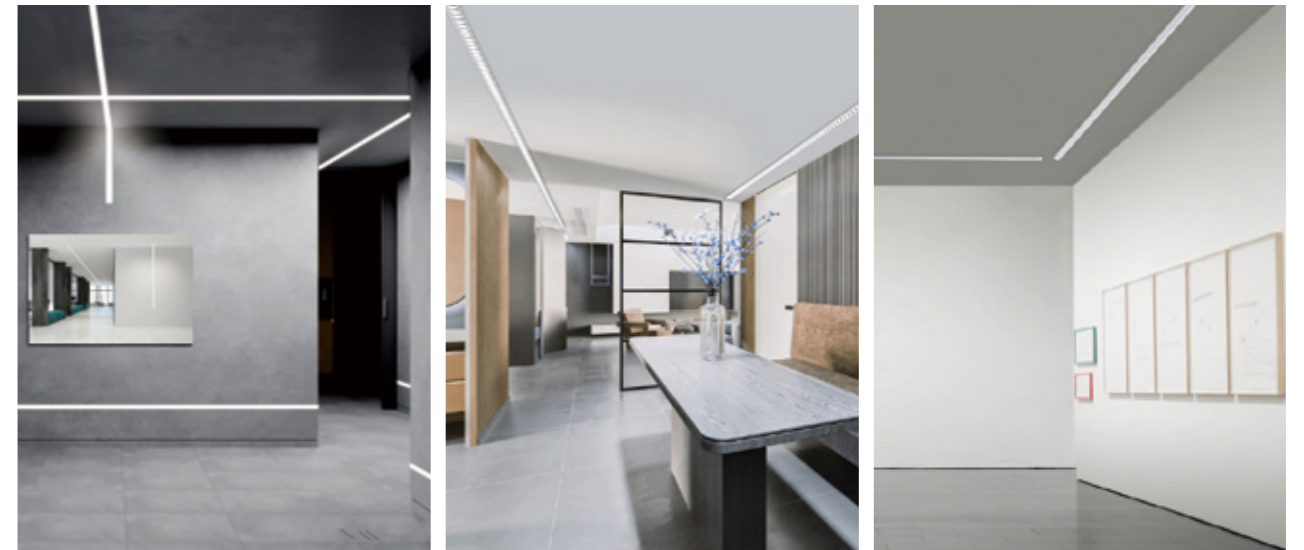
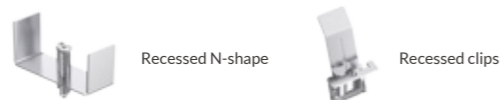



DB181 NEW Linear light

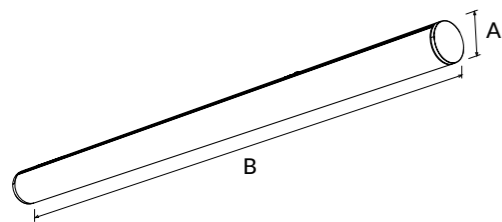

DB181 is a round batten with multiple function design, 3CCT, DALI/1-10V/triac dim, emergency, sensor, etc. It supports surface mount/pendant installation way.

- ▶ 110° IP40
- ▶ DIM DALI 0-10V Flicker Free
- ▶ Emergency
- ▶ AC 200-240V PF ≥ 0.9 CRI ≥ 80
- ▶ SAA RoHS CE

Code	Watt	Size(AxBmm)	Lumen(±5%)	N.W/pc(kgs)	Q'ty/CTN
DB181-600-20W	20W	Ø72x600	2500lm	0.95	12PCS
DB181-1200-40W	40W	Ø72x1200	5000lm	1.90	6PCS
DB181-1800-60W	60W	Ø72x1800	7500lm	2.85	4PCS

CCT — 3000K 4000K 5000K 5700K Finish — White Black

Installation accessories — Suspension kit ACC-DB181 Splicing accessories

DB05 Batten

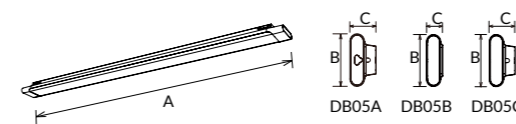

Elegant design, low cost, super slim construction and superior capability, aluminum profile body for good thermal dissipate. Easy installation provided with surface mounted and suspended.

- ▶ 120° IP20
- ▶ DIM Flicker Free
- ▶ AC 100-240V AC 200-240V PF ≥ 0.9 CRI ≥ 80
- ▶ SAA RoHS CE

Code	Watt	Size(AxBxCmm)	Lumen(±5%)	N.W/pc(kgs)	Q'ty/CTN
DB05A/C-600-20W	20W	600X90X46	1710lm	0.86	12PCS
DB05A/C-900-30W	30W	900X90X46	2630lm	1.30	12PCS
DB05A/C-1200-40W	40W	1200X90X46	3540lm	1.98	12PCS
DB05B-600-20W	20W	600X90X28	1710lm	0.82	20PCS
DB05B-900-30W	30W	900X90X28	2630lm	0.95	12PCS
DB05B-1200-40W	40W	1200X90X28	3540lm	1.50	12PCS

CCT — 3000K 4000K 5000K 5700K Finish — White Black

Installation accessories — Suspension kit ACC-DB05B-0200 Surface mounted kit ACC-DB05B-0100

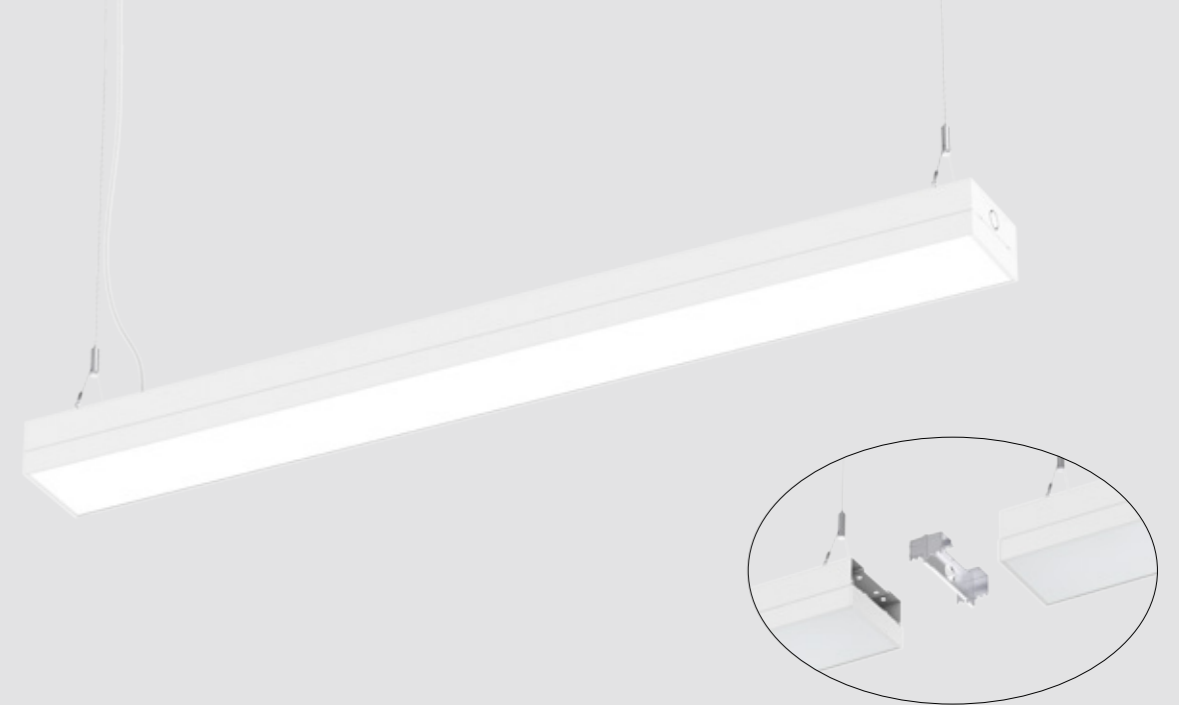
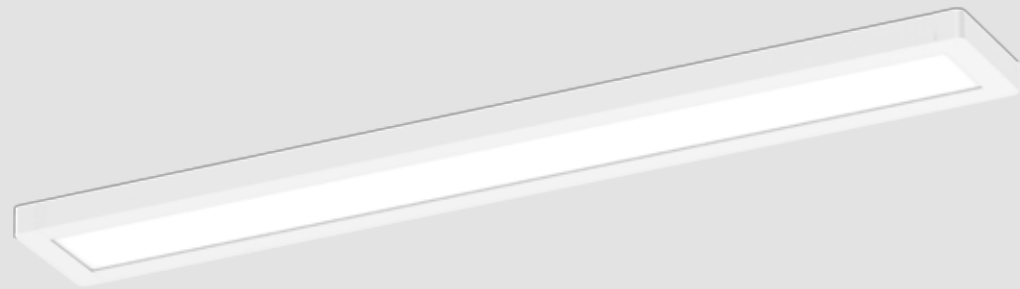

DB179 NEW Batten

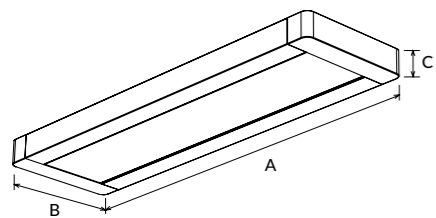

DB179 is a slim batten light with big lighting area, available with single and 3CCT, triac dim, DALI dim function, high lumen efficiency 120lm/W. Available with surface and suspension installation.

- ▶ 110° IP20
- ▶ DIM DALI Flicker Free SLIDE SWITCH 3 in 1
- ▶ AC 200-240V PF≥0.9 CRI≥80
- ▶ SAA RoHS CE

Code	Watt	Size(AxBxCmm)	Lumen(±5%)	N.W/pc(kgs)	Q'ty/CTN
DB179-550-20W	20W	550x160x35	2500lm	0.94	12PCS
DB179-850-30W	30W	850x160x35	4000lm	1.37	6PCS
DB179-1150-40W	40W	1150x160x35	5300lm	1.82	6PCS
DB179-1450-50W	50W	1450x160x35	6500lm	2.16	4PCS

CCT 3000K 4000K 5000K 5700K

Finish White Black

Installation accessories Suspension kit

DB105A Batten

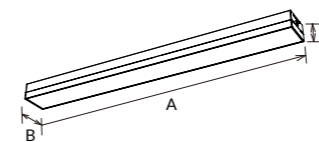

DB105A is a newly seamless splicing batten design, which adopts high lumen SMD reaching 120lm/W, prism lamp shade to offer a uniform light output and flicker free driver inside. Interchangeable CCT with slide switch is available. Surface mounted, pendant and splicing installation for options.

- ▶ 100° IP20
- ▶ Flicker Free SLIDE SWITCH 3 in 1
- ▶ AC 220-240V PF≥0.9 CRI≥80
- ▶ SAA RoHS CE

Code	Watt	Size(AxBxCmm)	Lumen(±5%)	N.W/pc(kgs)	Q'ty/CTN
DB105A-600-24W-C3 Surface mount	24W	600×120×70	3000lm	1.26	12PCS
DB105A-1200-38W-C3 Surface mount	38W	1200×120×70	5000lm	2.35	6PCS
DB105A-1500-55W-C3 Surface mount	55W	1500×120×70	7000lm	2.88	4PCS
DB105A-600-24W-C3 Pendant	24W	600×120×70	3000lm	1.38	12PCS
DB105A-1200-38W-C3 Pendant	38W	1200×120×70	5000lm	2.47	6PCS
DB105A-1500-55W-C3 Pendant	55W	1500×120×70	7000lm	3.00	4PCS

CCT 3000K 4000K 5700K

Finish White Black

Installation accessories Suspension kit

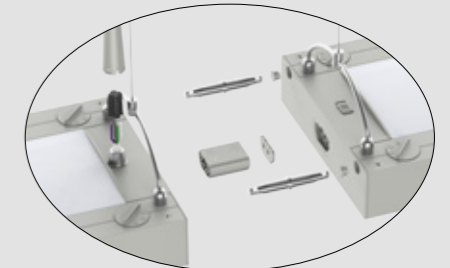
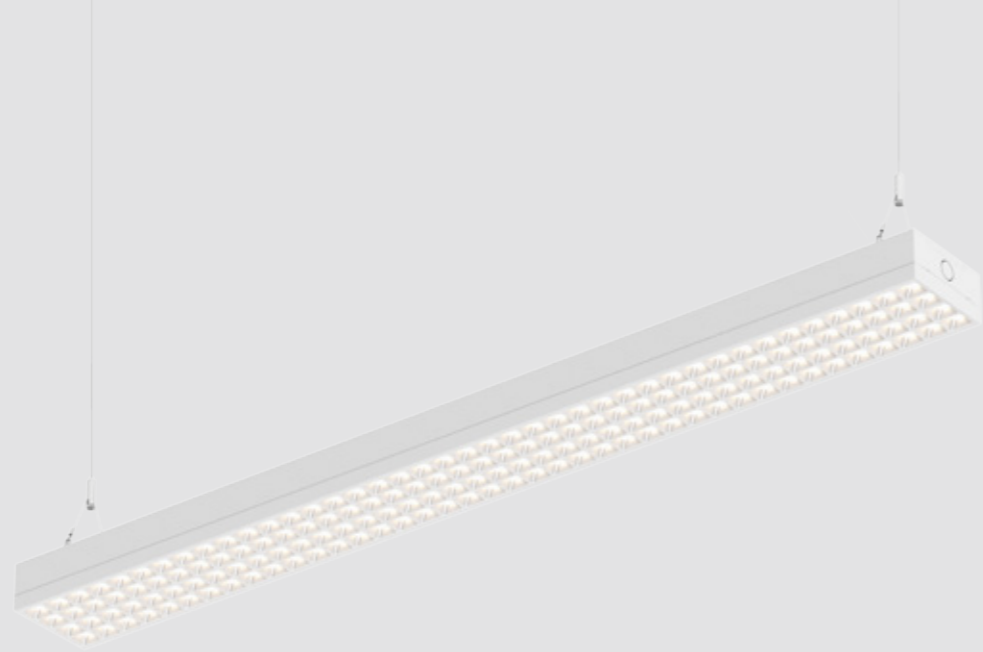

Patent

DB157 Batten

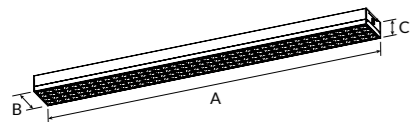

DB157 grill batten light is a low glare and seamless splicing design, which adopts internal flicker free driver, aluminium housing, also high lumen SMD. It is screwless and quick buckle assembly design for easy and convenient installation, and supports CCT adjustable, power adjustable.

- ▶ UGR<19
- ▶ Flicker Free, 3-in-1 Slide Switch, Adjustable Power
- ▶ AC 200-240V, PF≥0.9, CRI≥80, CRI≥90
- ▶ SAA, RoHS, CE

Code	Watt	Size(AxBxCmm)	Lumen(±5%)	N.W/pc(kgs)	Q'ty/CTN
DB157-1200-40W-A4C2	40W/35W/30W/25W	1200X120X59	3200-5400lm	2.92	6PCS
DB157-1200-40W-A4C2 Pendant	40W/35W/30W/25W	1200X120X59	3200-5400lm	3.03	6PCS
DB157-1500-50W-A4C2	50W/45W/40W/35W	1500X120X59	4600-6600lm	3.52	4PCS
DB157-1500-50W-A4C2 Pendant	50W/45W/40W/35W	1500X120X59	4600-6600lm	3.62	4PCS

CCT ——— 3000K 4000K 5000K 5700K

Finish ——— White Black

Installation accessories



DB104A Linear light

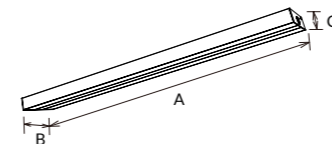

This linear fixture is a splicing design. Adopt high lumen SMD LED light source and high light transmittance PC cover. Easy installation and maintenance with high cost performance, 1200mm and 1500mm size optional. UGR<19 with low glare. Function: CCT Changeable, DALI dimmable.

- ▶ UGR<19
- ▶ DALI, Flicker Free, 3-in-1 Slide Switch
- ▶ AC 200-240V, PF≥0.9, CRI≥80
- ▶ SAA, RoHS, CE

Code	Watt	Size(AxBxCmm)	Lumen(±5%)	N.W/pc(kgs)	Q'ty/CTN
DB104A-1200-40W-DA	40W	1200x200x50	4600lm	4.91	4PCS
DB104A-1200-40W-DAP2	40W	1200x200x50	4600lm	4.91	4PCS
DB104A-1500-55W-DA	55W	1500x200x50	6300lm	5.79	2PCS
DB104A-1500-55W-DAP2	55W	1500x200x50	6300lm	5.79	2PCS

CCT ——— 3000K 4000K 5700K

Finish ——— Gray



DB08 Batten

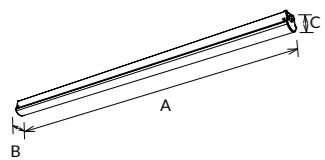

The design of DB08 batten realizes low cost, simple construction and superior capability, milky PC diffuser achieves anti-glare and high light transmittance. It is a high efficient and low cost product with quite large potential market.

- ▶
- ▶
- ▶

Code	Watt	Size(AxBxCmm)	Lumen(±5%)	N.W/pc(kgs)	Q'ty/CTN
DB08-600-20W	20W	625X58.5X58.5	2060lm	0.78	10PCS
DB08-1200-40W	40W	1225X58.5X58.5	3960lm	1.50	10PCS
DB08-1500-45W	45W	1525X58.5X58.5	4860lm	1.90	6PCS

CCT — 3000K 4000K 5000K 5700K

Installation accessories — Suspension kit

Finish — White Black



DB138 Batten

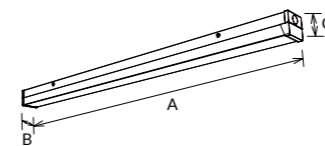

DB138 LED batten light is a perfect replacement for traditional tube or high cost tri-proof light. Adopts high lumen SMD LED and high light transmittance PC shade. It realizes simple disassembly with 4 fast buttons, easier installation and maintenance with high cost performance. Besides, it has 600mm, 1200mm, 1500mm size optional, interchangeable CCT or power by slide switch. Microwave sensor, emergency functions for more application area demand.

- ▶
- ▶
- ▶

Code	Watt	Size(AxBxCmm)	Lumen(±5%)	N.W/pc(kgs)	Q'ty/CTN
DB138-600-20W-A2	20W	603x65x66	10W:1300lm/20W:2600lm	0.88	6PCS
DB138-1200-40W-A2	40W	1203x65x66	20W:2600lm/40W:4600lm	1.37	6PCS
DB138-1500-60W-A2	60W	1503x65x66	35W:4300lm/60W:6500lm	1.71	6PCS
DB138-1200-40W-EA2	40W	1203x65x66	20W:2500lm/40W:4500lm	1.37	6PCS
DB138-1500-60W-EA2	60W	1503x65x66	35W:4200lm/60W:6500lm	1.71	6PCS
DB138-600-20W-S7	20W	603x65x66	2500lm	0.88	6PCS
DB138-1200-40W-S7	40W	1203x65x66	4500lm	1.37	6PCS
DB138-1500-60W-S7	60W	1503x65x66	6500lm	1.71	6PCS

CCT — 3000K 4000K 5700K

Installation accessories — Suspension kit

Finish — White



DB186 NEW Batten

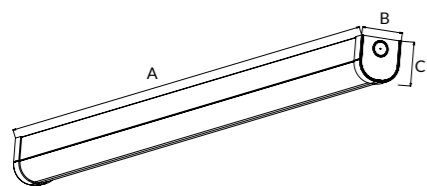

DB186 LED modular design with simple disassemble, Full size: 600mm/1200mm/1800mm. It adopts SMD high lumen efficiency 140lm/W and 180lm/W for options. Multiple functions: interchangeable CCT/PIR sensor/emergency/DALI dim and loop in/out are available. Easy installation and maintenance, widely installation way: surface mounted/suspended.

- ▶ IP40 IK06 IK10
- ▶
- ▶
- ▶

Code	Watt	Size(AxBxCmm)	Lumen(±5%)	N.W/pc(kgs)	Q'ty/CTN
DB186A-600-10W(ECO)	10W	600x65x66	1450lm	0.65	12PCS
DB186A-600-20W(ECO)	20W	600x65x66	2850lm	0.65	12PCS
DB186A-1200-20W(ECO)	20W	1200x65x66	2850lm	1.28	12PCS
DB186A-1200-38W(ECO)	38W	1200x65x66	5400lm	1.28	12PCS
DB186A-1500-30W(ECO)	30W	1500x65x66	4300lm	1.56	12PCS
DB186A-1500-50W(ECO)	50W	1500x65x66	7400lm	1.56	12PCS
DB186A-1800-30W(ECO)	30W	1800x65x66	4300lm	2.16	6PCS
DB186A-1800-50W(ECO)	50W	1800x65x66	7400lm	2.16	6PCS
DB186A-600-20W(STD)	20W/18W/15W/10W	600x65x66	2850lm	0.65	12PCS
DB186A-1200-40W(STD)	40W/35W/30W/20W	1200x65x66	5700lm	1.28	12PCS
DB186A-1500-50W(STD)	50W/40W/32W/25W	1500x65x66	7100lm	1.56	12PCS
DB186A-1800-60W(STD)	60W/50W/40W/30W	1800x65x66	8500lm	2.16	6PCS
DB186A-600-18W(PRO)	18W/15W/13W/9W	600x65x66	3250lm	0.65	12PCS
DB186A-1200-30W(PRO)	30W/25W/20W/15W	1200x65x66	5450lm	1.28	12PCS
DB186A-1500-38W(PRO)	38W/33W/28W/29W	1500x65x66	6900lm	1.56	12PCS
DB186A-1800-48W(PRO)	48W/40W/32W/24W	1800x65x66	8700lm	2.16	6PCS

CCT 3000K 4000K 5000K 5700K

Finish White

Installation accessories Suspension kit ACC-DB121-0201



PIR Sensor



Interchangeable CCT with slide switch



3000K



4000K



5700K

SIMPLE **MODULAR** DESIGN
WITH HIGH LUMEN **140/180 LM/W**



DB121 Batten

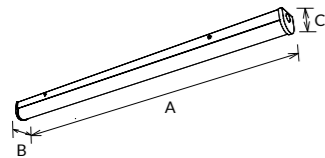

DB121 batten light realizes simple disassemble with 4 fast buttons, 600mm/1200mm/1500mm/1800mm size as option. Adopts SMD high lumen efficiency 120lm/W and high light transmittance PC shade. It has multiple functions: interchangeable CCT/ microwave sensor/emergency/splicing design, 1-10V dim, DALI dim. Loop in/out and fast connector design for easier wire connection; easy installation and maintenance, widely installation way: surface mounted/suspended/splicing available.

- ▶
- ▶
- ▶
- ▶

Code	Watt	Size(AxBxCmm)	Lumen(±5%)	N.W/pc(kgs)	Q'ty/CTN
DB121A-600-17W	17W	603x65x66	2200lm	0.88	6PCS
DB121A-1200-22W	22W	1203x65x66	2900lm	1.37	6PCS
DB121A-1200-38W	38W	1203x65x66	5000lm	1.37	6PCS
DB121A-1500-35W	35W	1503x65x66	4600lm	1.71	6PCS
DB121A-1500-58W	58W	1503x65x66	7600lm	1.71	6PCS
DB121A-1800-55W	55W	1803x65x66	7200lm	2.13	6PCS
DB121A-1800-70W	70W	1803x65x66	9000lm	2.13	6PCS
DB121B-600-17W	17W	603x65x66	2200lm	0.88	6PCS
DB121B-1200-22W	22W	1203x65x66	2900lm	1.37	6PCS
DB121B-1200-38W	38W	1203x65x66	5000lm	1.37	6PCS
DB121B-1500-35W	35W	1503x65x66	4600lm	1.71	6PCS
DB121B-1500-58W	58W	1503x65x66	7600lm	1.71	6PCS
DB121B-1800-55W	55W	1803x65x66	7200lm	2.13	6PCS
DB121B-1800-70W	70W	1803x65x66	9000lm	2.13	6PCS

CCT ——— 3000K 4000K 5000K 5700K

Finish ——— White

Installation accessories ——— Suspension kit ACC-DB121-0201

SIMPLE DISASSEMBLE MODULAR DESIGN LED BATTEN SERIES DB121



Fast connector

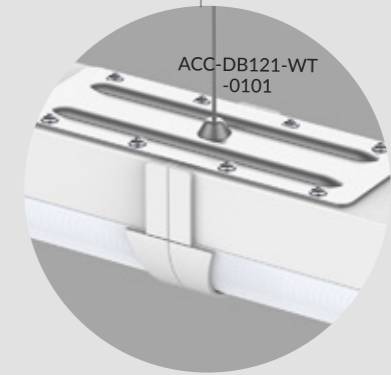

Suspension kit for linkable



DB76 Batten

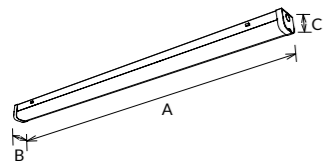

The iron lamp body provides excellent heat dissipation. It is made of high lumen 2835 SMD led chips, energy saving, instant start. New plastic snap-on button design for easy installation.

- ▶ 120° IP20
- ▶ Flicker Free SLIDE SWITCH 3 in 1 PIR Sensor Zigbee Smart Lighting
- ▶ AC 220-240V PF≥0.9 CRI≥80
- ▶ SAA RoHS CE

Code	Watt	Size(AxBxCmm)	Lumen(±5%)	N.W/pc(kgs)	Q'ty/CTN
DB76-600-20W	20W	603X71X64	2200lm	7.8	12PCS
DB76-1200-40W	40W	1203X71X64	4600lm	15.4	12PCS
DB76-1500-50W	50W	1503X71X64	6000lm	18.7	12PCS
DB76-1500-58W	58W	1503X71X64	6500lm	18.7	12PCS
DB76-1800-58W	50W	1803X71X64	7000lm	13.2	6PCS
DB76-1800-72W	72W	1803X71X64	8350lm	13.2	6PCS

CCT ——— 3000K 4000K 5000K 5700K

Finish ——— White Black

Installation accessories ——— Suspension kit

DB144 Batten

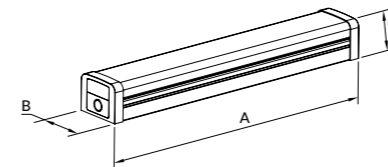

DB144 batten light is a simple disassemble and easy installation with a snap-joint design. It adopts internal flicker free driver,high lumen SMD and high light transmittance PC shade, offering a uniform light output, and supports CCT adjustable.

- ▶ 120° IP20 IK06
- ▶ Flicker Free SLIDE SWITCH 3 in 1
- ▶ AC 200-240V PF≥0.9 CRI≥80
- ▶ SAA RoHS CE

Code	Watt	Size(AxBxCmm)	Lumen(±5%)	N.W/pc(kgs)	Q'ty/CTN
DB144-600-20W-C3	20W	600X83X68	2300lm	0.91	6PCS
DB144-1200-40W-C3	40W	1200X83X68	4600lm	1.70	6PCS

CCT ——— 3000K 4000K 5000K 5700K

Finish ——— White Black



SUPER SLIM BATTEN

DB49 Batten

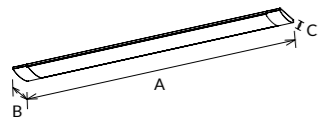

Full size slim batten DB49 featuring uniform light and excellent heat dissipation, CCT changeable by adjusting the slide switch. Easier installation without installing bracket.

- ▶ 120° IP20
- ▶ SLIDE SWITCH 3 in 1 Flicker Free
- ▶ AC 200-240V PF≥0.9 CRI≥80
- ▶ SAA RoHS CE

Code	Watt	Size(AxBxCmm)	Lumen(±5%)	N.W/pc(kgs)	Q'ty/CTN
DB49A-600-20W	20W	600X80X34	2300lm	0.60	10PCS
DB49A-900-30W	30W	900X80X34	3500lm	0.86	10PCS
DB49A-1200-35W	35W	1200X80X34	3950lm	1.12	10PCS
DB49A-1500-40W	40W	1500X80X34	4500lm	1.40	6PCS
DB49B-600-25W	25W	600X124X42	2950lm	0.84	10PCS
DB49B-900-35W	35W	900X124X42	4300lm	1.25	10PCS
DB49B-1200-45W	45W	1200X124X42	5600lm	1.67	10PCS
DB49B-1500-50W	50W	1500X124X42	5650lm	2.00	6PCS

CCT ——— 3000K 4000K 5000K 5700K

Finish ——— White Black

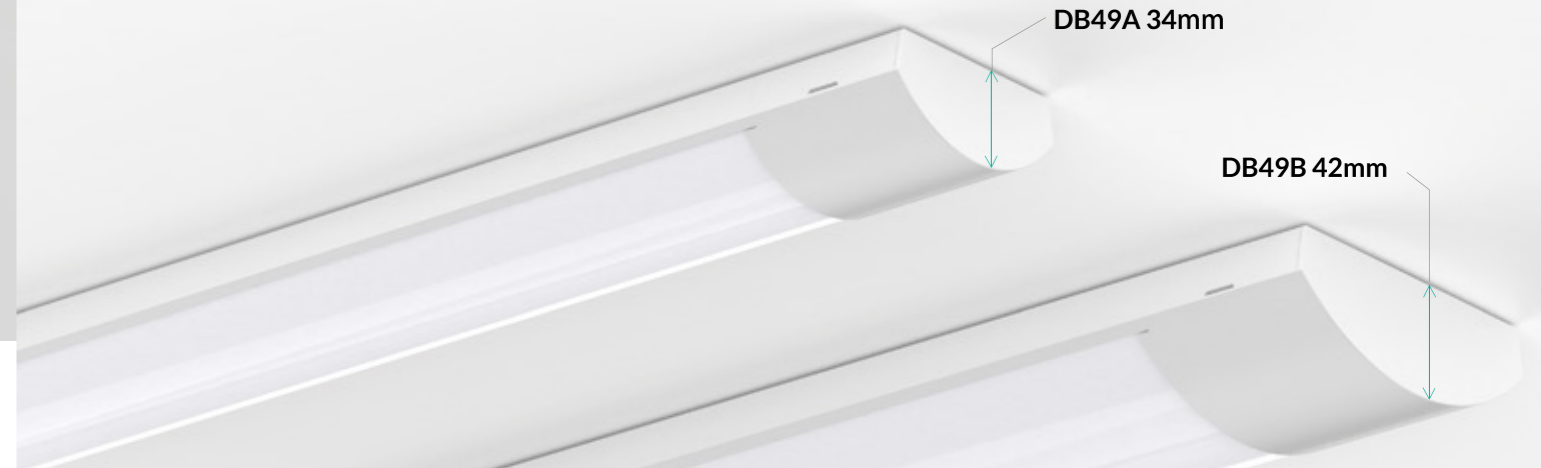

LED Linear & Batten light



DB41 Batten

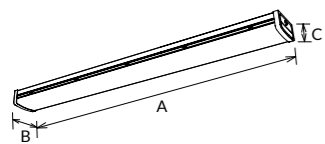

DB41 batten lamp adopts separated module design, has been improved to have a wider lighting emitting area; color temperature and wattage both switchable. Suspended, surface mounted and splicing installation optional.

-
-
-
-
-
-
-
-
-
-
-
-
-

Code	Watt	Size(AxBxCmm)	Lumen(±5%)	N.W/pc(kgs)	Q'ty/CTN
DB41-600-25W	25W	600x124x68	2500lm	1.50	12PCS
DB41-1200-42W	42W	1200x124x68	4780lm	2.90	6PCS

CCT ——— 3000K 4000K 5000K 5700K

Finish ——— White Black

Installation accessories ———



DB124 Batten

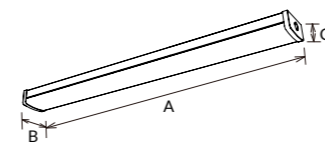

This batten light is a compact design, it adopts high lumen 2835 SMD chip and high transmittance PC shade to create a uniform light output. 130 degrees large lighting area with high lumen efficiency. Besides, it's a functional design, CCT changeable, microwave sensor available. Installation: pendant/surface mounted.

-
-
-
-
-
-
-
-
-
-
-
-
-
-

Code	Watt	Size(AxBxCmm)	Lumen(±5%)	N.W/pc(kgs)	Q'ty/CTN
DB124-600-20W	20W	600x124x60	1900lm	1.18	6PCS
DB124-1200-38W	38W	1200x124x60	3800lm	2.14	6PCS
DB124-1500-50W	50W	1500x124x60	5000lm	2.71	6PCS
DB124-1500-60W	60W	1500x124x60	6000lm	2.71	6PCS

CCT ——— 3000K 4000K 5000K 5700K

Finish ——— White

Installation accessories ——— Suspension kit



DB74 Batten

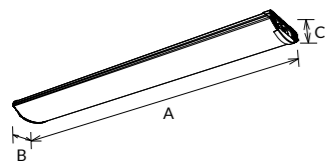

DB74 batten light is a compact design, it adopts high lumen 2835 SMD chip and high transmittance PC shade to create a uniform light output. Screwless design on back side with better looking, large lighting area with high lumen efficiency. Flicker free branded driver ensure a long lifespan, it's a great option for various applications. It is designed for school lighting applications, such as classrooms, libraries, etc.

- ▶ 120° IP44
- ▶ DALI Flicker Free SLIDE SWITCH 3 in 1 ((-)) ((-))
- ▶ AC 220-240V PF≥0.9 CRI≥80
- ▶ SAA RoHS CE

Code	Watt	Size(AxBxCmm)	Lumen(±5%)	N.W/pc(kgs)	Q'ty/CTN
DB74-600-17W	17W	595x171x63	1870lm	1.55	12PCS
DB74-1200-30W	30W	1195x171x63	3500lm	2.88	6PCS
DB74-1500-36W	36W	1495x171x63	4250lm	3.52	6PCS
DB74-1500-50W	50W	1495x171x63	6000lm	3.52	6PCS

CCT

3000K
4000K
5000K
5700K

Finish

White



DB175 Batten

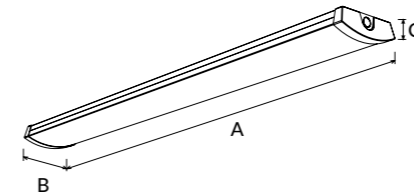

DB175 is a slim batten light with big lighting area, available with 3CCT, DALI dim, emergency, and sensor function. High lumen efficiency 130lm/W and 160lm/W.

- ▶ 110° IP44
- ▶ DALI Flicker Free SLIDE SWITCH 3 in 1 ((-)) ((-))
- ▶ AC 200-240V PF≥0.9 CRI≥80
- ▶ SAA RoHS CE

Code	Watt	Size(AxBxCmm)	Lumen(±5%)	N.W/pc(kgs)	Q'ty/CTN
DB175-600-20W	20W	600x148x50	2600lm	1.10	12PCS
DB175-1200-40W	40W	1200x148x50	5200lm	2.00	6PCS
DB175-1500-55W	55W	1500x148x50	7150lm	2.40	6PCS
DB175-600-20W	20W	600x148x50	3200lm	1.10	12PCS
DB175-1200-40W	40W	1200x148x50	6400lm	2.00	6PCS
DB175-1500-55W	55W	1500x148x50	8800lm	2.40	6PCS

CCT

3000K
4000K
5000K
5700K

Finish

White

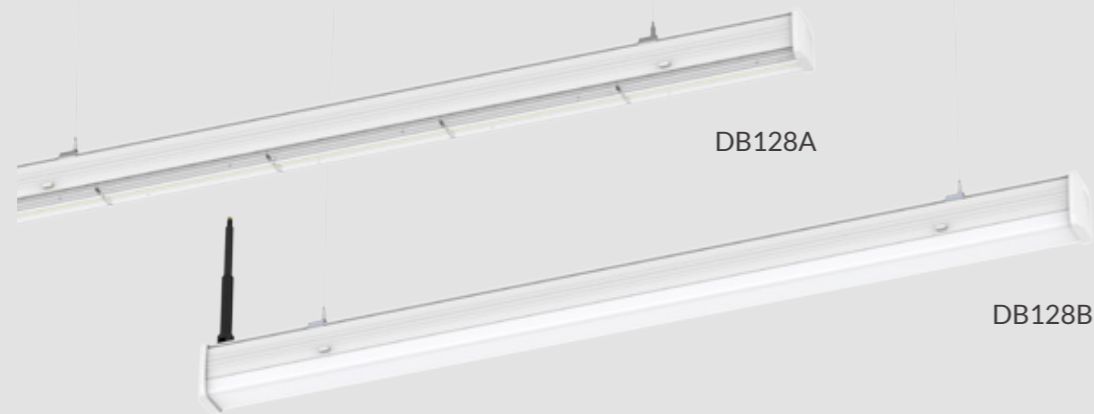

DB128 Trunking System

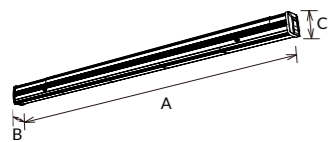

DB128 LED Linear Track Light adopts separated module design with track, linear light and functional modules. For track, 5-wire/8-wire/12-wire selectable, splicing with L/T/X node connector and different entry hole can support a flexible installation, so it is the optimal solution for conventional lighting systems and also excellent for new installations due to its low installation cost. Power selectable by dip switch. DALI dimming, Emergency, Sensor for more application demands. Multifit for Surface mounting, steel wire suspension, rod suspension and chain suspension.

- ▶ 30° 60° 90° 120°
- ▶ 30° 30° IP20
- ▶ DIM DALI Flicker Free Human silhouette Signal waves
- ▶ AC 200-240V PF≥0.9 CRI≥80
- ▶ SAA RoHS CE

LED LINEAR LIGHTING SYSTEM

Separated module design with track, linear light and functional modules

Code	Watt	Size(AxBxCmm)	Lumen(±5%)	N.W/pc(kgs)	Q'ty/CTN
DB128A-1500-40W-A4	28W/33W/36W/40W	1498x71.4x71.5	6150lm/7050lm/7500lm/8400lm	2.00	4PCS
DB128A-1500-60W-A4	45W/50W/55W/60W	1498x71.4x71.5	9550lm/10550lm/11550lm/12550lm	2.00	4PCS
DB128A-1500-74W-A3	62W/68W/74W	1498x71.4x71.5	12200lm/13600lm/14650lm	2.00	4PCS
DB128B-1500-40W-A4	28W/33W/36W/40W	1498x71.4x86.5	4400lm/5150lm/5500lm/6000lm	1.50	4PCS
DB128B-1500-60W-A4	45W/50W/55W/60W	1498x71.4x86.5	7050lm/7700lm/8300lm/8900lm	1.50	4PCS
DB128B-1500-74W-A3	62W/68W/74W	1498x71.4x86.5	9350lm/10200lm/10500lm	1.50	4PCS

CCT 3000K 4000K 5000K 5700K

Finish White

Installation accessories Surface mounted kit

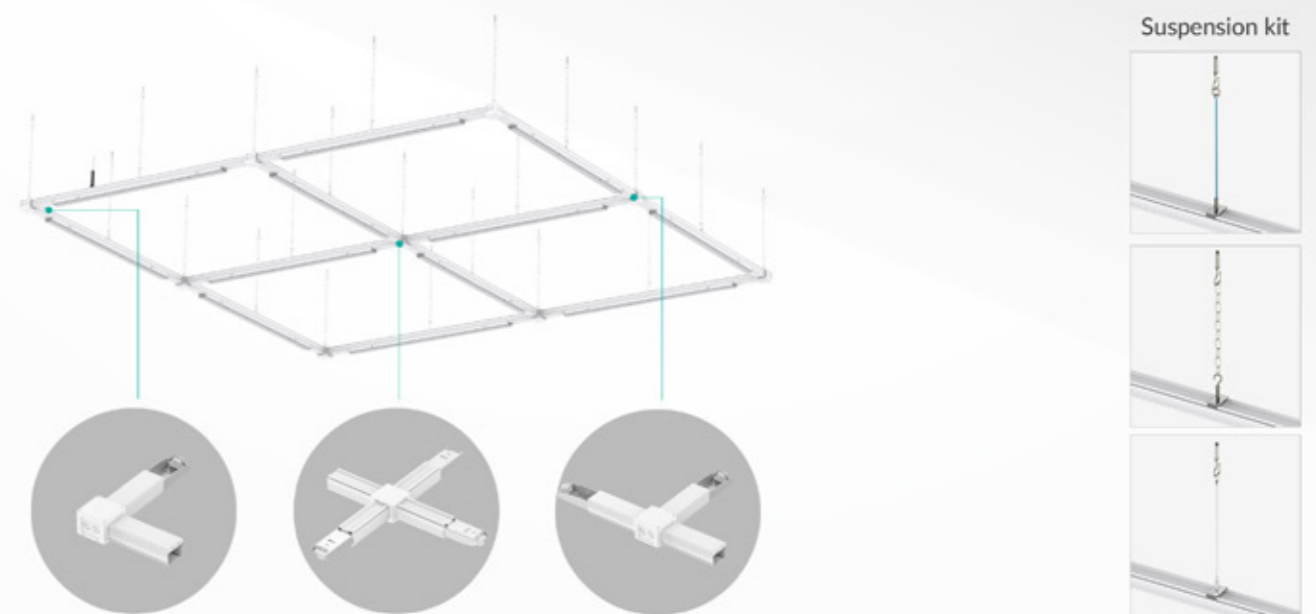

LED Linear & Batten light



DB68 Vapor proof

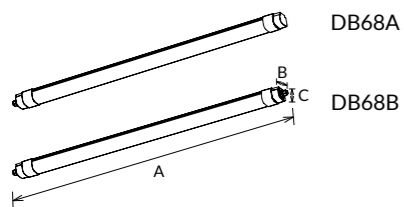

DB68 is an IP66 waterproof IK10 rated luminaire. Adopt 3x2 poles push in wire terminal block. It provides through-wiring for further luminaires (safety class II) connection. Tool free mains cable installation on both sides.

- ▶ 140° IP66 IK10
- ▶ Flicker Free
- ▶ AC 100-277V PF ≥ 0.9 CRI ≥ 80
- ▶ SAA RoHS CE CB

Code	Watt	Size(AxBxCmm)	Lumen(±5%)	N.W/pc(kgs)	Q'ty/CTN
DB68A-700-20W	20W	700x78.3x58.6	2300lm	0.50	12PCS
DB68A-1300-40W	40W	1300x78.3x58.6	4680lm	0.80	8PCS
DB68A-1600-50W	50W	1600x78.3x58.6	6000lm	0.95	6PCS
DB68B-700-20W	20W	700x78.3x58.6	2300lm	0.50	12PCS
DB68B-1300-40W	40W	1300x78.3x58.6	4680lm	0.80	8PCS
DB68B-1600-50W	50W	1600x78.3x58.6	6000lm	0.95	6PCS

CCT 3000K 4000K 5000K 5700K

Finish White Black

Installation accessories Suspension kit

Linkable suggested luminaries Qty (200-240V) 20W-52PCS 40W-26PCS 50W-21PCS

DB18 Vapor proof

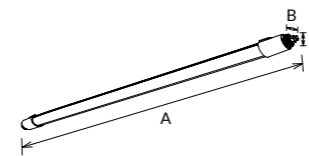

DB18 is a high quality LED batten with high luminous efficacy 115lm/w. With a reliable and robust housing structure (IK10 & IP66). Three options of length (700mm/1300mm/1600mm), and various lumen package, let it to be an ideal replacement for traditional fluorescent batten.

- ▶ 140° IP66
- ▶ Flicker Free
- ▶ AC 100-277V PF ≥ 0.9 CRI ≥ 80
- ▶ SAA RoHS CE

Code	Watt	Size(AxBxCmm)	Lumen(±5%)	N.W/pc(kgs)	Q'ty/CTN
DB18-700-20W	20W	700x78x53.5	2300lm	0.60	12PCS
DB18-1300-25W	25W	1300x78x53.5	3050lm	0.80	8PCS
DB18-1300-30W	30W	1300x78x53.5	3450lm	0.80	8PCS
DB18-1300-40W	40W	1300x78x53.5	4680lm	0.80	8PCS
DB18-1600-40W	40W	1600x78x53.5	4680lm	1.00	6PCS
DB18-1600-50W	50W	1600x78x53.5	6000lm	1.00	6PCS

CCT 3000K 4000K 5000K 5700K

Finish White Black

Installation accessories Suspension kit

Linkable suggested luminaries Qty (200-240V) 20W-52PCS 40W-26PCS 50W-21PCS



DB129 Vapor proof

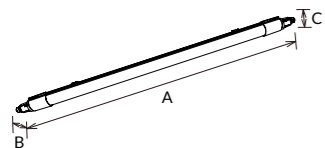

DB129 adopts high lumen SMD chip, the high transmittance PC cover makes a uniform and soft light output. Interchangeable CCT with slide switch and it can also do Microwave Sensor , IP66 waterproof and IK08 available.

- ▶
- ▶
- ▶
- ▶

Code	Watt	Size(AxBxCmm)	Lumen(±5%)	N.W/pc(kgs)	Q'ty/CTN
DB129A/B-600-20W	20W	600x70x57	2100lm	0.45	12PCS
DB129A/B-1200-40W	40W	1200x70x57	4700lm	0.65	12PCS
DB129A/B-1500-48W	48W	1500x70x57	6100lm	0.75	12PCS

CCT ——— 3000K 4000K 5000K 5700K Finish ——— White Black

Installation accessories ——— Suspension kit



Linkable suggested luminaries Qty (200-240V) ——— 0.6m-24PCS 1.2m-12PCS 1.5m-9PCS



DB169 Vapor proof

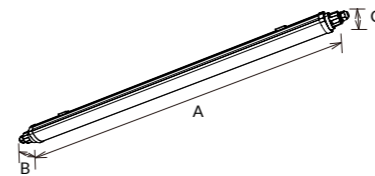

DB169 vapor batten adopts high lumen efficiency SMD light source reach to 120lm/W, PC cover is internal stripe design which makes a uniform light output. Tool free mains cable installation on both sides through twist lock fastener cover at both sides. With a reliable and robust housing structure (IK08 & IP65). 3-CCT changeable is available and DB169A can splicing to 1200W max.

- ▶
- ▶
- ▶
- ▶

Code	Watt	Size(AxBxCmm)	Lumen(±5%)	N.W/pc(kgs)	Q'ty/CTN
DB169A-600-18W	18W	600x66x54	2100lm	0.42	12PCS
DB169A-600-18W	18W	600x66x54	2400lm	0.42	12PCS
DB169A-1200-33W	33W	1200x66x54	4000lm	0.75	12PCS
DB169A-1200-33W	33W	1200x66x54	4550lm	0.75	12PCS
DB169A-1500-46W	46W	1500x66x54	6000lm	0.91	12PCS
DB169A-1500-46W	46W	1500x66x54	6350lm	0.91	12PCS
DB169B-600-18W	18W	538x66x54	2100lm	0.37	12PCS
DB169B-600-18W	18W	538x66x54	2400lm	0.37	12PCS
DB169B-1200-33W	33W	1138x66x54	4000lm	0.69	12PCS
DB169B-1200-33W	33W	1138x66x54	4550lm	0.69	12PCS
DB169B-1500-46W	46W	1438x66x54	6000lm	0.84	12PCS
DB169B-1500-46W	46W	1438x66x54	6350lm	0.84	12PCS

CCT ——— 3000K 4000K 5000K 5700K Finish ——— Grey

Installation accessories ——— Suspension kit

Linkable suggested luminaries Qty (200-240V) ——— 18W-66PCS 40W-30PCS 46W-26PCS



DB145 Vapor proof

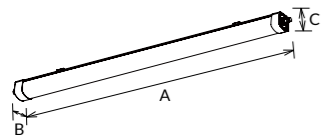

DB145 is a high quality LED batten with high luminous efficacy 150lm/w. With a reliable and robust housing structure (IK08 & IP65), this maximizes the endurance and contributes to its long lifetime. With its flexible installation accessories, it can be installed for surface mount, pendant and splicing installation ways. 1200mm, 1500mm, 1800mm are available, it's an ideal replacement for traditional fluorescent batten.

- ▶
- ▶
- ▶
- ▶

Code	Watt	Size(AxBxCmm)	Lumen(±5%)	N.W/pc(kgs)	Q'ty/CTN
DB145-1200-38W	38W	1200x77x69	5700lm	1.70	6PCS
DB145-1500-52W	52W	1500x77x69	8000lm	2.10	6PCS
DB145-1500-68W	68W	1500x77x69	9800lm	2.10	6PCS
DB145-1800-68W	68W	1800x77x69	10000lm	2.30	6PCS

CCT ——— 3000K 4000K 5000K 5700K

Finish ——— White

Installation accessories ——— Suspension kit

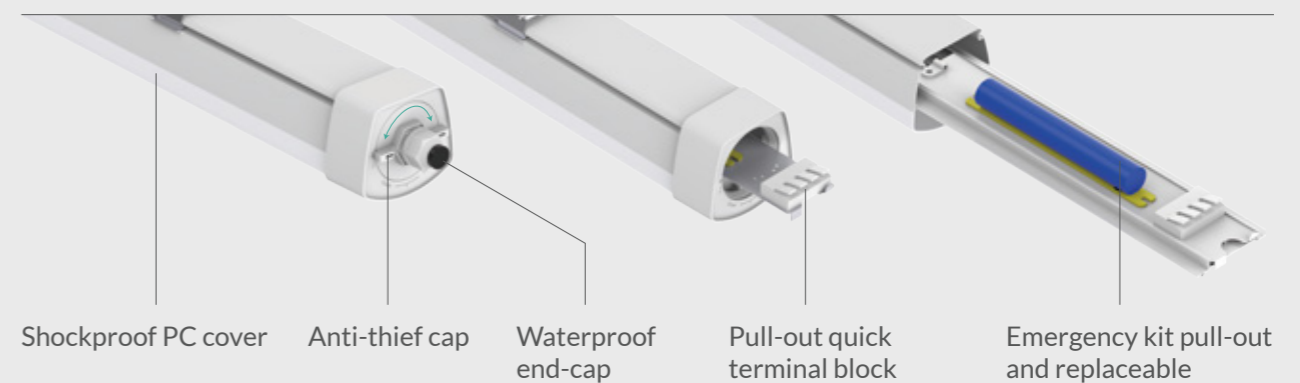

- Shockproof PC cover
- Anti-thief cap
- Waterproof end-cap
- Pull-out quick terminal block
- Emergency kit pull-out and replaceable



LED Wall & Spike Light & Mirror Light

/Series/

ELWA has been developing a series of wall lights and spike lights in recent years. More and more fashionable and brilliant products are self-designed. Equipped with new sensor function, up and down lighting, beam angle adjustable version, and IP65 waterproof, ELWA led wall light family provide various solutions for project and distribution. All wall lights can be used for both indoor corridors and outdoor courtyard. ELWA has received much favor and love from our customers.

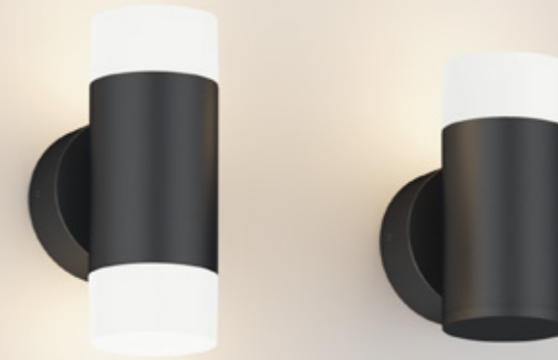

WL28B

WL28C

WL28 Exterior wall light

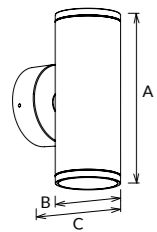

WL28 as one of the UP and DOWN wall light in ELWA, which is IP65 and IK08 with AL6063 aluminum and UV resistance for outdoor application, the wide voltage 100~240V could be used all over the world. Meanwhile, the isolated driver and high light efficiency wins lots of good feedback from market.

- ▶ 15° 24° 36° 60°
- ▶ IP65
- ▶ Flicker Free
- ▶ AC 100-240V PF≥0.9 CRI≥80
- ▶ SAA RoHS CE

Code	Watt	Size(AxBxCmm)	Lumen(±5%)	N.W/pc(kgs)	Q'ty/CTN
WL28-10W	2x5W	170x60x105	900lm	0.60	18PCS
WL28-20W	2x10W	200x76x121	2200lm	0.90	18PCS
WL28-27W	2x13.5W	230x100x145	3200lm	1.20	12PCS

CCT ——— 2700K 3000K 4000K 5000K Finish ——— White Black Silver

WL28B/C Exterior wall light

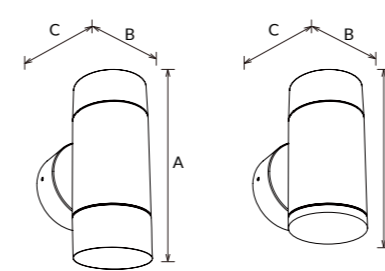

WL28B is a LED wall light with cylindrical design. 360 degree beam angle can provide brilliant lighting performance. Only upwards lighting direction and up&down lighting direction for option. It is aluminum material and IP65 waterproof. Dim and CCT changeable are available.

- ▶ 15° 24° 36° 60°
- ▶ IP65
- ▶ DIM Flicker Free SLIDE SWITCH 3 in 1
- ▶ AC 220-240V PF≥0.9 CRI≥80
- ▶ SAA RoHS CE

Code	Watt	Size(AxBxCmm)	Lumen(±5%)	N.W/pc(kgs)	Q'ty/CTN
WL28B-60-8W	2x4W	175x95x100	720lm	0.60	12PCS
WL28C-60-5W	5W	145x95x100	450lm	0.60	12PCS
WL28B-76-8W	2x4W	195x95x116	720lm	0.90	12PCS
WL28B-76-15W	2x7.5W	195x95x116	1440lm	0.90	12PCS
WL28C-76-8W	8W	161x95x116	720lm	0.90	12PCS

CCT ——— 2700K 3000K 4000K 5000K Finish ——— White Black



WL85 Exterior wall light

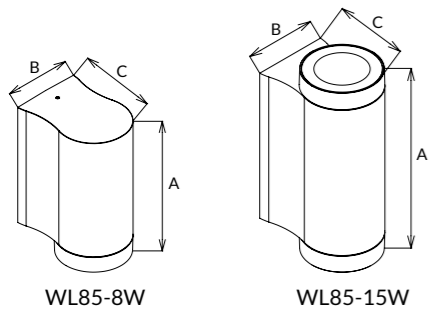

WL85 is a SMD UP&Down wall light with internal non-dim/Traic dim driver , ADC12 Aluminum body provides excellent thermal dissipation. Interchangeable CCT with slide switch is available , IP65 waterproof suitable for indoor and outdoor use, loop in/out entry for more applications.

- ▶ 45°
- ▶
- ▶
- ▶

Code	Watt	Size(AxBxCmm)	Lumen(±5%)	N.W/pc(kgs)	Q'ty/CTN
WL85-8W	8W	143x70x95	850lm	0.77	24PCS
WL85-15W	2x7.5W	179x70x95	1700lm	0.91	12PCS

CCT — 3000K 4000K 5000K 5700K

Finish — White Black

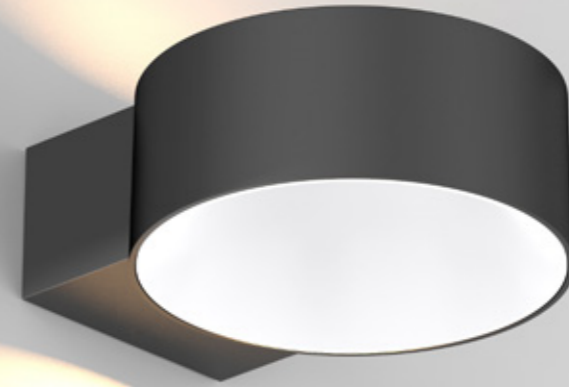

WL07C Exterior wall light

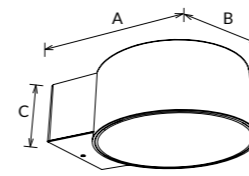

WL07C LED wall light provides a stylish architectural luminaire for interior applications by the unique form and up light and down light functional design. WL07C adopts aluminum housing which provides excellent thermal management and 94-V0 fire rated PC which distributes softly lighting to creating comfortable atmosphere.

- ▶ 140°
- ▶
- ▶
- ▶

Code	Watt	Size(AxBxCmm)	Lumen(±5%)	N.W/pc(kgs)	Q'ty/CTN
WL07C	8W	180x140x58.5	655lm	0.75	24PCS

CCT — 3000K 4000K 5000K 5700K

Finish — White Black

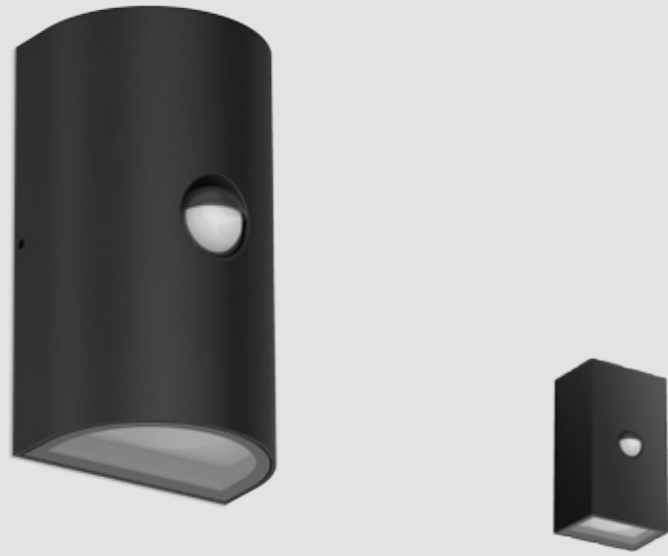

WL73 Exterior wall light

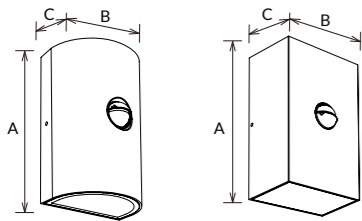

WL73 is a wall lamp with simple appearance. The products are divided into standard, sensor function and GU10 replaceable models, which have black, white and gray appearance. Two different attractive design are Up & Down design and 100% Down lighting distribution. A variety of light beam angle are as optional, high lumen COB used; aluminum lamp body with good heat-dissipation.

- ▶ 100° IP54
- ▶ Flicker Free ((·))
- ▶ AC 220-240V PF≥0.9 CRI≥80
- ▶ SAA RoHS CE

Code	Watt	Size(AxBxCmm)	Lumen(±5%)	N.W/pc(kgs)	Q'ty/CTN
WL73A-4.9W	4.9W	165x95x67	450lm	0.65	12PCS
WL73B-4.9W	4.9W	165x95x67	450lm	0.77	12PCS
WL73A-8W	8W	165x95x67	750lm	0.66	12PCS
WL73B-8W	8W	165x95x67	750lm	0.78	12PCS
WL73A-10W	10W	165x95x67	1000lm	0.61	12PCS
WL73B-10W	10W	165x95x67	1000lm	0.73	12PCS
WL73A-16W	16W	165x95x67	1600lm	0.63	12PCS
WL73B-16W	16W	165x95x67	1600lm	0.76	12PCS

CCT — 3000K 4000K 5000K 5700K Finish — White Black Silver

WL73A 4 Decorative patterns

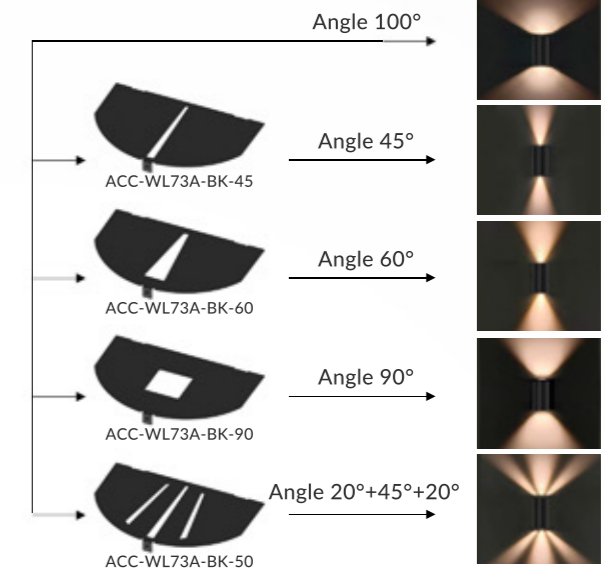
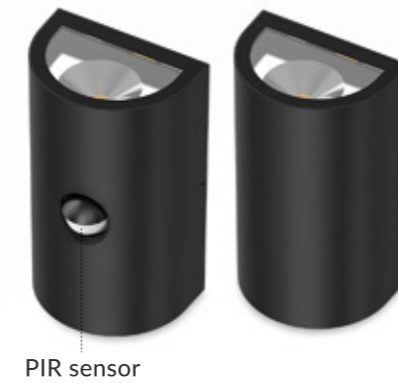

WL73B 4 Decorative patterns

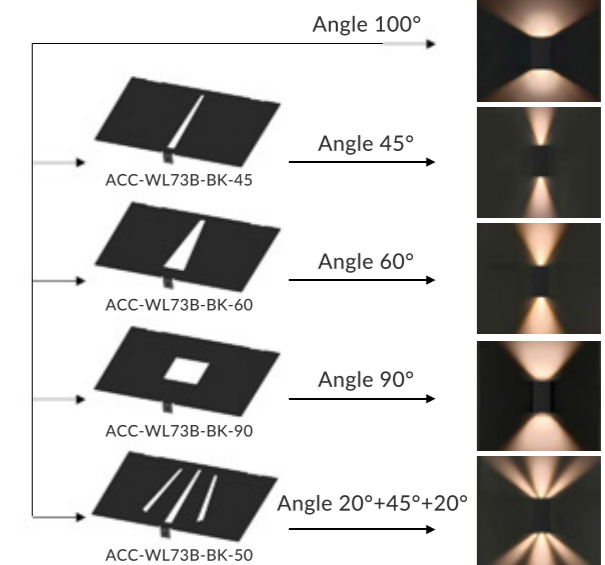
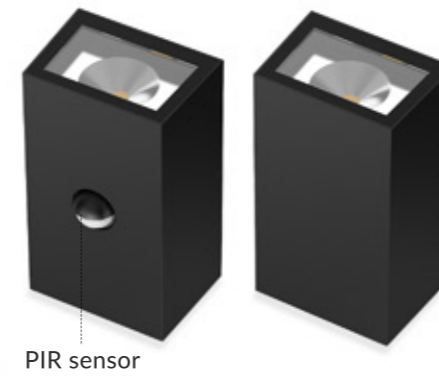

WL73-GU10

GU10 light source replaceable wall washer

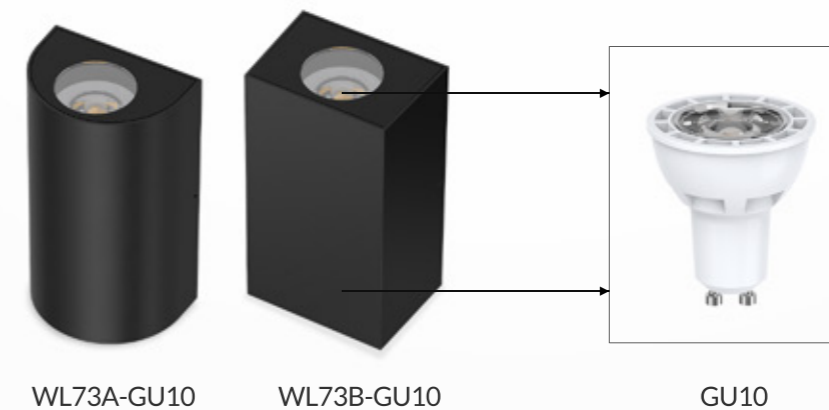



WL90A



WL90B

WL90A/B Exterior wall light

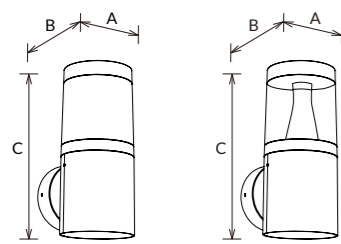

WL90 LED wall light provides a stylish architectural luminaire for outdoor applications. It milky PC cover for a uniform light output, and another WL90B combines reflector and transparent PC cover for down lighting. WL90A and WL90B's lighting module can be interchangeable. The ADC12 aluminum cylindrical lamp body with outdoor powder spray, anti-corrosion, IP65 and IK08 protection level make it a welcomed lamp in outdoor area.

- ▶ 320° 360° IP65 IK08
- ▶ DIM Flicker Free SLIDE SWITCH 2 in 1
- ▶ AC 220-240V PF≥0.9 CRI≥80
- ▶ SAA RoHS CE

Code	Watt	Size(AxBxCmm)	Lumen(±5%)	N.W/pc(kgs)	Q'ty/CTN
WL90A-8W	8W	100x142x230	750lm	1.00	12PCS
WL90B-8W	8W	100x142x230	620lm	1.00	12PCS

CCT ——— 3000K 4000K 5000K 5700K

Finish ——— White Black

Cover ——— ACC-WL90-BK ACC-WL/NL90B-BK-8W-D ACC-WL/NL90B-BK-8W-P2 ACC-WL/NL90A-BK-8W-D ACC-WL/NL90A-BK-8W-P2

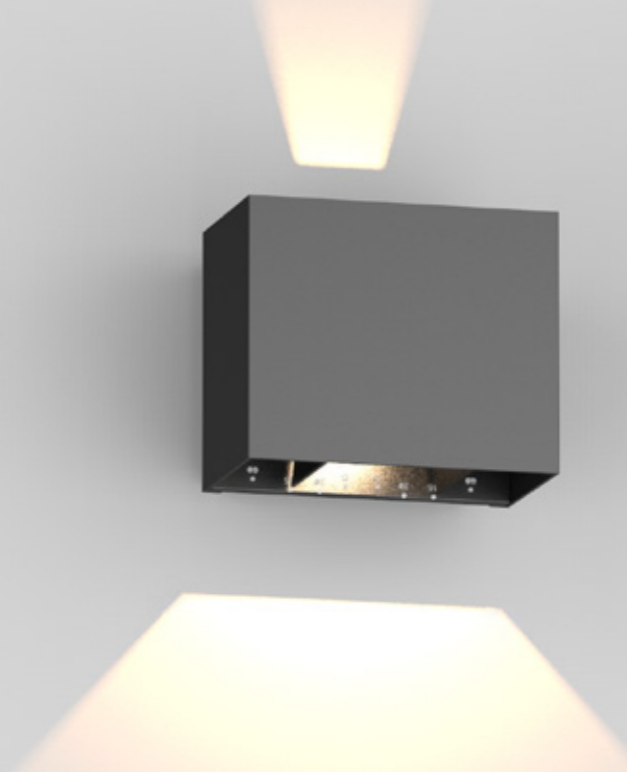

WL20 Exterior wall light

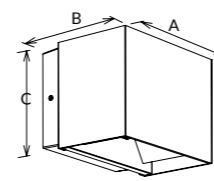

WL20 wall lamp adopts ADC12 aluminum housing which can provide excellent thermal management; it also with unique up and down light functional design ; the beam angle can be adjusted by the flexible aluminum plate. IP65 waterproof and Up & down luminous design.

- ▶ 15°~120° 15°~120° IP65
- ▶ DIM Flicker Free SLIDE SWITCH 2 in 1
- ▶ AC 200-240V PF≥0.9 CRI≥80
- ▶ SAA RoHS CE

Code	Watt	Size(AxBxCmm)	Lumen(±5%)	N.W/pc(kgs)	Q'ty/CTN
WL20-10W	2x5W	120x96.8x100	900lm	0.59	18PCS
WL20-18W	2x9W	242x97.7x100	1350lm	1.10	12PCS

CCT ——— 3000K 4000K 5000K 5700K

Finish ——— White Black

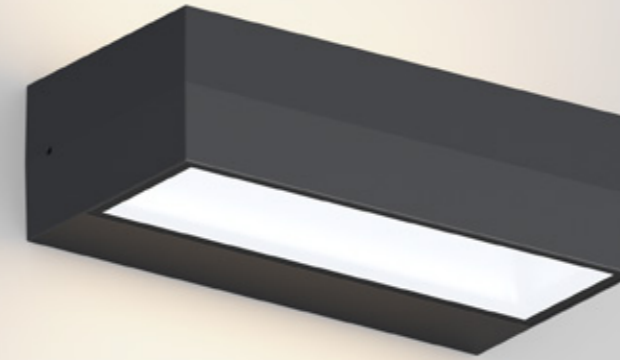

WL153 NEW Exterior wall light

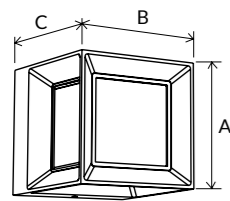

WL153 LED wall light is with their beautifully simple clean lines, 200° wide beam angle with 5 faces light output provide uniform light. Interchangeable CCT with slide switch is available, IP65, IK08 suitable for outdoor use.

- ▶ 200°
- ▶ IP65
- ▶ DIM
- ▶ Flicker Free
- ▶ SLIDE SWITCH 3 in 1
- ▶ ((••))
- ▶ AC 220-240V
- ▶ PF ≥ 0.9
- ▶ CRI ≥ 80
- ▶ SAA
- ▶ RoHS
- ▶ CE

Code	Watt	Size(AxBxCmm)	Lumen(±5%)	N.W/pc(kgs)	Q'ty/CTN
WL153-8W-D	8W	110x110x120	650lm	0.49	12PCS
WL153-8W-P3	8W	110x110x120	650lm	0.49	12PCS
WL153-15W-D	15W	250x110x120	1200lm	0.95	6PCS
WL153-15W-P3	15W	250x110x120	1200lm	0.95	6PCS

CCT ——— 3000K 4000K 5000K 5700K

Finish ——— White Black

WL88 Exterior wall light

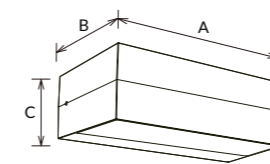

WL88 wall lamp is an up & down lighting design, the lamp body is made of aluminum die-casting, which has good heat dissipation, the lamp surface is sprayed with outdoor sand grain powder, which is corrosion resistant. Besides, it adopts SMD light source, so that can do CCT adjustable version. Strong structure design, IP65 waterproof will suit to a wider application area.

- ▶ 50°
- ▶ IP65
- ▶ DIM
- ▶ Flicker Free
- ▶ SLIDE SWITCH 3 in 1
- ▶ ((••))
- ▶ AC 220-240V
- ▶ PF ≥ 0.9
- ▶ CRI ≥ 80
- ▶ SAA
- ▶ RoHS
- ▶ CE

Code	Watt	Size(AxBxCmm)	Lumen(±5%)	N.W/pc(kgs)	Q'ty/CTN
WL88-10W	10W	200x100x60	750lm	0.71	12PCS
WL88-15W	15W	300x100x60	1100lm	1.09	12PCS
WL88-10W-P3(Switchable)	10W	200x100x60	700lm	0.71	12PCS

CCT ——— 3000K 4000K 5000K 5700K

Finish ——— White Black

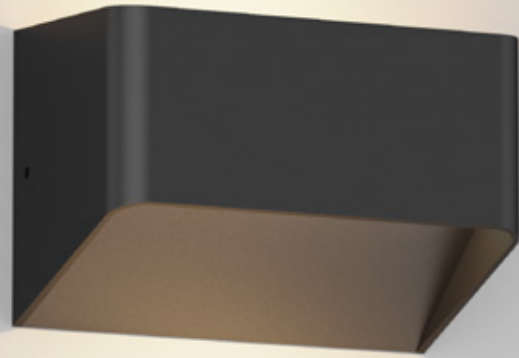

WL16 Exterior wall light

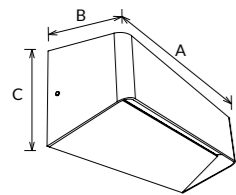

WL16 wall light adopts traditional design to satisfy public aesthetic view, the up and down design meet classic demand and distributes perfect lighting effects. IP54 and IK08 with fire-rated 94-V0 PC make your life more comfortable.

- ▶ 100°
 IP54
- ▶ DIM Flicker Free
- ▶ AC 220-240V PF≥0.9 CRI≥80
- ▶ SAA RoHS CE

Code	Watt	Size(AxBxCmm)	Lumen(±5%)	N.W/pc(kgs)	Q'ty/CTN
WL16-1510-10W	2x5W	150x92x100	500lm	0.54	24PCS
WL16-3010-18W NEW	2x9W	300x92x100	900lm	1.05	12PCS
WL16-3010-18W NEW	18W(Switchable)	300x92x100	1200lm	1.09	12PCS

CCT — 3000K 4000K 5000K 5700K

Finish — White Black



WL112 Exterior wall light

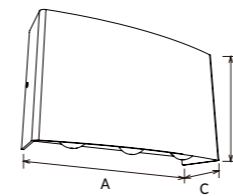

This square wall lamp is an IP65 and direct&indirect lighting design. Die-cast aluminium housing with sand grain powder making it more texture and better for heat dissipation. The optical part is made of PC material but special shape, PC frosted cover is used to prevent the front dazzling so that the lighting is clear and clean. Variety of mounting holes offers more options for different install condition, meanwhile it's a good choice to modern contemporary designs for residential or commercial applications.

- ▶ 30°x20°
 IP65 IK06
- ▶ Flicker Free
- ▶ AC 220-240V PF≥0.8 CRI≥80
- ▶ SAA RoHS CE

Code	Watt	Size(AxBxCmm)	Lumen(±5%)	N.W/pc(kgs)	Q'ty/CTN
WL112-6W	2x3W	L165xW94xH48.5	350lm	0.42	24PCS

CCT — 3000K 4000K 5000K 5700K

Finish — Grey White Black

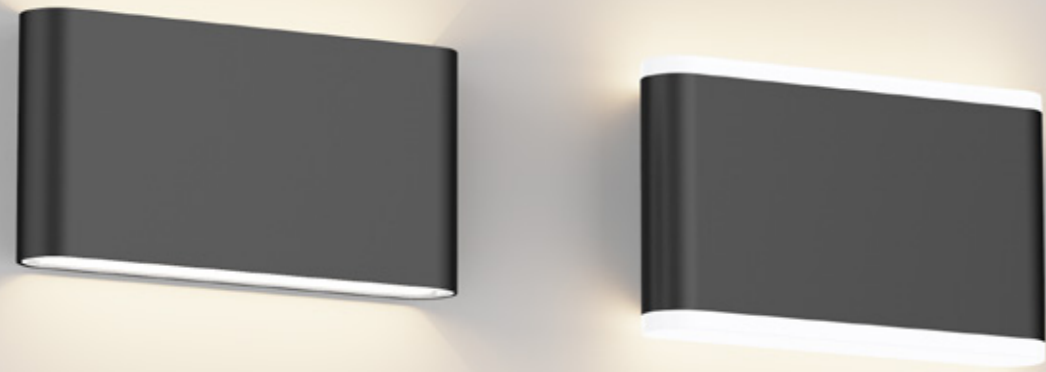

B



WL75 Exterior wall light

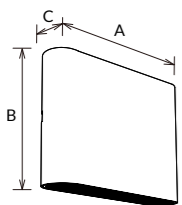

WL75 is an ultra-thin only 30.5mm design, which looks like a power bank. It adopted SMD light source in both ends with PC lens, wall-washing design for optic effect, so it can do higher and further lighting. For material part, it adopted ADC12 aluminium which offers a great heat dissipation. Besides, it is an up and down lighting design which can achieve a better atmosphere. Wall-washer design with polarized lens 8 degree more welcomed, IP65 waterproof will suit to a wider application area. It is designed for indoor and outdoor lighting applications hotel, park, and corridors etc.

- ▶ 29°x77°x8°
29°x77°x8°
- ▶ Flicker Free
- ▶ IP65
- ▶ IK08
- ▶ AC 220-240V
- ▶ PF ≥ 0.9
- ▶ CRI ≥ 80
- ▶ SAA
- ▶ RoHS
- ▶ CE

Code	Watt	Size(AxBxCmm)	Lumen(±5%)	N.W/pc(kgs)	Q'ty/CTN
WL75-6W	6W	135x90x30.5	680lm	0.47	18PCS
WL75B-6W	6W	135x104x30.5	530lm	0.47	18PCS
WL75-10W	2x5W	175x90x30.5	1060lm	0.57	18PCS
WL75B-10W	2x5W	175x104x30.5	840lm	0.57	18PCS

CCT — 3000K 4000K 5000K 5700K

Finish — White Black

WL108 Exterior wall light

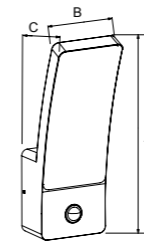

WL108 wall lamp is a scene lighting design with inclined plane polarization 15 degrees. It adopts PC lamp shade and ADC12 Aluminum housing, both sensor and CCT changeable function available. IP65 for both indoor and outdoor use.

- ▶ 120°
- ▶ Flicker Free
- ▶ SLIDE SWITCH 3 in 1
- ▶ IP65
- ▶ AC 200-240V
- ▶ PF ≥ 0.9
- ▶ CRI ≥ 80
- ▶ SAA
- ▶ RoHS
- ▶ CE

Code	Watt	Size(AxBmm)	Lumen(±5%)	N.W/pc(kgs)	Q'ty/CTN
WL108-10W	10W	Ø82x235	1050lm	0.68	12PCS
WL108-20W	20W	Ø110x310	2150lm	1.16	12PCS

CCT — 3000K 4000K 5000K 5700K

Finish — White Black

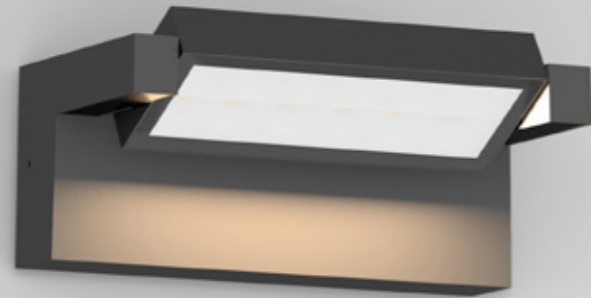

WL57 Exterior wall light

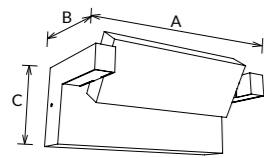

WL57 wall light is with adjustable head 240 degree (30 degree clockwise, 210 degree counterclockwise). ADC12 aluminum housing provides an excellent thermal management. IP65 and IK06 rating for outdoor lighting. Type A with frosted tempered glass and Type B with clear tempered glass.

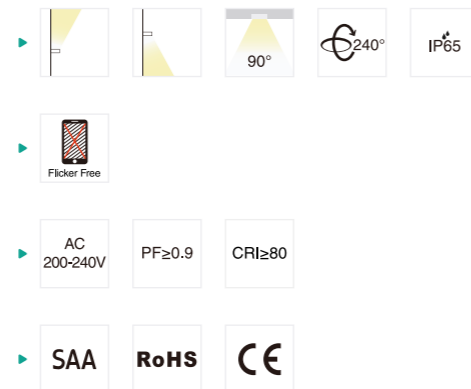

Code	Watt	Size(AxBxCmm)	Lumen(±5%)	N.W/pc(kgs)	Q'ty/CTN
WL57A-10W	10W	203x108x80	1050lm	0.85	12PCS
WL57B-10W	10W	203x108x80	1200lm	0.85	12PCS
WL57A-18W	18W	203x108x80	1800lm	0.85	12PCS
WL57B-18W	18W	203x108x80	2000lm	0.85	12PCS

CCT — 3000K 4000K 5000K 5700K

Finish — White Black

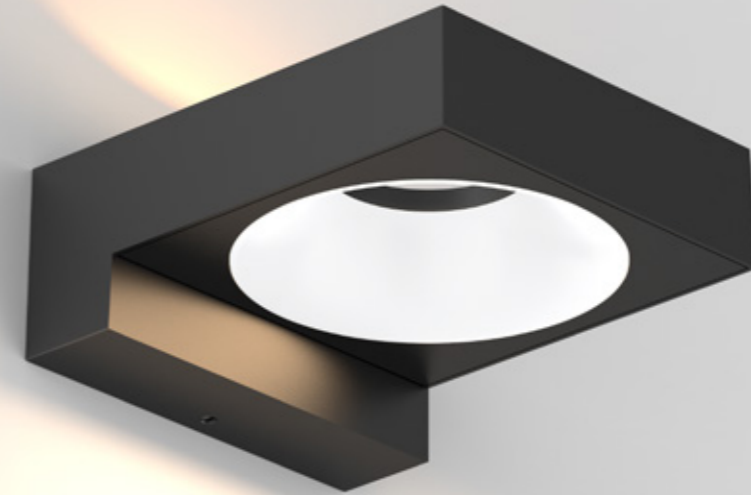

WL08 Exterior wall light

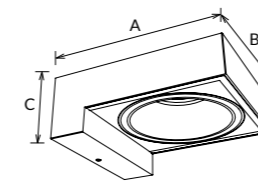

WL08 LED wall light is up and down design with internal driver, adopts aluminum housing provides excellent thermal dissipation, the 94-V0 fire rated PC distributes soft and unique light, IP65 suitable for both indoor and outdoor use.

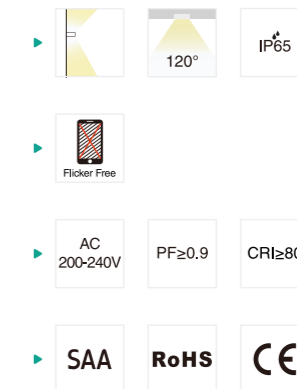

Code	Watt	Size(AxBxCmm)	Lumen(±5%)	N.W/pc(kgs)	Q'ty/CTN
WL08-8W	8W	139x115x52	670lm	0.42	24PCS

CCT — 3000K 4000K 5000K 5700K

Finish — White Black



WL91 Exterior wall light

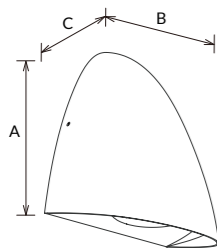

WL91 wall lamp adopts SMD light source, the tempered glass cover with high light transmittance which offers a uniform light output. ADC12 aluminum housing with arc surface larger heat dissipation area which provide an excellent thermal management. IP65 waterproof for outdoor application area. Interchangeable CCT with slide switch. Support triac dimming for single CCT version. It can be installed in upward or downward.

- ▶ 45°
- ▶ IP65
- ▶ IK06
- ▶ DIM
- ▶ Flicker Free
- ▶ SLIDE SWITCH 3 in 1
- ▶ AC 220-240V
- ▶ PF ≥ 0.9
- ▶ CRI ≥ 80
- ▶ SAA
- ▶ RoHS
- ▶ CE

Code	Watt	Size(AxBxCmm)	Lumen(±5%)	N.W/pc(kgs)	Q'ty/CTN
WL91-8W	8W	202x121x95	800lm	0.50	12PCS

CCT — 3000K 4000K 5000K 5700K

Finish — White Black



WL110 Exterior wall light

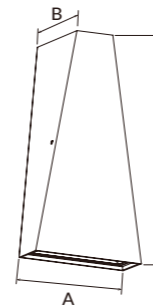

WL110 is a rhombus shape design wall light with Up/Down lighting. It adopts ADC12 aluminum housing and PC lamp shade to ensure reliable thermal management and uniform light output. IP65 design for both indoor and outdoor use.

- ▶ 120°
- ▶ IP65
- ▶ Flicker Free
- ▶ SLIDE SWITCH 3 in 1
- ▶ AC 220-240V
- ▶ PF ≥ 0.9
- ▶ CRI ≥ 80
- ▶ SAA
- ▶ RoHS
- ▶ CE

Code	Watt	Size(AxBxCmm)	Lumen(±5%)	N.W/pc(kgs)	Q'ty/CTN
WL110-6W	2x3W	100x80x200	460lm	0.69	12PCS

CCT — 2700K 3000K 4000K 5000K

Finish — White Black



WL130 NEW Exterior wall light

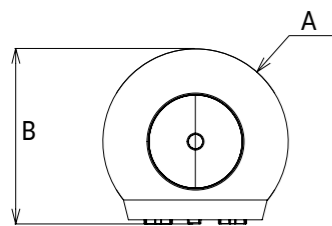

WL130 is LED wall light with Spherical design. Light up and side makes luminous performance more soft and comfortable. The aluminum housing provides good heat dissipation. IP65 waterproof is available.

- ▶ 90°
- ▶
- ▶
- ▶

Code	Watt	Size(AxBmm)	Lumen(±5%)	N.W/pc(kgs)	Q'ty/CTN
WL130-3W	3W	Ø100x95	260lm	0.65	24PCS
WL130-6W	6W	Ø100x95	540lm	0.60	24PCS
WL130-8W	8W	Ø100x95	760lm	0.50	24PCS

CCT — 2700K — 3000K — 4000K — 5000K

Finish — White Black



WL105 Exterior wall light

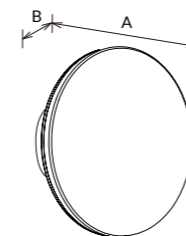

WL105 is a wall lamp with backlit design; simple style and backlit design is used to scene lighting. The lamp body is made of aluminum die-casting, it adopts SMD light source, IP65, IK08 protection class. Adopt high lumen SMD LED light source with CCT changeable.

- ▶ 120°
- ▶
- ▶
- ▶

Code	Watt	Size(AxBmm)	Lumen(±5%)	N.W/pc(kgs)	Q'ty/CTN
WL105-8W	8W	Ø160x50	640lm	0.50	18PCS
WL105-15W	15W	Ø250x50	1260lm	1.00	12PCS

CCT — 3000K — 4000K — 5000K

Finish — Black



CYLINDER SHAPE

Wall Light-WL52



WL52 Exterior wall light

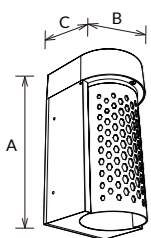

WL52 LED wall light with flexible combination design. IP65 waterproof. Two lampshades optional: PC lampshade and metal grille lampshade(can be replaceable), combined with same lamp body, offer more choice for different architectural buildings. Each lampshade can be convexity or concave surface installation, provide different mood lighting effect. The upward or downward lighting installation, make 2 x luminaires can be combined together to achieve up and down lighting effect.

- ▶ 30° IP65
- ▶ Flicker Free 3 in 1
- ▶ AC 220-240V PF≥0.9 CRI≥80 CRI≥90
- ▶ SAA RoHS CE

Code	Watt	Size(AxBxCmm)	Lumen(±5%)	N.W/pc(kgs)	Q'ty/CTN
WL52-10W	10W	229x113x120	550lm	1.59	6PCS
WL52-10W-C3	10W	229x113x120	400lm	1.62	6PCS

CCT ——— 2700K 3000K 4000K 5000K 6500K

Finish ——— Black

Cover ——— Metal grille shade ACC-WL52-CU Metal grille shade ACC-WL52-CR PC shade ACC-WL52-BK

LAMPSHADE SWITCHING

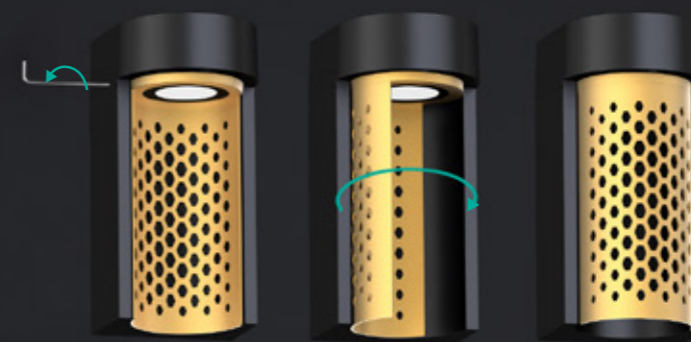

TWO LAMPSHADE OPTIONS

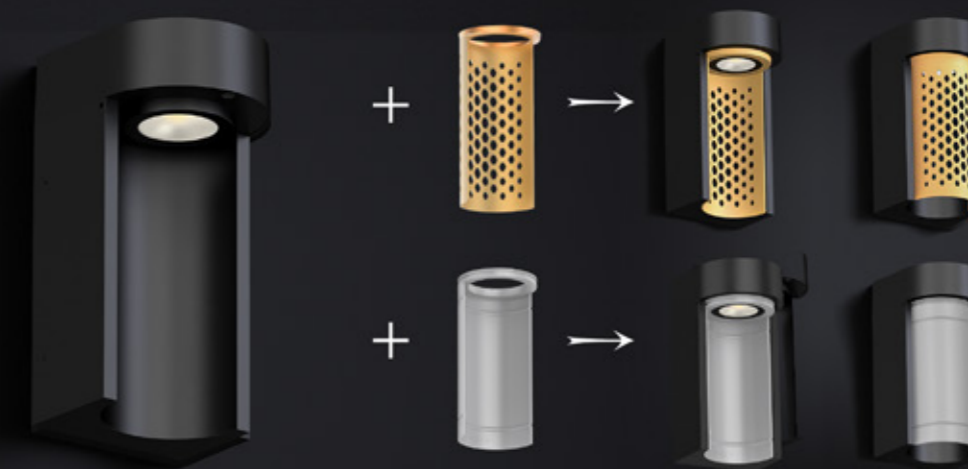



WL80 Exterior wall light

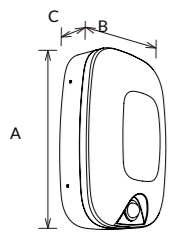

WL80 is a frameless wall lamp with a large light-emitting surface. The frameless lampshade design creates a more stereoscopic lighting environment. For material part, it adopts SMD light source, PC cover offers a uniform light output. ADC12 aluminum lamp body could provide a great thermal management. Besides, multiple functions such as CCT changeable, PIR sensor, triac dim, rated IP65 waterproof, which offer a wider choices for more applications.

- ▶ PIR Sensor
- ▶ 120°
- ▶ IP65
- ▶ IK08
- ▶ DIM
- ▶ Flicker Free
- ▶ SLIDE SWITCH 3 in 1
- ▶ PIR Sensor
- ▶ AC 220-240V
- ▶ PF≥0.9
- ▶ CRI≥80
- ▶ SAA
- ▶ RoHS
- ▶ CE

Code	Watt	Size(AxBxCmm)	Lumen(±5%)	N.W/pc(kgs)	Q'ty/CTN
WL80-12W	12W	251x167x80	1400lm	0.95	12PCS
WL80-18W	18W	251x167x80	1900lm	0.95	12PCS

CCT — 3000K 4000K 5000K 5700K

Finish — White Black

WL76 Exterior wall light

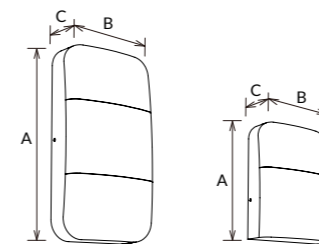

WL76 is a compact wall light with IP65 waterproof design. Single head/double heads optional, provide up/up & down lighting choice according to application. It adopts SMD light source in both ends with PC diffuser, offers a uniform light output. Aluminium material offer great heat dissipation. Single or double holes wiring, convenient installation. Interchangeable CCT is optional.

- ▶ 120°
- ▶ IP65
- ▶ Flicker Free
- ▶ SLIDE SWITCH 3 in 1
- ▶ AC 220-240V
- ▶ PF≥0.9
- ▶ CRI≥80
- ▶ SAA
- ▶ RoHS
- ▶ CE

Code	Watt	Size(AxBxCmm)	Lumen(±5%)	N.W/pc(kgs)	Q'ty/CTN
WL76-7W	7W	177x130x54	750lm	0.64	12PCS
WL76-7W-C3	7W	177x130x54	760lm	0.64	12PCS
WL76-14W	2x7W	240x130x54	1420lm	0.78	12PCS
WL76-14W-C3	2x7W	240x130x54	1430lm	0.78	12PCS

CCT — 3000K 4000K 5000K 5700K

Finish — White Black

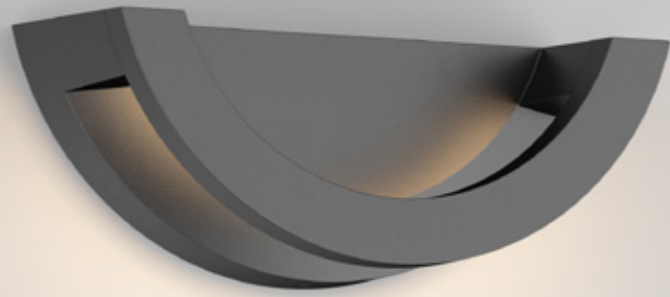

WL46 Exterior wall light

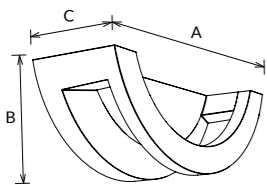

WL46 LED wall light wins 2020 IF Award, adopting high lumen SMD, aluminum body with great thermal management. It is IP65 IK08 high protection. Indirect lighting design offers a great visual experience. Various DIY shape is available.

- ▶ 50°
- ▶ IP65
- ▶ IK08
- ▶ Flicker Free
- ▶ AC 200-240V
- ▶ PF ≥ 0.9
- ▶ CRI ≥ 80
- ▶ SAA
- ▶ RoHS
- ▶ CE

Code	Watt	Size(AxBxCmm)	Lumen(±5%)	N.W/pc(kgs)	Q'ty/CTN
WL46-10W	10W	204x81x78	530lm	0.50	24PCS

CCT ——— 3000K 4000K 5000K 5700K

Finish ——— White Black

Indirect lighting like
RAINBOW
DIY shape installation

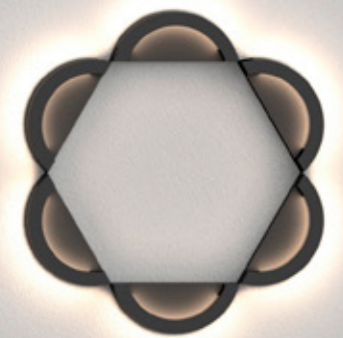

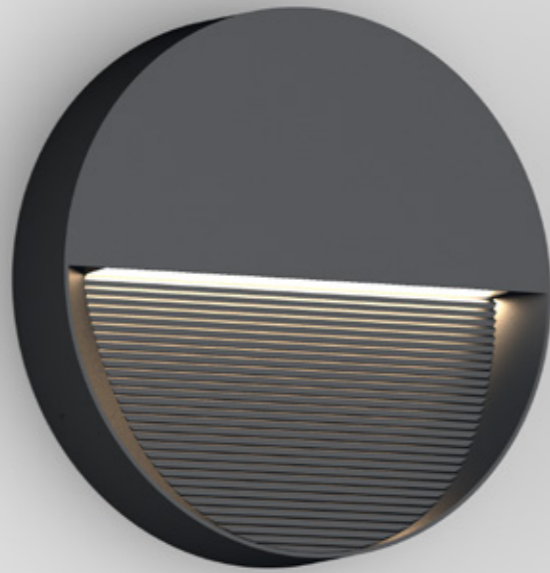

WL59 Exterior wall light

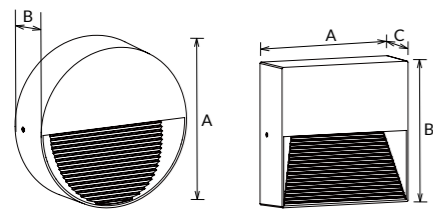

WL59 is an IP65 surface mounted wall light, the shell is made of high-strength aluminum alloy and making the protection level reach IK08 and UV resistant, the appearance of this series product is designed in a minimalist style. Simple square and circular lines combined with indirection LED light source can create a beautiful and soft lighting environment. The wall light can be used both in indoor and outdoor installation environments.

- ▶ 60° 70°
- ▶
- ▶
- ▶

Code	Watt	Size(AxBxCmm)	Lumen(±5%)	N.W/pc(kgs)	Q'ty/CTN
WL59A-5W	5W	Ø114x37	170lm	0.33	36PCS
WL59A-8W	8W	Ø180x35	320lm	0.62	24PCS
WL59B-5W	5W	114x114x37	170lm	0.39	36PCS
WL59B-8W	8W	180x180x35	320lm	0.74	24PCS
WL59C-5W	5W	114x180x35	170lm	0.53	12PCS
WL59C-10W	10W	114x250x35	450lm	0.75	12PCS

CCT 3000K 4000K 5000K 5700K

Finish White Black

WL60 Exterior step light

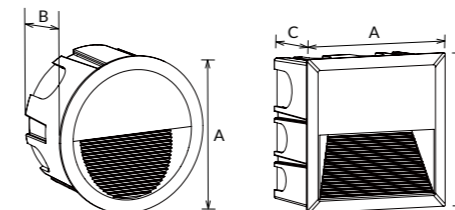

WL60 is an IP65 recessed wall light, the shell is made of high-strength aluminum alloy and making the protection level reach IK08 and UV resistant, the appearance of this series product is designed in a minimalist style. Simple square and circular lines combined with indirection LED light source can create a beautiful and soft lighting environment. The wall light can be used both in indoor and outdoor installation environments.

- ▶ 60° 70°
- ▶
- ▶
- ▶

Code	Watt	Size(AxBxCmm)	Cut-out(mm)	Lumen(±5%)	N.W/pc(kgs)	Q'ty/CTN
WL60A-5W	5W	Ø135x78	Ø130X78	170lm	0.38	18PCS
WL60A-8W	8W	Ø202x78	Ø196X78	320lm	0.71	6PCS
WL60B-5W	5W	136x136x78	130X130X78	170lm	0.45	18PCS
WL60B-8W	8W	201x201x78	195X195X78	320lm	0.85	6PCS
WL60C-5W	5W	136x202x78	130X196X78	170lm	0.61	12PCS
WL60C-10W	10W	271x135x78	266X130X78	450lm	0.86	12PCS

CCT 3000K 4000K 5000K 5700K

Finish White Black



WL124 Exterior step light

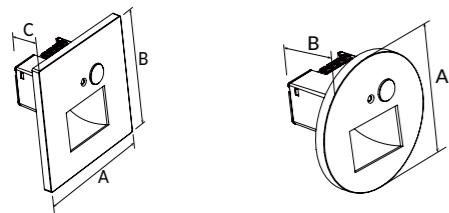

This is a compact design led step light for particularly use with cavity wall wiring boxes. Supplied with built-in driver and quick push terminal for easy and quick installation, it can also be loop in and loop out. One light body with 4 different clip on trim options and two light shapes to meet various requirements. It has daylight & PIR sensor function for energy saving and smarter lighting experiences. 3CCT adjustable via an integrated dip switch to save your stock SKU.

- ▶ 80° 90° IP44
- ▶ Flicker Free
- ▶ AC 200-240V CRI ≥ 80
- ▶ SAA RoHS CE

Code	Watt	Size(AxBxCmm)	Lumen(±5%)	N.W/pc(kgs)	Q'ty/CTN
WL124A-1W	1W	80x80x41	40lm	0.06	48PCS
WL124A-2W	2W	80x80x41	80lm	0.06	48PCS
WL124B-1W	1W	Ø80x41	40lm	0.06	48PCS
WL124B-2W	2W	Ø80x41	80lm	0.06	48PCS
ACC-WL124-WT-0300-01	-	80x80x6.2	-	0.011	80PCS
ACC-WL124-WT-0300-02	-	80x80x6.2	-	0.012	80PCS
ACC-WL124-WT-0300-03	-	Ø80x6.2	-	0.008	80PCS
ACC-WL124-WT-0300-04	-	Ø80x6.2	-	0.010	80PCS

CCT

3000K
4000K
5000K
5700K

Finish

White

WL92 Exterior wall light

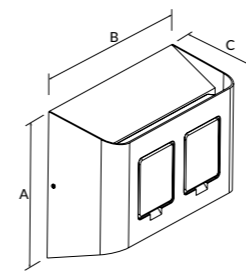

WL92 wall light is with direct & indirect lighting design, adjustable lighting direction by slide switch. It has two sockets which can feed power to some electric equipment, such as hair dryer, charger, mower, camera etc. which can provide users with much convenience.

- ▶ 100° 100° IP54
- ▶ DIM Flicker Free
- ▶ AC 220-240V PF ≥ 0.9 CRI ≥ 80
- ▶ SAA RoHS CE

Code	Watt	Size(AxBxCmm)	Lumen(±5%)	N.W/pc(kgs)	Q'ty/CTN
WL92-10W	2x5W(Unswitchable)/10W(Switchable)	220x152x82	620lm	1.3	12PCS

CCT

3000K
4000K
5000K
5700K

Finish

Black

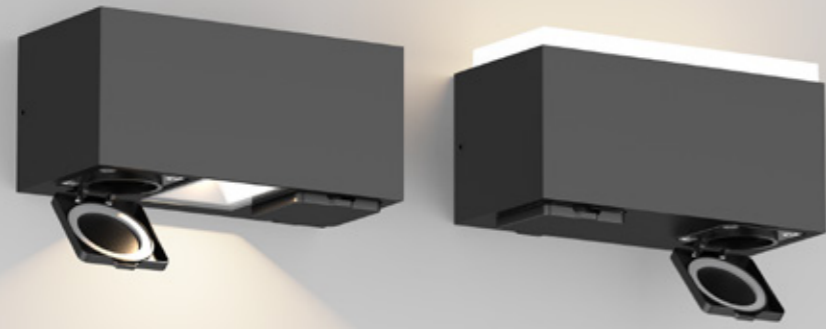

WL116 Exterior wall light

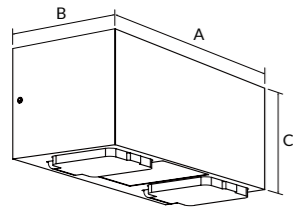

WL116A is an indirect lighting wall lamp with COB light source while WL116B is a direct lighting wall lamp with SMD light source, both types are IP54 waterproof and can be used in semi-outdoor applications. Both models are with two Europe standard sockets to support other equipment.

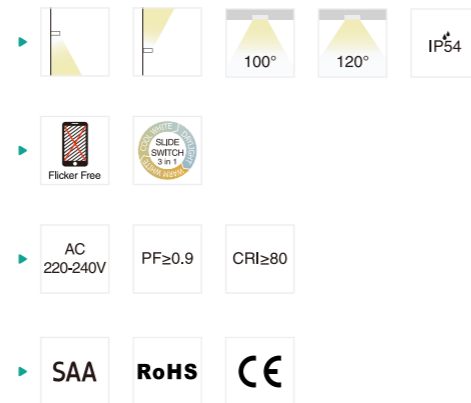

Code	Watt	Size(AxBxCmm)	Lumen(±5%)	N.W/pc(kgs)	Q'ty/CTN
WL116A-10W	10W	180x85x85	1200lm	0.92	18PCS
WL116B-10W	10W	180x96x85	980lm	0.83	18PCS

CCT — 3000K 4000K 5000K 5700K

Finish — Black



WL125 Exterior wall light

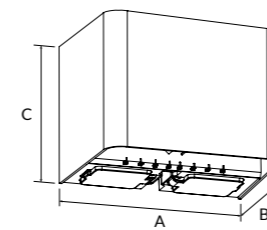

WL125a direct and indirect lighting wall lamp. It adopts Ra90 COB light source to make stronger and more real lighting decoration effect, 3CCT adjustable to meet more application demand. It can do 15 degree to 120 degree beam angle adjustment by shielding piece. To make a more convenient using experience, the lamp has two sockets which can feed power to some electric equipment, such as hair dryer, charger, mower, camera etc. ADC12 aluminium housing provides excellent thermal management, IP54 for both indoor and semi-outdoor application use.

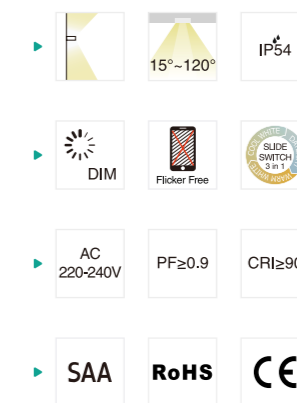

Code	Watt	Size(AxBxCmm)	Lumen(±5%)	N.W/pc(kgs)	Q'ty/CTN
WL125-8W-D	2x4W	165x130x123	560lm	1.35	12PCS
WL125-15W-P3	2x7.5W	165x130x123	950lm	1.35	12PCS

CCT — 2700K 3000K 4000K 5000K

Finish — Black



WL96 Series

PLUG-TYPE PIR SENSOR SECURITY



WL96 Exterior wall light

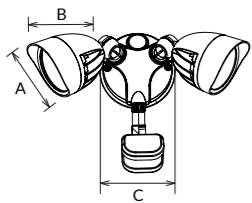

WL96 is an IP54 wall light with PIR sensor, which adopts high lumen COB light source and ADC12 aluminum. The lamp has a high lumen efficiency and great heat dissipation. Wall mounted and ceiling mounted options. Interchangeable CCT(3000K/5000K) is available. It's a great choice for outdoor walkways, garage areas, back door entrances etc.

- ▶ 100°
- ▶ IP65
- ▶ IP54
- ▶ Flicker Free
- ▶ 2 in 1
S.WITCH
PIR Sensor
- ▶ AC 220-240V
- ▶ PF≥0.9
- ▶ CRI≥80
- ▶ SAA
- ▶ RoHS
- ▶ CE

Code	Watt	Size(AxBxCmm)	Lumen(±5%)	N.W/pc(kgs)	Q'ty/CTN
WL96-12W-C3	12W	167x121x182	1200lm	0.48	24PCS
WL96-12W-S1C3	12W	167x121x182	1200lm	0.48	24PCS
WL96-24W-C3	2x12W	251x121x182	2400lm	0.58	24PCS
WL96-24W-S1C3	2x12W	251x121x182	2400lm	0.58	24PCS

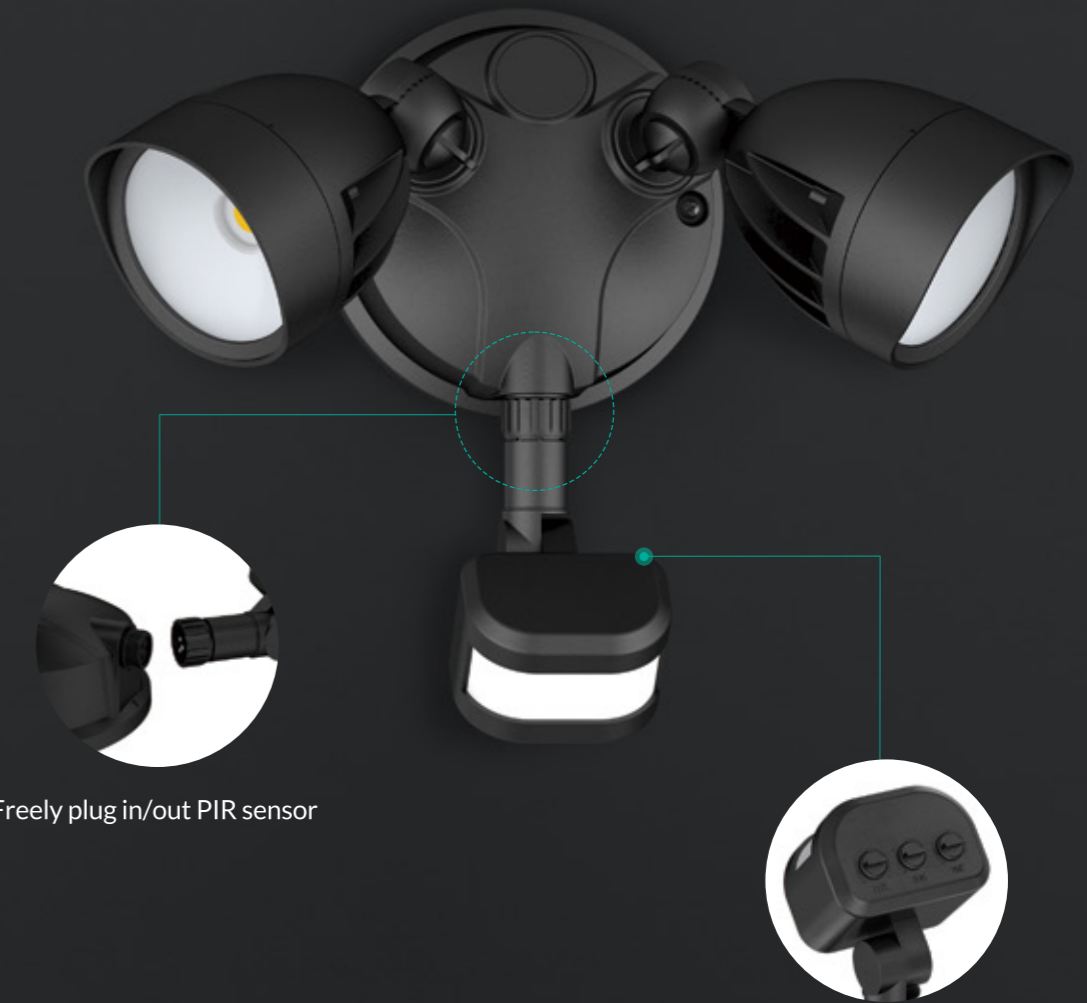

CCT ——— 3000K 4000K 5000K 5700K

Finish ——— Black



WL62 Exterior wall light

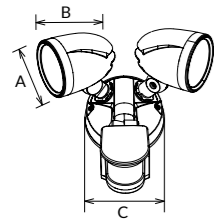

WL62 is an IP44 wall light with PIR sensor, it adopts high lumen COB light source and ADC12 aluminum. The lamp has high lumen efficiency and great heat dissipation. Wall mounted and ceiling mounted options. It's a great choice for outdoor walkways, garage areas, back door entrances etc.

- ▶ 90° IP65 IP54
- ▶ Flicker Free PIR Sensor
- ▶ AC 200-240V PF ≥ 0.5 CRI ≥ 80
- ▶ SAA RoHS CE

Code	Watt	Size(AxBxCmm)	Lumen(±5%)	N.W/pc(kgs)	Q'ty/CTN
WL62-11W	11W	Ø76x96xØ121	1250lm	0.48	12PCS
WL62-12W-S	12W	Ø76x96xØ121	1250lm	0.58	12PCS
WL62-23W	2x11.5W	Ø76x96xØ121	2350lm	0.75	12PCS
WL62-24W-S	2x12W	Ø76x96xØ121	2350lm	0.85	12PCS

CCT — 2700K 3000K 4000K 5000K

Finish — White Black



WL01 Exterior wall light

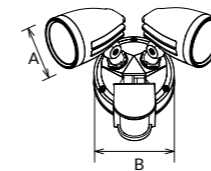

WL01 is a traditional Wall light with internal driver, the lighting direction can be adjusted accordingly, single head and multi-heads are both available. Sensor function optional, IP65 (IP54 for sensor function) suitable for a variety of applications.

- ▶ 90° IP65 IP54
- ▶ Flicker Free PIR Sensor
- ▶ AC 100-240V PF ≥ 0.5 CRI ≥ 80
- ▶ SAA RoHS CE

Code	Watt	Size(AxBmm)	Lumen(±5%)	N.W/pc(kgs)	Q'ty/CTN
WL01-8W	8W	Ø76xØ133	760lm	0.70	12PCS
WL01-13W	13W	Ø76xØ133	1145lm	0.58	12PCS
WL01-16W	16W	Ø76xØ133	1520lm	0.94	12PCS
WL01-26W	26W	Ø76xØ133	2240lm	0.94	12PCS

CCT — 3000K 4000K 5000K 5700K

Finish — Black



ML06 Spike light

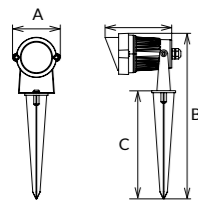

ML06 LED Spike light adopts aluminum body and plastic spike for damp conditions. The AC/DC12V input provides more safety guarantee. IP65 for outdoor use, it applies to landscaping embellishment lighting for residence and community and all kind of parks.

- ▶ 60°
- ▶
- ▶
- ▶

Code	Watt	Size(AxBxCmm)	Lumen(±5%)	N.W/pc(kgs)	Q'ty/CTN
ML06-6W	6W	Ø72x243x97	360lm	0.24	50PCS

CCT ——— 3000K 4000K 5000K 5700K

Finish ——— Black



ML07 Spike light

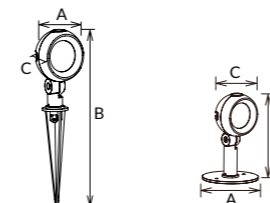

ML07A ML07B

ML07 LED Spike light adopts integrated SMD light source of fashion design, equipped with high lumen, high CRI, low temperature and long lifespan. Built-in driver, the AC/DC12V input provides more safety guarantee. IP65 for outdoor use, it applies to landscaping embellishment lighting for residence and community and all kind of parks.

- ▶ 36° 60°
- ▶
- ▶
- ▶

Code	Watt	Size(AxBxCmm)	Lumen(±5%)	N.W/pc(kgs)	Q'ty/CTN
ML07-6W	6W	Ø76x262x57.5	550lm	0.31	50PCS
ML07-10W	10W	Ø76x262x57.5	950lm	0.31	50PCS
ML07B-6W	6W	Ø100x156xØ76	550lm	0.40	24PCS
ML07B-10W	10W	Ø100x156xØ76	950lm	0.40	24PCS

CCT ——— 3000K 4000K 5000K 5700K

Finish ——— Black



NL14 Spike light

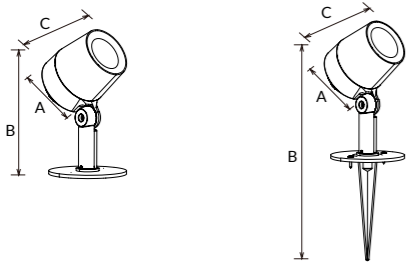

NL14 LED spike light is derived from the aircraft engine design. ADC12 aluminum lamp body provides strong heat dissipation. AC220V and AC/DC12V with ground install and board install option. Type A/B/E/F are isolated driver while Type C/D/G/H are non-isolated driver. IP65 waterproof and flicker free are available.

- ▶ 45° 60° IP65
- ▶ Flicker Free
- ▶

AC 220-240V	AC/DC 12V	PF≥0.9	CRI≥80
-------------	-----------	--------	--------
- ▶

SAA	RoHS	CE
-----	------	----

Code	Watt	Size(AxBxCmm)	Lumen(±5%)	N.W/pc(kgs)	Q'ty/CTN
NL14A-8W	8W	80x104x308.5	910lm	0.37	24PCS
NL14B-8W	8W	80x104x167.5	910lm	0.39	24PCS
NL14C-8W	8W	80x104x308.5	910lm	0.37	24PCS
NL14D-8W	8W	80x104x167.5	910lm	0.39	24PCS
NL14E-8W	8W	80x143x308.5	910lm	0.38	24PCS
NL14F-8W	8W	80x143x167.5	910lm	0.39	24PCS
NL14G-8W	8W	80x143x308.5	910lm	0.38	24PCS
NL14H-8W	8W	80x143x167.5	910lm	0.39	24PCS

CCT ——— 3000K 4000K 5000K 5700K

Finish ——— White Black

NL14 Series



AlanoD reflector

Aircraft engine design



NL14A-8W AC 220V NL14B-8W AC 220V NL14C-8W AC 220V NL14D-8W AC 220V NL14E-8W AC 220V NL14F-8W AC 220V NL14G-8W AC/DC 12V NL14H-8W AC/DC 12V



Asymmetric light distribution

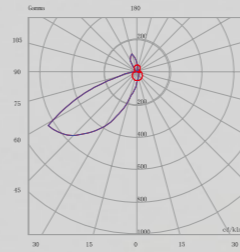

NL08 Garden light

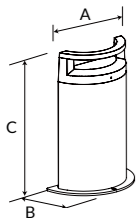

NL08 LED garden light won 2020 IF Award, adopting high lumen SMD, aluminum body with great thermal management. It is IP65 IK08 high protection. Indirect lighting design offers a great visual experience. Special shape design provides charming light spot. Size 500mm and 1000mm for options.

- ▶ 50° IP65 IK08
- ▶ Flicker Free
- ▶ AC 200-240V PF≥0.9 CRI≥80
- ▶ SAA RoHS CE



Code	Watt	Size(AxBxCmm)	Lumen(±5%)	N.W/pc(kgs)	Q'ty/CTN
NL08A-10W	10W	249x121x500	530lm	2.34	6PCS
NL08B-10W	10W	249x121x1000	530lm	4.03	2PCS

CCT ——— 3000K — 4000K — 5000K — 5700K

Finish ——— White Black

Lamp bollard ——— ACC-NL08B-00 ACC-NL08A-00 ACC-NL08-00

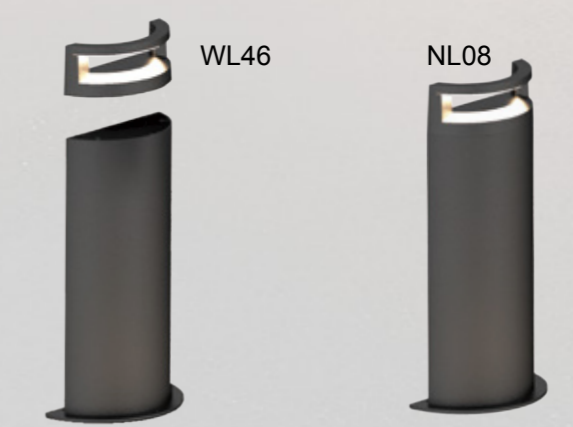



WL102 Interior wall light

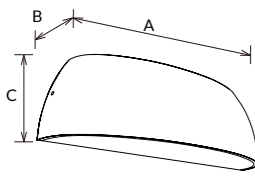

WL102 wall lamp is an up & down lighting design, the lamp body is made of aluminum die-casting, it adopts SMD light source, IP20, IK06 protection class. Single color temperature or tri-CCT changeable for options.

- ▶ 120° IP20
- ▶ DIM Flicker Free SLIDE SWITCH 3 in 1
- ▶ AC 220-240V PF≥0.9 CRI≥80
- ▶ SAA RoHS CE

Code	Watt	Size(AxBxCmm)	Lumen(±5%)	N.W/pc(kgs)	Q'ty/CTN
WL102-8W	4.8W+3.2W	242x67x67	770lm	0.60	24PCS

CCT — 3000K 4000K 5000K 5700K

Finish — White Black



WL146 Interior wall light

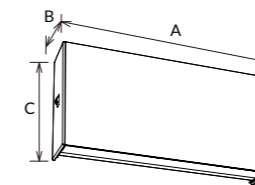

WL146 wall lamp is an ultra-thin design which has multiple lengths options. It adopts high lumen SMD light, wall-washing design for optical effect, so it can do higher and further lighting. The AL6063 Aluminium structure have a great heat dissipation. It's nice up and down lighting design which can achieve a better atmosphere. Quick install with male plug+female plug, fast connector, which makes easier installation and maintenance.

- ▶ 40° IP20
- ▶ DIM Flicker Free
- ▶ AC 220-240V PF≥0.85 CRI≥80
- ▶ SAA RoHS CE



Code	Watt	Size(AxBxCmm)	Lumen(±5%)	N.W/pc(kgs)	Q'ty/CTN
WL146-180-8W	2x4W	180x38.5x90	1000lm	0.50	12PCS
WL146-240-10W	2x5W	240x38.5x90	1200lm	0.65	12PCS
WL146-360-16W	2x8W	360x38.5x90	1900lm	0.90	12PCS
WL146-600-20W	2x10W	600x38.5x90	2300lm	1.23	12PCS

CCT — 3000K 4000K 5000K

Finish — White Black Wood grain



WL99 Interior wall light

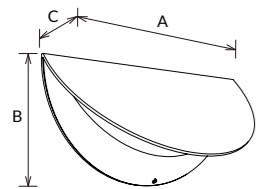

WL99 LED wall light with very special shape. IP20 and single color temperature are available. AC230V dimmable version and AC 110-240V non-dimmable version for options.

- ▶ 120° IP20
- ▶ Flicker Free
- ▶ AC 110-240V PF≥0.9 CRI≥80
- ▶ SAA RoHS CE

Code	Watt	Size(AxBxCmm)	Lumen(±5%)	N.W/pc(kgs)	Q'ty/CTN
WL99-10W	10W	205x103x75	500lm	0.40	24PCS
WL99-10W-D	10W	205x103x75	500lm	0.40	24PCS

CCT — 3000K 4000K 5000K 5700K

Finish — White Black

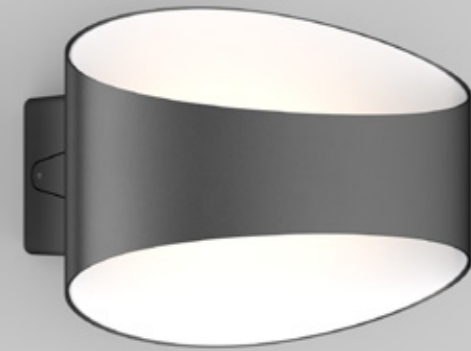

WL95 Interior wall light

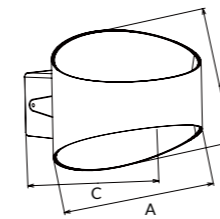

WL95 is an indoor oval shape up & down wall lamp with built-in driver. It adopts high lumen SMD light source, ADC12 aluminum housing offers a great thermal management and PC reflector can be customized in different colors(Standard color is white)..Interchangeable CCT with slide switch is available.

- ▶ 360° IP20
- ▶ DIM Flicker Free SLIDE SWITCH 2 in 1
- ▶ AC 220-240V PF≥0.9 CRI≥80
- ▶ SAA RoHS CE

Code	Watt	Size(AxBxCmm)	Lumen(±5%)	N.W/pc(kgs)	Q'ty/CTN
WL95-8W-C2	8W	200x140x107	435lm	0.52	24PCS
WL95-8W-P2	8W	200x140x107	425lm	0.52	24PCS

CCT — 3000K 4000K 5000K 5700K

Finish — White Black

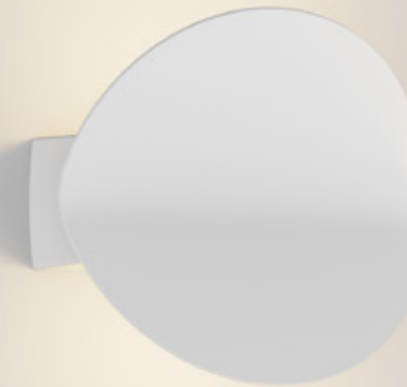
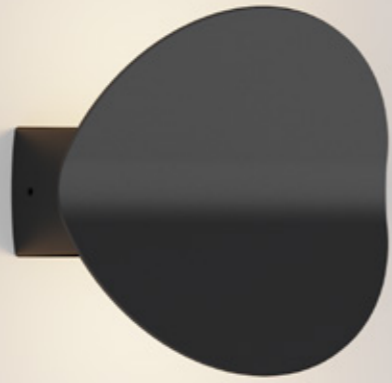

WL106 Interior wall light

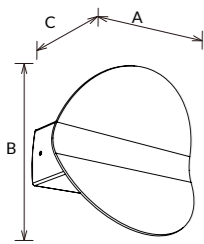

WL106 led wall light impresses with its unique design, 160-degree beam angle lighting up the wall. The built-in terminal block makes installation and maintenance more convenient. Adopt high lumen SMD LED light source with CCT changeable available. Aluminum body with great thermal management.

- ▶ 160° IP20
- ▶ DIM Flicker Free 3 in 1
- ▶ AC 220-240V PF ≥ 0.9 CRI ≥ 80
- ▶ SAA RoHS CE

Code	Watt	Size(AxBxCmm)	Lumen(±5%)	N.W/pc(kgs)	Q'ty/CTN
WL106-8W	2x4W	145x135x80	730lm	0.36	24PCS

CCT ——— 3000K 4000K 5000K 5700K

Finish ——— White Black

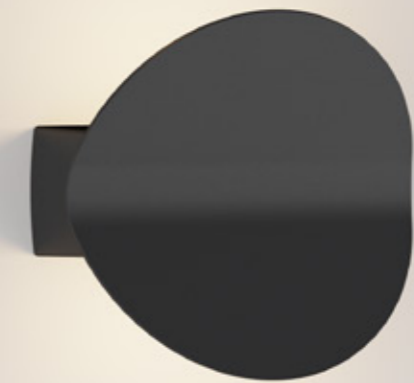

Sprout Design



3CCT changeable

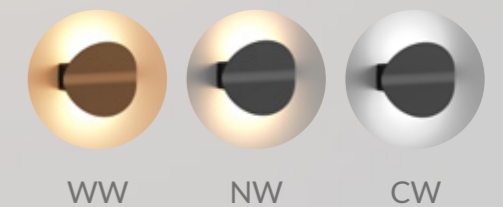

WL101 SERIES

WL101 Interior wall light

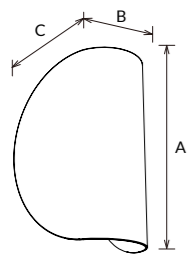

WL101 is a LED wall light with ADC12 aluminium lamp body and PC cover. The cover is rotatable 28 degree vertically, and lamp body rotatable 350 degree horizontally. Low UGR design provides soft lighting performance.

- ▶ 90° 350° 28° IP20
- ▶ Flicker Free
- ▶ AC 220-240V PF≥0.9 CRI≥80
- ▶ SAA RoHS CE

Code	Watt	Size(AxBxCmm)	Lumen(±5%)	N.W/pc(kgs)	Q'ty/CTN
WL101-8W	2x4W	170x105x101	700lm	0.68	24PCS

CCT ——— 3000K 4000K 5000K 5700K

Finish ——— White

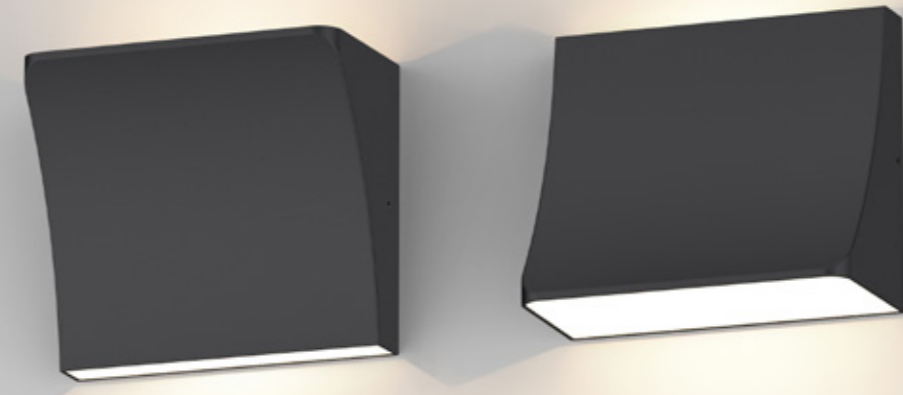

WL107 Interior wall light

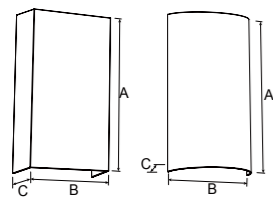

WL107 wall lamp has square shape (Type A) and semi-circle shape (Type B) options. It adopts high lumen SMD light source, frosted PC cover and wide beam angle lead a uniform light output for both up&downward. ADC12 aluminum lamp body provides a great thermal management.

- ▶ 100° IP20
- ▶ DIM Flicker Free SLIDE SWITCH 3 in 1
- ▶ AC 200-240V AC 100-240V PF≥0.9 CRI≥80
- ▶ SAA RoHS CE

Code	Watt	Size(AxBxCmm)	Lumen(±5%)	N.W/pc(kgs)	Q'ty/CTN
WL107A-5W	2x2.5W	150x85x43	720lm	0.31	24PCS
WL107A-8W	2x4W	150x85x43	940lm	0.31	24PCS
WL107B-5W	2x2.5W	150x85x43	720lm	0.31	24PCS
WL107B-8W	2x4W	150x85x43	940lm	0.31	24PCS

CCT — 3000K 4000K 5000K 5700K

Finish — White Black

WL117 Interior wall light

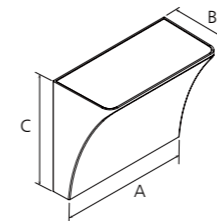

WL117 is a wave shape wall lamp, its streamlined shape fits the wall well and makes the space clean and tidy. Direct & indirect lighting design offers a great decorative effect. Besides, it can adjust CCT to meet different application areas demand, ADC12 aluminum housing providing excellent thermal management.

- ▶ 110° IP20
- ▶ DIM Flicker Free SLIDE SWITCH 3 in 1
- ▶ AC 220-240V PF≥0.88 CRI≥80
- ▶ SAA RoHS CE

Code	Watt	Size(AxBxCmm)	Lumen(±5%)	N.W/pc(kgs)	Q'ty/CTN
WL117-8W	5.5W(Indirect)+2.5W(Direct)	140x70x120	700lm	0.48	24PCS

CCT — 3000K 4000K 5000K 5700K

Finish — White Black Grey Silver

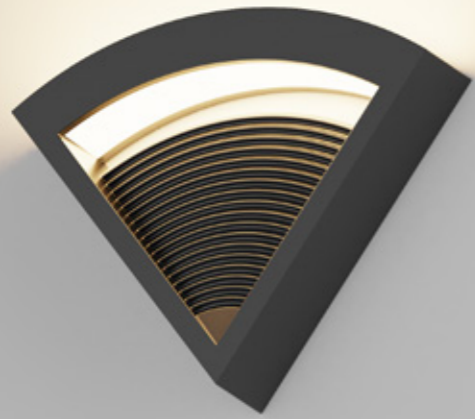

WL173 Interior wall light

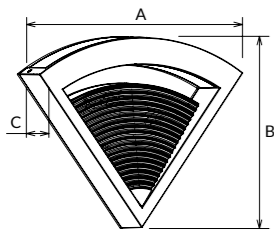

WL173 LED wall light with internal flicker free driver design. DIY combination can form different patterns according to personal preferences. It adopts ADC12 aluminium housing for a good heat management. Interchangeable CCT (2700K+3500K+5000K) and triac dim are available.

- ▶ 120° IP20
- ▶ DIM Flicker Free SLIDE SWITCH 3 in 1
- ▶ AC 220-240V PF ≥ 0.88 CRI ≥ 80
- ▶ SAA RoHS CE

Code	Watt	Size(AxBxCmm)	Lumen(±5%)	N.W/pc(kgs)	Q'ty/CTN
WL173-8W-D	8W	200x170x45	420lm	0.42	24PCS

CCT — 2700K 3000K 4000K 5000K

Finish — White Black



WL122 Interior wall light

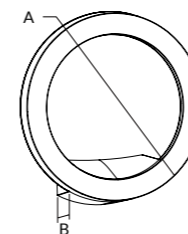

WL122 LED wall light is a scene lighting design with backward atmosphere light. It adopts SMD light source, aluminium housing provides great thermal management to ensure a long lifespan. The cambered milky lampshade increases the lighting range, through secondary reflection, it reduces direct glare and makes a comfortable visual experience.

- ▶ 120° IP40
- ▶ Flicker Free
- ▶ AC 100-240V PF ≥ 0.9 CRI ≥ 80
- ▶ SAA RoHS CE

Code	Watt	Size(AxBmm)	Lumen(±5%)	N.W/pc(kgs)	Q'ty/CTN
WL122-8W	8W	Ø195x54	870lm	0.33	24PCS

CCT — 3000K 4000K 5000K 5700K

Finish — White Black



WL126 Interior wall light

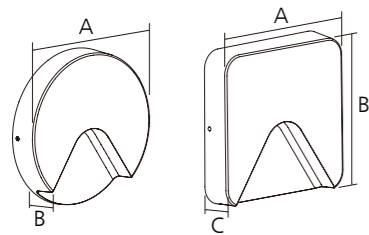

WL126 LED wall light is super thin 26mm thickness for indoor application. It adopts high lumen SMD chip and ADC12 aluminum housing. Interchangeable CCT(2700K+4000K) is available. Round and square outlook for options.

- ▶ 60° IP20
- ▶ Flicker Free SLIDE SWITCH 3 in 1
- ▶ AC 220-240V PF≥0.4 CRI≥80
- ▶ SAA RoHS CE

Code	Watt	Size(AxBmm)	Lumen(±5%)	N.W/pc(kgs)	Q'ty/CTN
WL126A-3W	3W	Ø135x26	98lm(Black)/155lm(White)	0.26	48PCS
WL126B-3W	3W	135x135x26	90lm(Black)/155lm(White)	0.31	48PCS

CCT ——— 2700K ——— 3000K ——— 4000K

Finish ——— White Black



WL141 NEW Interior wall light

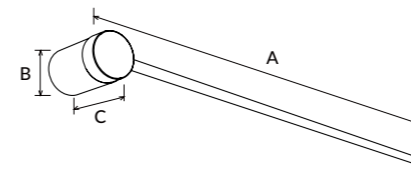

WL141 Wall light is a backlit and rotate 360° directions design, aluminum body provide simply and texture experience, multiple installation ceiling mounted and wall mounted available. DIY combination can form different patterns according to personal preferences, adjustable CCT and single/double head makes it more possibility for different lighting applications.

- ▶ 120° IP20
- ▶ Flicker Free SLIDE SWITCH 3 in 1
- ▶ AC 220-240V PF≥0.85 PF≥0.9 CRI≥80 CRI≥90
- ▶ SAA RoHS CE

Code	Watt	Size(AxBxCmm)	Lumen(±5%)	N.W/pc(kgs)	Q'ty/CTN
WL141A-12W	12W	600x70x109	1170lm	0.41	12PCS
WL141A-15W	15W	900x70x109	1550lm	0.45	12PCS
WL141A-20W	20W	1200x70x109	2100lm	0.60	12PCS
WL141B-12W	12W	600x70x109	1170lm	0.41	12PCS
WL141B-15W	15W	900x70x109	1550lm	0.45	12PCS
WL141B-20W	20W	1200x70x109	2100lm	0.60	12PCS

CCT ——— 3000K ——— 4000K ——— 5000K ——— 5700K

Finish ——— Black

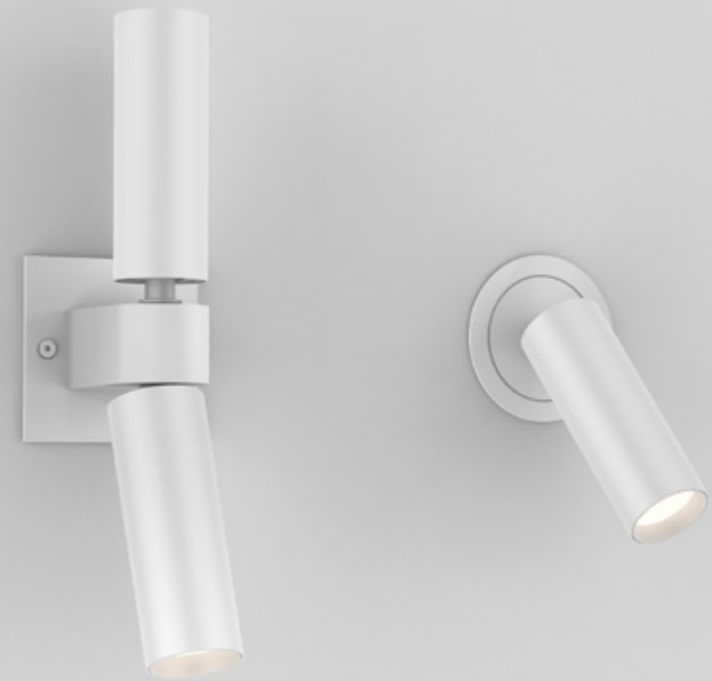
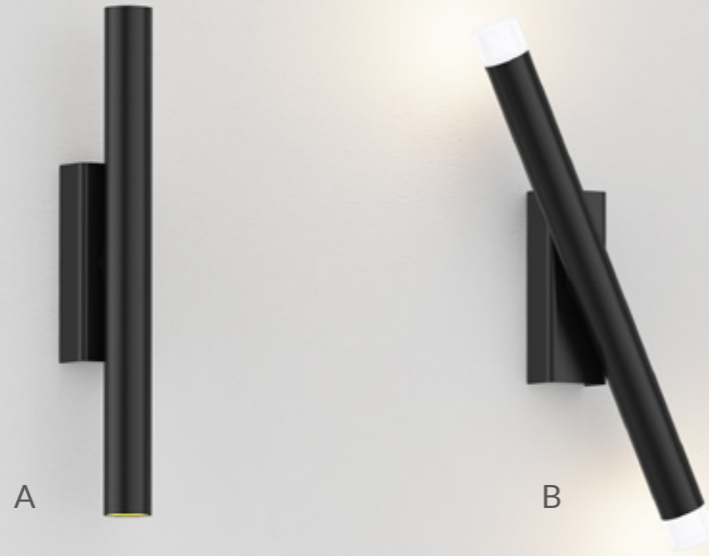

WL134 NEW Interior wall light

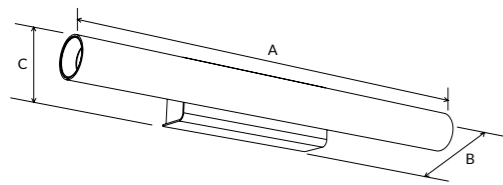

WL134 is a long cylinder wall lamp with up and down lighting, which support 350 degree rotation for lighting decoration. It adopts aluminum housing, and has milky diffuser & gold/silver trim version optional.

- ▶ 20° 40° 350° IP20
- ▶ Flicker Free
- ▶ AC 220-240V CRI ≥ 80
- ▶ SAA RoHS CE

Code	Watt	Size(AxBxCmm)	Lumen(±5%)	N.W/pc(kgs)	Q'ty/CTN
WL134A-4W	4W	320x61x46	510lm	0.45	24PCS
WL134B-4W	4W	364x61x46	450lm	0.46	24PCS

CCT 3000K 4000K 5000K 5700K

Finish White Black

WL100 Interior wall light

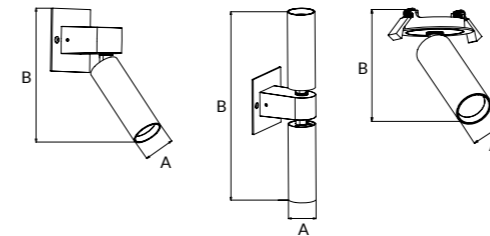

WL100 is LED mini wall light with build-in driver design for indoor application. It adopts AL6063 aluminum housing to ensure a good thermal management and brand CITIZEN COB with high lumen efficiency. The lamp body can be rotated 60° vertically and 200° horizontally. Wall mounted and recessed are available. Three beam angle: 24°/36°/60° for options.

- ▶ 24° 36° 60° IP20 UGR < 19
- ▶ DIM Flicker Free
- ▶ AC 220-240V PF ≥ 0.9 CRI ≥ 80
- ▶ SAA RoHS CE

Code	Watt	Size(AxBmm)	Cut-out(mm)	Lumen(±5%)	N.W/pc(kgs)	Q'ty/CTN
WL100A-5W-D	5W	Ø39x181	-	600lm	0.35	24PCS
WL100B-10W-D	5W+5W	Ø39x283	-	1100lm	0.50	24PCS
WL100C-5W-D	5W	Ø39x148	Ø68-Ø75	600lm	0.22	24PCS

CCT 2700K 3000K 4000K 5000K

Finish White Black



WL109 Interior wall light

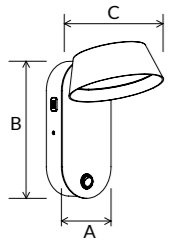

WL109 is an indoor wall lamp which has 180degrees rotation for a flexible adjustment. It is a compact design with milky PC shade, so that it can has a soft and uniform light output. Besides, it adopt high lumen efficiency SMD light source, can offer enough lighting for users. ADC12 aluminum housing provides a great thermal management, ensures a longer lifespan.

- ▶ 100°
- ▶ 180°
- ▶ IP20
- ▶ DIM
- ▶ Flicker Free
- ▶ SLIDE SWITCH 3 in 1
- ▶ AC 200-240V
- ▶ PF≥0.85
- ▶ CRI≥80
- ▶ SAA
- ▶ RoHS
- ▶ CE

Code	Watt	Size(AxBxCmm)	Lumen(±5%)	N.W/pc(kgs)	Q'ty/CTN
WL109-4W	4W	132x69x152	550lm	0.36	12PCS

CCT — 3000K 4000K 5000K 5700K

Finish — White Black



WL136 NEW Interior wall light

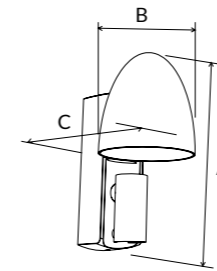

WL136 is a small mushroom appearance design with rotated lighting angle, which has magnetic switch control light on/off, and can work as reading lamp or night lamp.

- ▶ 45°
- ▶ IP20
- ▶ Flicker Free
- ▶ AC 220-240V
- ▶ PF≥0.7
- ▶ CRI≥80
- ▶ SAA
- ▶ RoHS
- ▶ CE

Code	Watt	Size(AxBxCmm)	Lumen(±5%)	N.W/pc(kgs)	Q'ty/CTN
WL136-3W	3W	216x105x138	250lm	0.44	12PCS

CCT — 2700K 3000K 4000K 5000K

Finish — White Black



WL127 Interior wall light

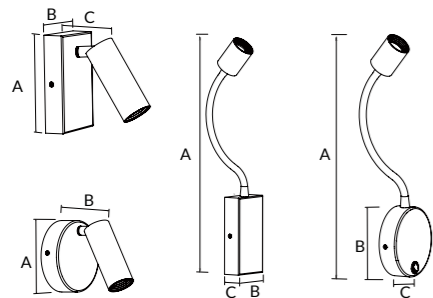

WL127 LED bed light with round and square shape, short neck and goose neck(AC switch optional). It adopts SMD led chip with special lens for soft lighting effect. AL6063 aluminium housing provides excellent thermal management. Internal flicker free driver design is available.

- ▶ 50° IP20
- ▶ DIM Flicker Free
- ▶ AC 220-240V PF≥0.4 CRI≥80
- ▶ SAA RoHS CE

Code	Watt	Size(AxBxCmm)	Lumen(±5%)	N.W/pc(kgs)	Q'ty/CTN
WL127A-3W	3W	115x63x71	260lm	0.27	24PCS
WL127B-3W	3W	364x63x27	260lm	0.28	24PCS
WL127C-3W	3W	∅95x71	260lm	0.25	24PCS
WL127D-3W	3W	344x95x27	260lm	0.27	24PCS

CCT ——— 2700K 3000K 4000K 5000K Finish ——— White

WL135 NEW Interior wall light

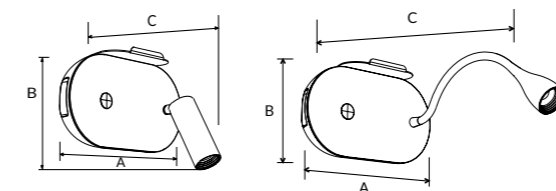

WL135 is a bedside lamp with short gyro neck or goose neck design, which supports touch switch and USB&Type-C charge. It adopts aluminium housing and SMD led chip with special lens, which ensures excellent thermal management and soft lighting effect.

- ▶ 50° IP20
- ▶ Flicker Free
- ▶ AC 220-240V PF≥0.9 CRI≥80
- ▶ SAA RoHS CE

Code	Watt	Size(AxBxCmm)	Lumen(±5%)	N.W/pc(kgs)	Q'ty/CTN
WL135A-3W-T	17W	200x138x79	280lm	0.49	12PCS
WL135B-3W-T	17W	200x115x304	280lm	0.52	12PCS

CCT ——— 2700K 3000K 4000K 5000K Finish ——— White

Accessory ——— ACC-WL135-WT-0000

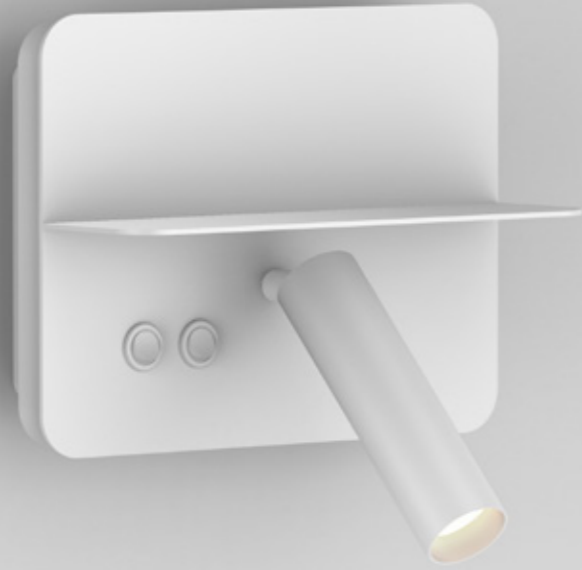

WL68 Interior wall light

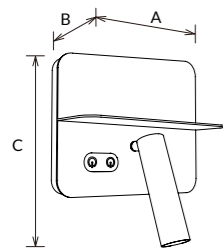

WL68 is a bedside lamp with phone shelf. There has two lighting part, CREE COB light source for front part, SMD2835 light source for back part. It has touch switch and rocker switch versions, both versions have two switches for front and back light part. For touch switch version, there has USB interface in left and right side, brightness can be adjusted with long press. Rocker switch version has no USB interface, no dim function.

- ▶ 36° IP40
- ▶ Flicker Free
- ▶ AC 200-240V PF ≥ 0.9 CRI ≥ 80 CRI ≥ 90
- ▶ SAA RoHS CE

Code	Watt	Size(AxBxCmm)	Lumen(±5%)	N.W/pc(kgs)	Q'ty/CTN
WL68-9W	4.5W+4.5W	200x94.8x202	350lm/300lm	0.66	12PCS
WL68-9W-T	4.5W+4.5W	200x94.8x202	350lm/300lm	0.66	12PCS

CCT — 2700K 3000K 4000K 5000K

Finish — White Black

WL69 Interior wall light

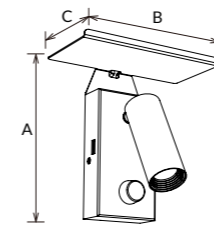

WL69 is a bedside lamp with compact design and switch knob dimming. It adopts SMD led chip with special lens which make a comfortable visual experience. With USB charging function, mobile phone shelf bracket as option, it make your life more convenience.

- ▶ 36° IP20
- ▶ Flicker Free
- ▶ AC 220-240V PF ≥ 0.9 CRI ≥ 80
- ▶ SAA RoHS CE

Code	Watt	Size(AxBxCmm)	Lumen(±5%)	N.W/pc(kgs)	Q'ty/CTN
WL69A-5W-D	5W	161x150x81	420lm	0.62	24PCS
WL69B-5W-D	5W	161x150x341	420lm	0.68	24PCS

CCT — 3000K 4000K 5000K 5700K

Finish — White Black

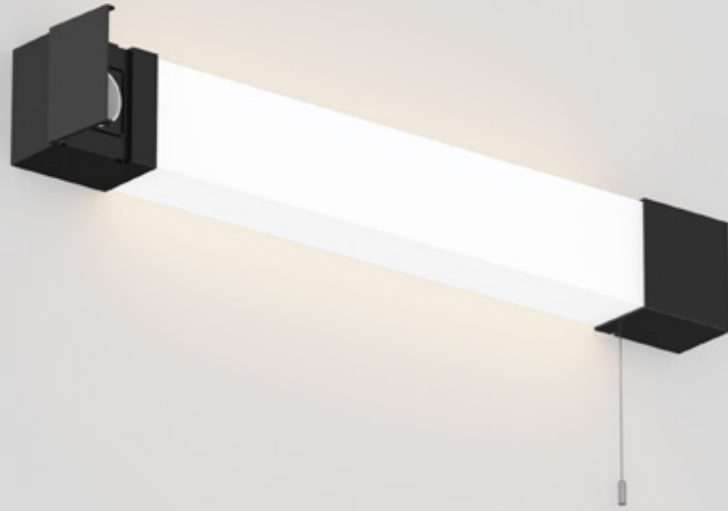

ML25 Mirror light

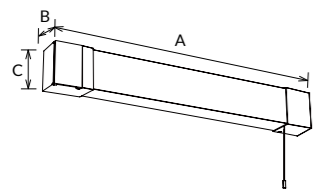

ML25 LED mirror light with wide beam angle 140 degree. PC diffuser provides a uniform light output. EU socket is in end cap which can connect 16A high-power electrical device like hair dryer. IP44 waterproof design, separated pull switch and CCT changeable are available.

- ▶ 140°
- ▶
- ▶
- ▶

Code	Watt	Size(AxBxCmm)	Lumen(±5%)	N.W/pc(kgs)	Q'ty/CTN
ML25-600-8W	8W	599x57x85	850lm	0.74	12PCS
ML25-900-10W	10W	899x57x85	1150lm	1.02	12PCS

CCT

3000K
4000K
5700K

Finish

White
Silver

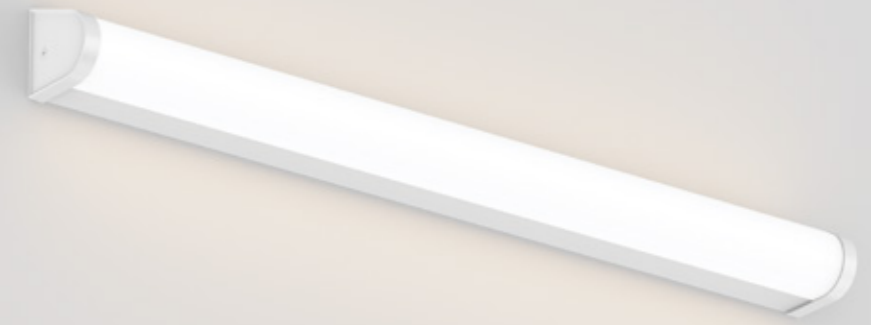

ML26 Mirror light NEW

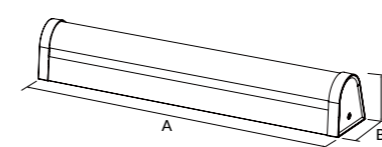

ML26 LED mirror light is with IP44 waterproof. It adopts high lumen SMD light source 130lm/W and milky shade mitigates the glare. Type B with EU socket which can hold 16A electrical device. And triac dim, adjustable CCT, PIR sensor are available.

- ▶ 175°x110°
- ▶
- ▶
- ▶

Code	Watt	Size(AxBxCmm)	Lumen(±5%)	N.W/pc(kgs)	Q'ty/CTN
ML26A-450-5W	5W	450x80x80	700lm	0.63	12PCS
ML26A-555-8W	8W	555x80x80	1200lm	0.74	12PCS
ML26A-555-10W	10W	555x80x80	1400lm	0.74	12PCS
ML26A-855-8W	8W	855x80x80	1200lm	1.05	12PCS
ML26A-855-12W	12W	855x80x80	1700lm	1.05	12PCS
ML26B-495-5W	5W	495x80x80	700lm	0.75	12PCS
ML26B-600-8W	8W	600x80x80	1200lm	0.85	12PCS
ML26B-600-10W	10W	600x80x80	1400lm	0.85	12PCS
ML26B-900-8W	8W	900x80x80	1200lm	1.20	12PCS
ML26B-900-12W	12W	900x80x80	1700lm	1.20	12PCS

CCT

3000K
4000K
5000K
5700K

Finish

White



ML34 NEW Mirror light

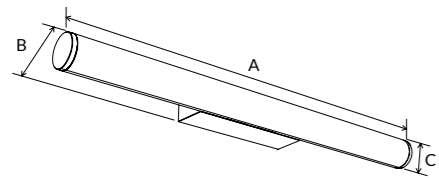

ML34 is an IP44 waterproof level modern design in minimalist style, adopting high lumen SMD LED and high transmittance PC lamp shade. 130LM/W high lumen efficiency, Interchangeable 2CCT or 3CCT with slide switch.

- ▶ 160°
- ▶
- ▶
- ▶

Code	Watt	Size(AxBxCmm)	Lumen(±5%)	N.W/pc(kgs)	Q'ty/CTN
ML34-450-6W	6W	450x80x46	830lm	0.49	12PCS
ML34-600-8W	8W	600x80x46	1200lm	0.59	12PCS
ML34-600-10W	10W	600x80x46	1400lm	0.59	12PCS
ML34-900-12W	12W	900x80x46	1650lm	0.80	12PCS
ML34-900-15W	15W	900x80x46	2100lm	0.80	12PCS

CCT

3000K
4000K
5000K
5700K
Finish

White
Chrome
Golden



ML35 NEW Mirror light

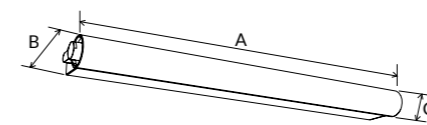

ML35 not only has mimicking frosted glass appearance texture but also adopts high efficiency LED, so that the whole lamp can provide a soft, uniform lighting. Easy disassembly and assembly; Interchangeable CCT with slide switch is available.

- ▶ 160°
- ▶
- ▶
- ▶

Code	Watt	Size(AxBxCmm)	Lumen(±5%)	N.W/pc(kgs)	Q'ty/CTN
ML35-600-8W	8W	600x79x46	1050lm	0.81	12PCS
ML35-600-12W	12W	600x79x46	1550lm	0.81	12PCS
ML35-900-12W	12W	900x79x46	1550lm	1.17	6PCS
ML35-900-15W	15W	900x79x46	1900lm	1.17	6PCS

CCT

3000K
4000K
5000K
5700K
Finish

White
Chrome

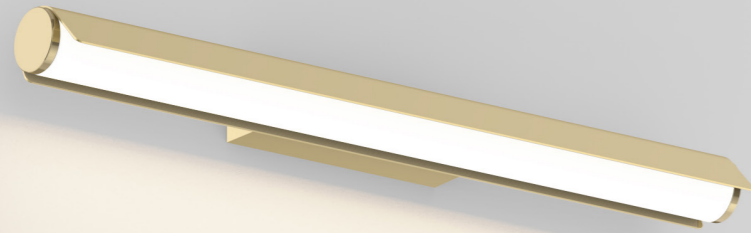

ML33 NEW Mirror light

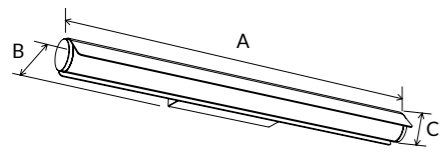

ML33 is a unique modern design in minimalist style, adopting high lumen efficiency led chip and high transmittance PC lamp shade. IP44 waterproof level and interchangeable CCT(3000K+4000K+5700K) with slide switch.

- ▶ 110°
- ▶
- ▶
- ▶

Code	Watt	Size(AxBxCmm)	Lumen(±5%)	N.W/pc(kgs)	Q'ty/CTN
ML33-450-6W	6W	450x107x51	600lm	0.69	12PCS
ML33-600-10W	10W	600x107x51	930lm	0.88	12PCS
ML33-600-12W	12W	600x107x51	1100lm	0.88	12PCS
ML33-900-12W	12W	900x107x51	1100lm	1.23	12PCS
ML33-900-15W	15W	900x107x51	1360lm	1.23	12PCS

CCT — 3000K 4000K 5000K 5700K

Finish — White Black



ML43 NEW Mirror light

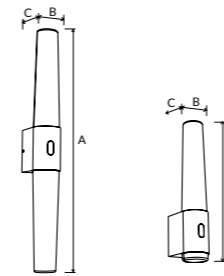

ML43 Mirror light is with touch dimmable design, PC housing with uniform light, Interchangeable CCT with slide switch is available, IP54 waterproof, IK06 Wall mounted in front of the bathroom mirror, create a better lighting condition for make-up or check your appearance.

- ▶ 360°
- ▶
- ▶
- ▶

Code	Watt	Size(AxBxCmm)	Lumen(±5%)	N.W/pc(kgs)	Q'ty/CTN
ML43A-15W-D	15W	590x85x100	1400lm	0.56	12PCS
ML43A-15W-P3	15W	590x85x100	1400lm	0.56	12PCS
ML43B-8W-D	8W	365x85x100	700lm	0.45	12PCS
ML43B-8W-P3	8W	365x85x100	700lm	0.45	12PCS

CCT — 2700K 3000K 4000K 5000K 5700K

Finish — White



ML15 Mirror light

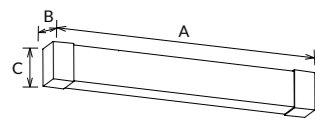

ML15 Mirror lamp has a wide beam angle, it adopts 2835 SMD high lumen light source to reach high efficiency, 120lm/W for standard version, 110lm/W for sensor version. PC diffuser provides a uniform light output. The whole lamp is IP44 IK06 protection level, dismountable design makes a more convenient installation. Interchangeable CCT (3000/4000/5700k) with slide switch and microwave sensor option can also make users has a great experience.

- ▶ 140°
- ▶
- ▶
- ▶

Code	Watt	Size(AxBxCmm)	Lumen(±5%)	N.W/pc(kgs)	Q'ty/CTN
ML15-450-8W	8W	450x58x85	880lm	0.58	12PCS
ML15-600-10W	10W	600x58x85	1200lm	0.71	12PCS

CCT — 3000K — 4000K — 5700K

Finish — White Black



ML13 Mirror light

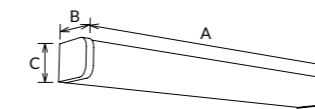

ML13 mirror light is an easy dismountable design, adopting high transmittance PC lampshade and high lumen SMD LED with 120lm/W, flicker free internal driver. Full PC material makes a lighter weight. Interchangeable CCT by slide switch and sensor function for 600mm/900mm is available, replaceable end cap with white, black or silver color options.

- ▶ 120°
- ▶
- ▶
- ▶

Code	Watt	Size(AxBxCmm)	Lumen(±5%)	N.W/pc(kgs)	Q'ty/CTN
ML13-480-8W	8W	480x77.5x61	1010lm	0.45	12PCS
ML13-600-10W	10W	600x77.5x61	1270lm	0.62	12PCS
ML13-900-15W	15W	900x77.5x61	1900lm	0.82	12PCS

CCT — 3000K — 4000K — 5000K — 5700K

Finish — White Black

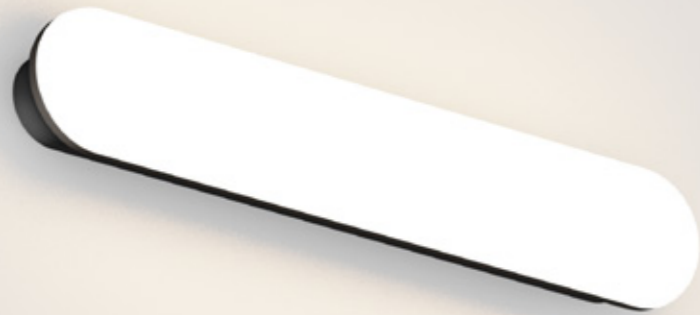

ML17 Mirror light

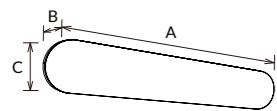

ML17 is a wall lamp which adopts anti-UV PC cover with uniform light output and high lumen SMD light source, 110lm/W. IP54 waterproof can be used in restroom. Interchangeable CCT with slide switch and microwave sensor are available. Button on side for On/Off, which makes a convenient operation.

- ▶ 120°
- ▶
- ▶
- ▶

Code	Watt	Size(AxBxCmm)	Lumen(±5%)	N.W/pc(kgs)	Q'ty/CTN
ML17-450-10W	10W	450x61x80	1100lm	0.78	12PCS
ML17-450-13W	13W	450x61x80	1420lm	0.78	12PCS

CCT ——— 3000K 4000K 5000K 5700K

Finish ——— White





ML27 Mirror light

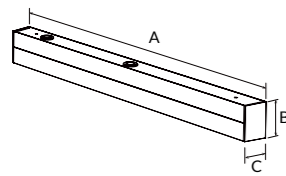

ML27 LED mirror light combines quick install with no screws on surface design. Aluminum lamp body offers great thermal management. It adopts high lumen SMD light source 120lm/W and high transmittance milk lamp shade. 3CCT changeable and DALI dimming features are available, 600mm/900mm/1200mm length for option. IP40 widely used for dresser room.

- ▶ 160°x110°
- ▶ IP40
- ▶ DALI
- ▶ Flicker Free
- ▶ SLIDE SWITCH 2 in 1
- ▶ AC 220-240V
- ▶ PF ≥ 0.9
- ▶ CRI ≥ 80
- ▶ SAA
- ▶ RoHS
- ▶ CE

Code	Watt	Size(AxBxCmm)	Lumen(±5%)	N.W/pc(kgs)	Q'ty/CTN
ML27-600-12W	12W	600x72x46	1600lm	1.00	6PCS
ML27-900-20W	20W	900x72x46	2600lm	1.30	6PCS
ML27-1200-32W	32W	1200x72x46	4000lm	1.60	6PCS

CCT ——— 3000K 4000K 5000K 5700K

Finish ——— White Black

Installation accessories ——— Suspension kit



ML30 NEW Mirror light

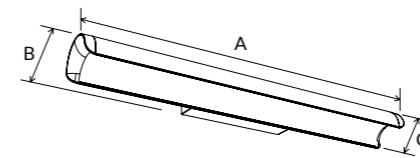

There is no direct light between the human eye and the luminous surface of ML30, which appearance with crescent design sense and milky white PC lamp shade. Interchangeable CCT with slide switch is available, IP40 for front side.

- ▶ 110°
- ▶ IP40
- ▶ Flicker Free
- ▶ SLIDE SWITCH 3 in 1
- ▶ AC 220-240V
- ▶ PF ≥ 0.9
- ▶ CRI ≥ 80
- ▶ SAA
- ▶ RoHS
- ▶ CE

Code	Watt	Size(AxBxCmm)	Lumen(±5%)	N.W/pc(kgs)	Q'ty/CTN
ML30-460-6W	6W	462x102x59	650lm	0.54	12PCS
ML30-580-10W	10W	580x102x59	1080lm	0.64	12PCS
ML30-850-15W	15W	847x102x59	1600lm	0.81	6PCS

CCT ——— 3000K 4000K 5000K 5700K

Finish ——— White Chrome

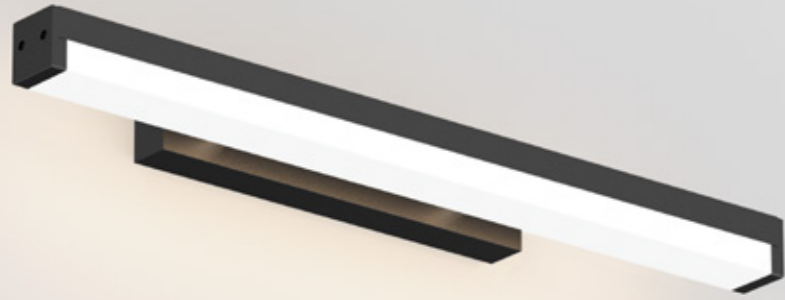

ML18 Mirror light

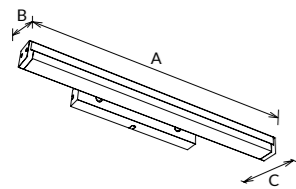

ML18 is a super design mirror light, it adopts high transmittance PC lampshade and AL6063 aluminum lamp body. High lumen SMD LED with 110lm/W light effect, be available of interchangeable CCT by slide switch. It's elegant design, perfect details to create a sense of stylish. Widely be used in Hotel, Shopping mall, home, restaurant, etc.

- ▶ 120° IP40
- ▶ Flicker Free SLIDE SWITCH 3 in 1
- ▶ AC 100-240V PF≥0.9 CRI≥80
- ▶ SAA RoHS CE

Code	Watt	Size(AxBxCmm)	Lumen(±5%)	N.W/pc(kgs)	Q'ty/CTN
ML18-580-10W	10W	580x50x111	1150lm	0.74	12PCS
ML18-860-15W	15W	860x50x111	1950lm	0.96	12PCS
ML18-1140-20W	20W	1140x50x111	2430lm	1.18	12PCS

CCT — 3000K 4000K 5000K 5700K

Finish — White Black

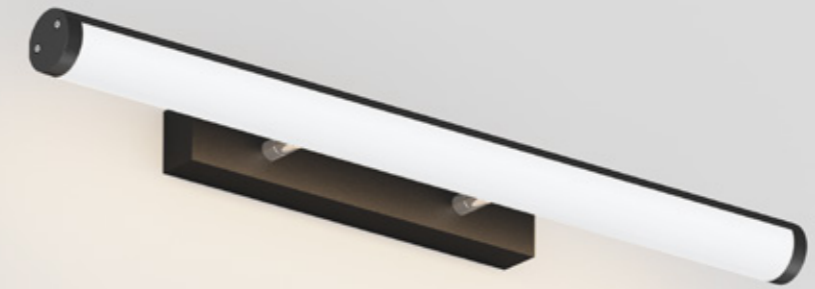

ML01 Mirror light

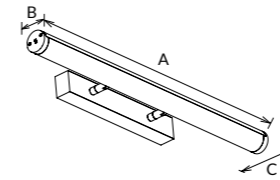

ML01 mirror light with concise and elegant design, adopting high transmittance PC lampshade, AL6063 aluminum lamp body, high lumen SMD LED with 110lm/W. Interchangeable CCT by slide switch is available, Brush Nickel/Chrome plated/Matt Black multiple finish color for option.

- ▶ 120° IP40
- ▶ Flicker Free SLIDE SWITCH 3 in 1
- ▶ AC 100-240V PF≥0.9 CRI≥80
- ▶ SAA RoHS CE

Code	Watt	Size(AxBxCmm)	Lumen(±5%)	N.W/pc(kgs)	Q'ty/CTN
ML01-580-10W	10W	580x41x111	1180lm	0.66	12PCS
ML01-860-15W	15W	860x41x111	1845lm	0.87	12PCS
ML01-1140-20W	20W	1140x41x111	2300lm	1.03	12PCS

CCT — 3000K 4000K 5000K 5700K

Finish — White Black Silver Nickel Brushed



LED Tube Light

/Series/

LED tube light more energy saving and high brightness are the first goal we are pursuing of all the time. Generous, simple and practical are what we have been working for. Brand Chip, CRI>80/ 90, high brightness more than 85LM/W, PC cover, Aluminum holder, EMI, EMC passed driver, high light transmittance are the main reason we win our reputation.

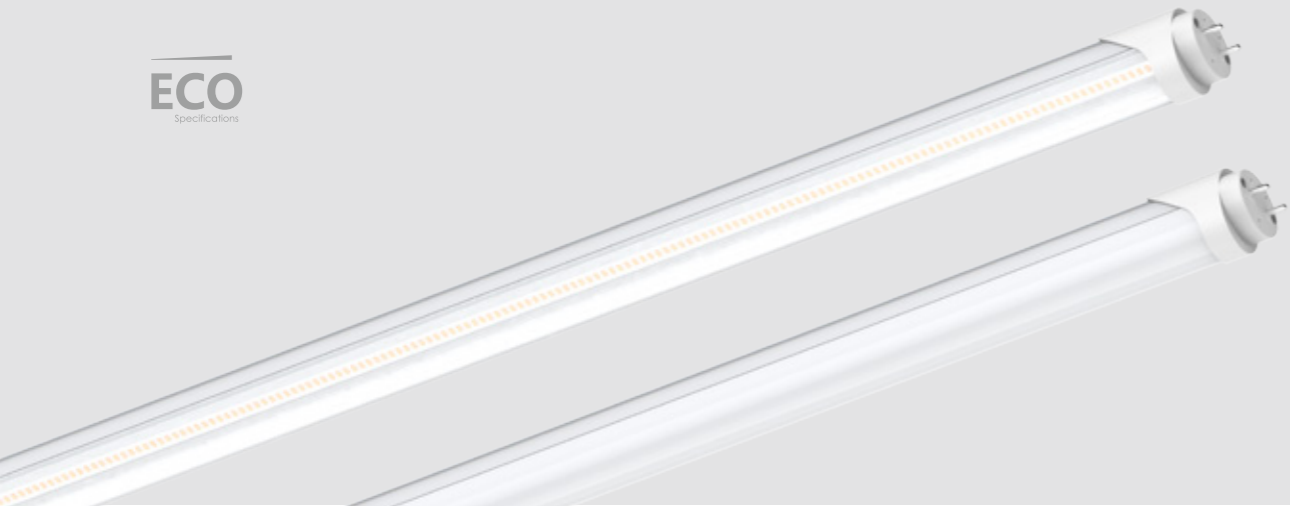

T8-AL+PC Tube light

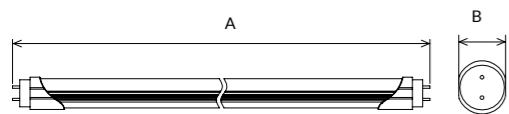

ELWA AL+PC LED Tube light adopts SMD LED with high brightness and slight light decay and V0 fire-rated PC cover, up to 95% light transmittance. Reliable LED driver with branded high quality capacitor and IC solution ensures excellent working performance.

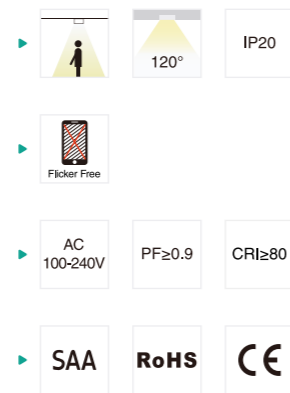

Code	Watt	Size(AxBmm)	Lumen(±5%)	N.W/pc(kgs)	Q'ty/CTN
T8-600-10W	10W	603xØ29.3	120lm/W	0.18	25PCS
T8-1200-18W	18W	1211xØ29.3	120lm/W	0.31	25PCS
T8-1500-25W	25W	1514xØ29.3	120lm/W	0.38	25PCS
T8-600-6W	6W	603xØ29.3	150lm/W	0.18	25PCS
T8-1200-12W	12W	1211xØ29.3	150lm/W	0.31	25PCS
T8-1500-15W	15W	1514xØ29.3	150lm/W	0.38	25PCS
T8-600-9W	9W	603xØ28.5	140lm/W	0.18	25PCS
T8-900-10W	10W	907xØ28.5	140lm/W	0.21	24PCS
T8-1200-18W	18W	1211xØ28.5	140lm/W	0.31	25PCS
T8-1500-23W	23W	1514xØ28.5	140lm/W	0.38	25PCS
T8-600-8W	8W	603xØ28.5	160lm/W	0.18	25PCS
T8-900-9W	9W	907xØ28.5	160lm/W	0.21	24PCS
T8-1200-16W	16W	1211xØ28.5	160lm/W	0.31	25PCS
T8-1500-20W	20W	1514xØ28.5	160lm/W	0.38	25PCS
T8-600-7W	7W	603xØ28.5	180lm/W	0.18	25PCS
T8-900-8W	8W	907xØ28.5	180lm/W	0.21	24PCS
T8-1200-14W	14W	1211xØ28.5	180lm/W	0.31	25PCS
T8-1500-16W	16W	1514xØ28.5	180lm/W	0.38	25PCS

CCT 3000K 4000K 5000K 5700K

Cover Clear Frosted



T8 PC Tube light

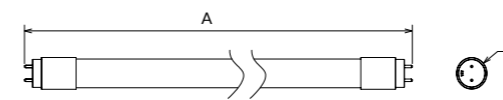

ELWA practical tube T8 adopts complete PC cover, using 2835SMD LED as light source, CRI>80. V0 fire-rated full PC cover ensures high light transmittance and safe installation. No yellowing and cracking.

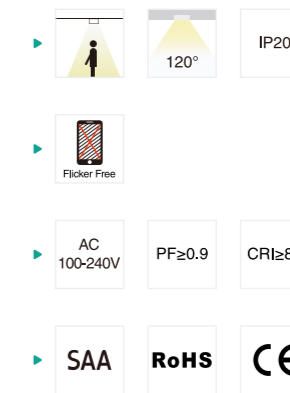

Code	Watt	Size(AxBmm)	Lumen(±5%)	N.W/pc(kgs)	Q'ty/CTN
T8-600-10W-AN	10W	603xØ26	1240lm	0.14	25PCS
T8-1200-18W-AN	18W	1213xØ26	1830lm	0.26	25PCS
T8-1500-20W-AN	20W	1513xØ26	2640lm	0.38	25PCS

CCT 3000K 4000K 5000K 5700K

Cover Frosted



T5-S Tube light

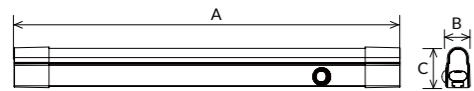

Integrated complete PC LED tube T5-S is a successful economic design. Adopt high lumen SMD LED as light source, full PC cover (pass 750C° glow-wire test) ensures high light transmittance and safe installation. Changeable CCT and IP42 protection level also make it easier maintenance. Special installation: Surface mounted and wall mounted with different accessories. Linkable design with connect wires or connect accessories, which is suitable for a wider application.



Code	Watt	Size(AxBxCmm)	Lumen(±5%)	N.W/pc(kgs)	Q'ty/CTN
T55W355-S	5W	355x22.3x37.4	535lm	0.18	50PCS
T58W600-S	8W	600x22.3x37.4	980lm	0.25	50PCS
T518W1200-S	18W	1200x22.3x37.4	2205lm	0.37	30PCS
T525W1500-S	25W	1500x22.3x37.4	3045lm	0.43	30PCS

CCT — 3000K 4000K 5000K 5700K

Cover — Frosted

T5-V Tube light

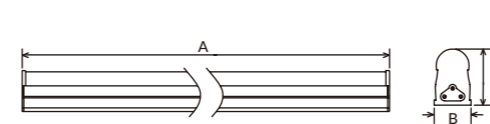

This is an integrated T5 tube. It adopts 2835 SMD light source and CRI > 80, combine with 94-V2 fire-rated PC shade to ensure a high transmittance and create a uniform light output. Besides, it is PC+Aluminum housing, which can realize high-efficiency lighting and good heat dissipation, with high cost performance through market.

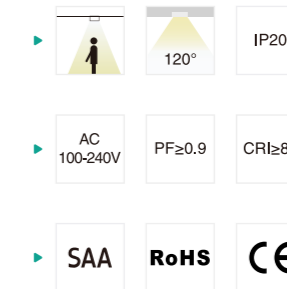

Code	Watt	Size(AxBxCmm)	Lumen(±5%)	N.W/pc(kgs)	Q'ty/CTN
T5-5W-300-V	5W	278x23x35	550lm	0.26	50PCS
T5-8W-600-V	8W	570x23x35	960lm	0.3	50PCS
T5-12W-900-V	12W	878x23x35	1440lm	0.34	30PCS
T5-18W-1200-V	18W	1178x23x35	2160lm	0.4	30PCS
T5-23W-1500-V	23W	1478x23x35	2760lm	0.45	30PCS

CCT — 3000K 4000K 5000K 5700K

Finish — Silver Oxide